

TEM

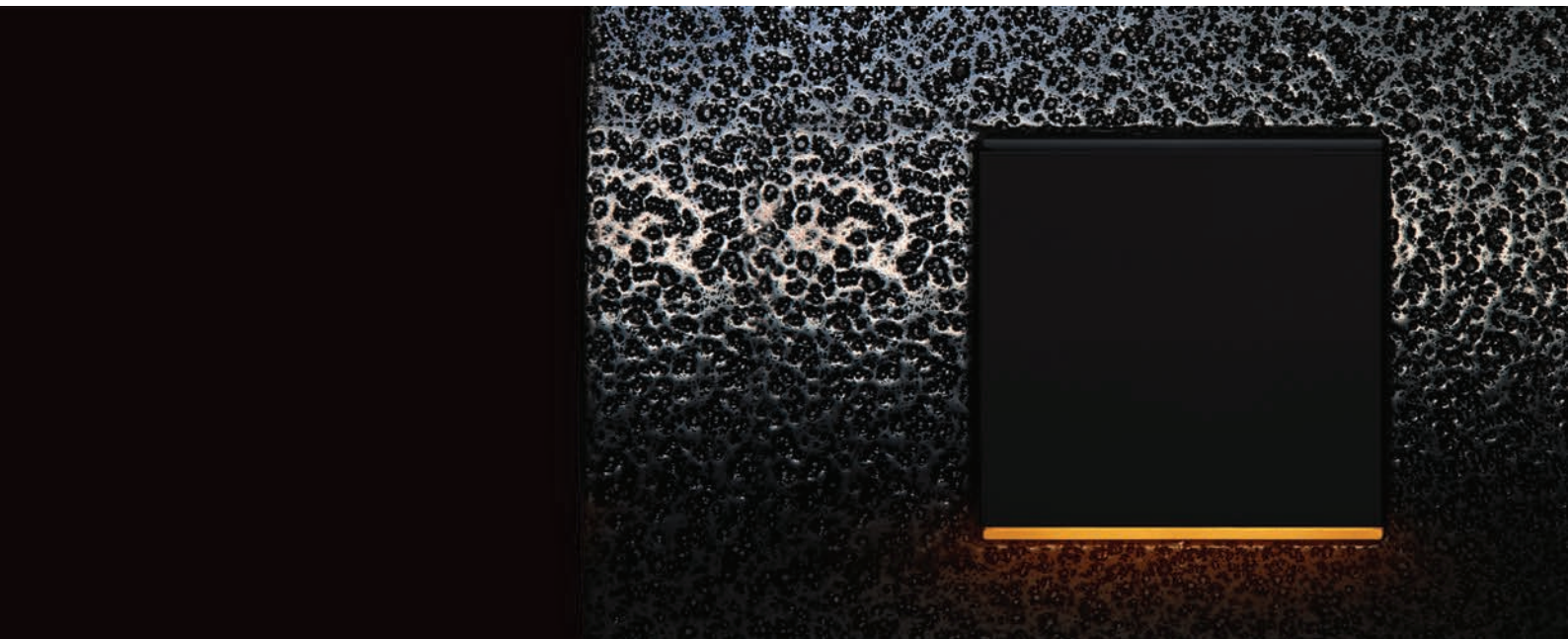

touching completeness

TEM



Willkommen bei der Familie Π O D U L

Welcome to the Π O D U L family

Für Sie ergänzen und vervollständigen wir die
moderne Schalterfamilie Modul für alle Arten von Räumen

We are expanding and perfecting the modern
Modul switch family for all types of rooms.

touching completeness

MODUL

Die Designlinien Pure, Line und Soft sind Ausdruck eines modernen, anspruchsvollen und individuellen Lebensstils. Aus der breiten und reichen Palette von Farben, Mustern und Formen können Sie Ihre Schalter und Steckdosen jederzeit einfach an das gewünschte Ambiente und die Atmosphäre anpassen.

The Pure, Line and Soft design lines reflect a modern, sophisticated and independent lifestyle. You can choose from a wide and rich selection of colours, patterns and shapes to alter the appearance of your switches and sockets so that they fit the desired atmosphere and mood.

PURE

natürliche Materialien
natural materials

Holz wood
Metall metal
Glas glass

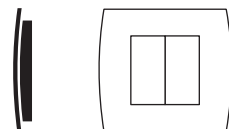

line

soft



gerade Linien
straight lines

weiche Linien
soft lines

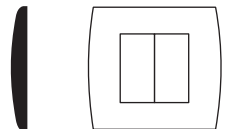
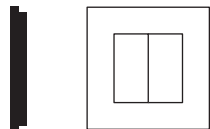

PURE



herrlicher Aufenthalt wonderful living

Aus reinen, unbefleckten Bildern der neu geborenen Welt entstand das Kapitel Pure. Wir verflechten den Hauch von Naturmotiven mit edlem Geschmack für Linien und verweben darin die Fäden der Spitzentechnologie.

From the cleanliness and purity of a new-born world stems the story of the Pure line. The touch of natural motifs is intertwined with a sophisticated taste for lines and form and interwoven with threads of state-of-the-art technology.



PURE

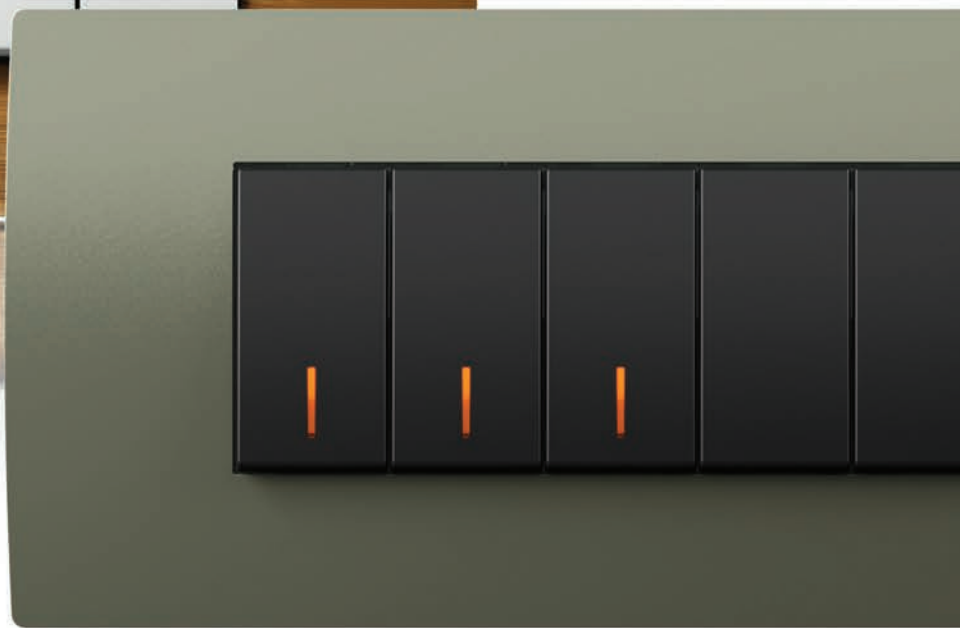



ein Gefühl der Natur feeling of nature

Die Linie der Schalter PURE zeichnet sich durch natürliche Materialien aus: Metall, Holz, Glas. Einen besonderen Touch verleiht das einzigartige Design. Es ist erkennbar und zugleich dezent. Ausgestrahlt werden Sinnlichkeit, Raffinesse, ein Höchstmaß an Standard und natürlich Reinheit.

The Pure switch line is distinguished by its natural materials: metal, wood and glass. Its unique design gives it a special touch. It is striking yet unobtrusive. It radiates sensuality, sophistication, high standards and, of course, cleanliness.

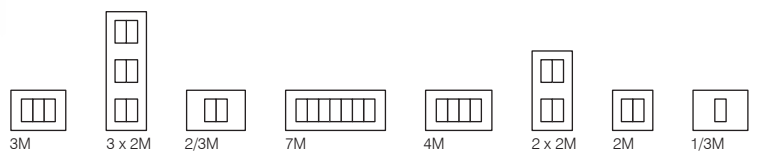

line



Harmonie der flachen Formen harmony of straight lines

Machen Sie sich bereit für die elegante Perfektion der flachen Formen. Erfahren Sie die Brillanz der Flächen, die sanft mit den modernen Elementen Ihrer Räume harmonisieren. Zur unverwechselbaren Optik hinzu kommt die Soft Touch-Technologie für angenehmen Schalt- und Bedienkomfort.

Get ready to witness the elegant perfection of straight lines. Experience the brilliance of surfaces that are completely harmonious with the modern elements of your room. The switches feature "Soft Touch" technology developed especially for you to make every touch a wonderful experience.



line

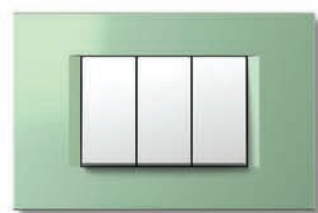
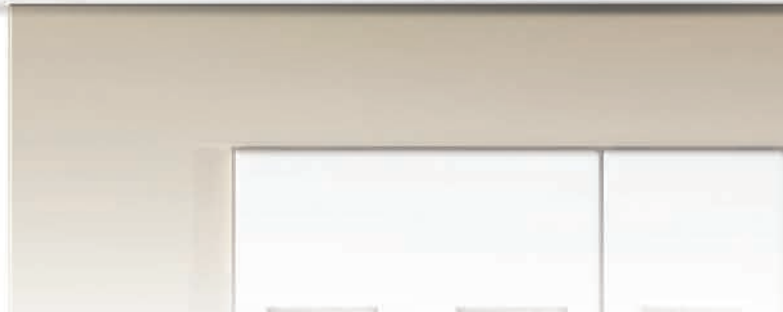
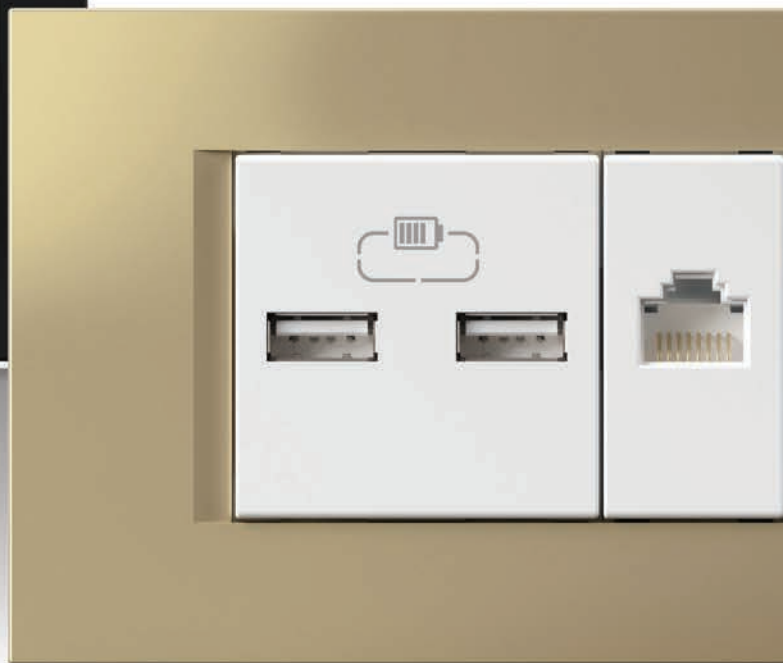

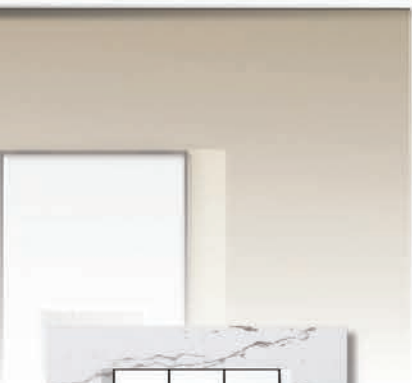

modernes Design

modern design

Reine, gerade Linien schaffen ein zeitloses Design. Ein vollkommenes, flach geformtes dünnes Profil und die Ergonomie von Soft Touch ergeben eine hervorragende Optik aus allen Seiten.

Its straight, smooth lines make for a timeless design. Its perfectly straight, sleek profile and soft-touch ergonomics give it an amazingly elegant appearance from all angles.



soft



Geschmeidigkeit für Ihr Zuhause

softness in your home

Lassen Sie durch die abgerundeten Formen und weichen Übergänge Geschmeidigkeit in Ihr Zuhause bringen.

Let the rounded shapes and soft transitions bring softness into your home.



soft





Wärme des eigenen Heims a warm home

Die Perfektion der weichen Formen wird durch die subtile Auswahl von Farben und besonderen Beschichtungen ergänzt, die Sie bei jeder Berührung wahrnehmen.

Perfectly soft shapes rounded off by a subtle selection of colours and special coatings for a special touch.

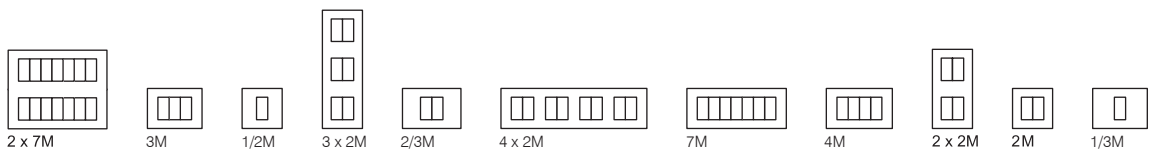

der Universaldimmer

universal dimmer

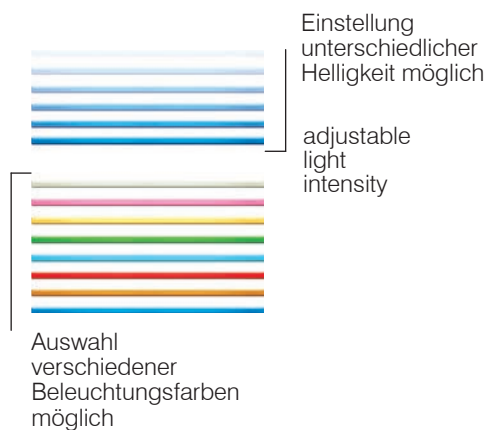
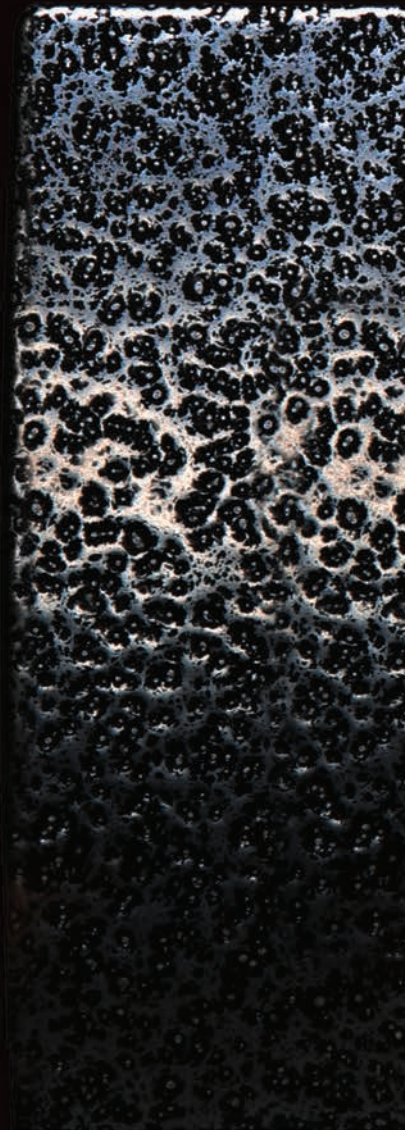

In der Dunkelheit wird Touch zur eleganten Ambientleuchte zur Markierung der Schalterposition und sanften Beleuchtung des Raumes. Sie können einen der acht verschiedenen Farbtöne der sanften Beleuchtung auswählen und die Helligkeit beliebig Ihrer Stimmung anpassen

In the dark Touch becomes a tender soft ambient light. It marks the spot of a switch and gently illuminates a place. You can choose among eight different colours of tender light and adapt its brightness according to your mood.



ein noch nie da gewesenes Licht light as never seen before

Gedämpftes Licht schafft eine Atmosphäre des Friedens, der Sinnlichkeit und der Romantik. Es ist ein Zeichen von romantischen Cafés und ruhigen spätabendlichen Stunden zu Hause oder am Arbeitsplatz. Die verzögerte sanfte Einschaltung verlängert nicht nur die Lebensdauer der Leuchtmittel, auch wird die Dunkelheit viel angenehmer und langsamer durch das Licht ersetzt. Durch Touch kann das Licht unabhängig vom Lampen- und Leuchtmitteltyp überall verdunkelt werden.

A dimmed light makes peaceful, sensual and romantic atmosphere. It is a trade mark of romantic places and quiet late evening hours spent at home or at work. Switching is soft and extended. It does not only prolong the lamp life expectancy, but also changes darkness into light in a slower and much more pleasant way. Touch enables you to dim the light anywhere, regardless of the type of lamps.





Alles an einer Stelle

everything in one place

Ihr Haus ist ein Lebenszentrum geworden. Die verschiedensten Geräte verlangen eine Menge von Anschlüssen und Steckdosen. Bauen Sie sich ein eigenes Multimediazentrum mit Möglichkeiten zum Anschluss und zur Bedienung mehrerer verschiedener Komponenten an einer Stelle.

Your house is the centre of your life. The multitude of devices you use requires a number of connectors and sockets. Create your own multimedia centre, one that will allow you to connect and use a multiple number of different components in one place.

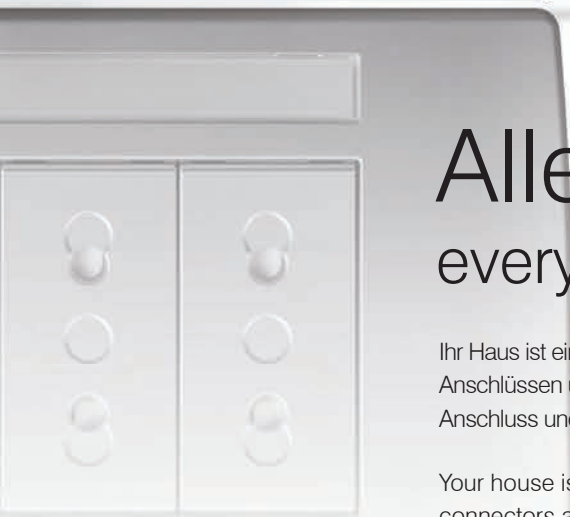



innovativer Temperaturregler

innovative temperature controller

Sorgen Sie für Ihren Komfort und regeln Sie die Temperatur in Ihren Wohn- und Arbeitsräumen mit einem intelligenten Thermostaten. Sie können sowohl Heiz- als auch Kühlanlagen steuern und haben auch die Möglichkeit einer ökonomischen Betriebsart.

Make yourself comfortable by controlling the temperature in your living and working rooms during all seasons with a smart thermostat. It allows you to control heating and cooling devices and features an eco-function.

der Raumkomfort

comfort in your room



moderne Beleuchtung

modern illumination





3D-Lampe

3D lamp

Das schnelle Tempo des Lebens bringt eine Menge an Informationen. Die 3D-Farblampe ist eine elegante Lösung für die Kennzeichnung, Lenkung und Kommunikation. Die Grafik erstellen wir nach Ihrem Wunsch.

The rapid pace of life means you are constantly being bombarded with plenty of information. 3D colour lamp provides an elegant solution for information and direction signs. We can make graphics according to your wishes.



ARX – keine Schlüssel mehr

ARX – say goodbye to keys

ARX ONE ermöglicht Ihnen einen sicheren und komfortablen Eintritt in Wohnung, Haus oder Arbeitsraum. Ein Ziehen mit dem Finger genügt, um die Tür zu öffnen. ARX ONE ist eine selbstständige Einheit, die zur Bedienung keine Anbindung an den PC benötigt.

The ARX ONE allows you to gain access to your apartment, house or office securely and conveniently. It takes only a swipe of the finger to unlock the door. It functions as an independent unit and requires no computer connection.

erhöhte Sicherheit

improved security



Individualität

individuality



bauen Sie sich Ihre eigenen

make it your own

Seien Sie anders. Gönnen Sie sich Schalter nach Ihrem Maß. Wählen Sie zwischen den verschiedenen Farben der Rahmen oder lassen Sie uns Ihre Schalter durch beliebige Grafiken und Beschriftungen dekorieren. Wählen Sie eine Farbe der Beleuchtung, die zu Ihrem Ambiente passt.

Be different. Make a switch according to your taste. You can choose between different frame colours and we can decorate them for you with custom graphics or signs. Choose an illumination colour that suits the ambience of your room.



modular modularity

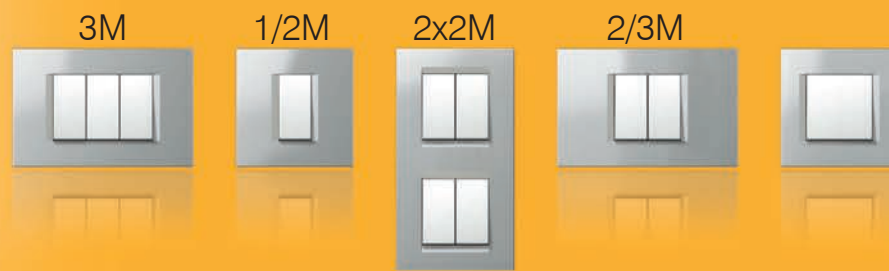

Wir haben für ein ganzheitliches System gesorgt. Sie finden hier alle Elemente für jede beliebige Zusammensetzung. Das System besteht aus Grundelementen – Modulen, die Sie horizontal oder vertikal untereinander kombinieren können.

We have designed a comprehensive system that features a variety of elements, allowing you to create any configuration you wish. The basic elements of the system are modular and can be combined horizontally or vertically.



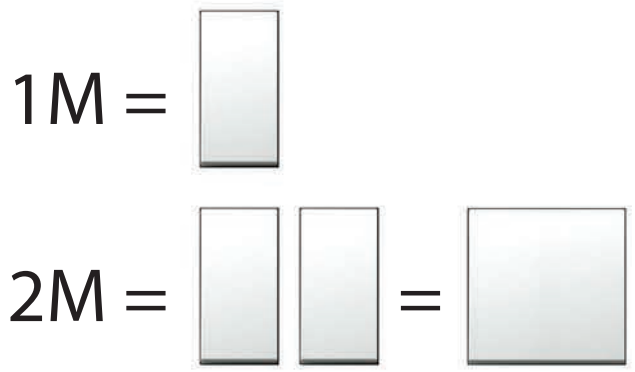
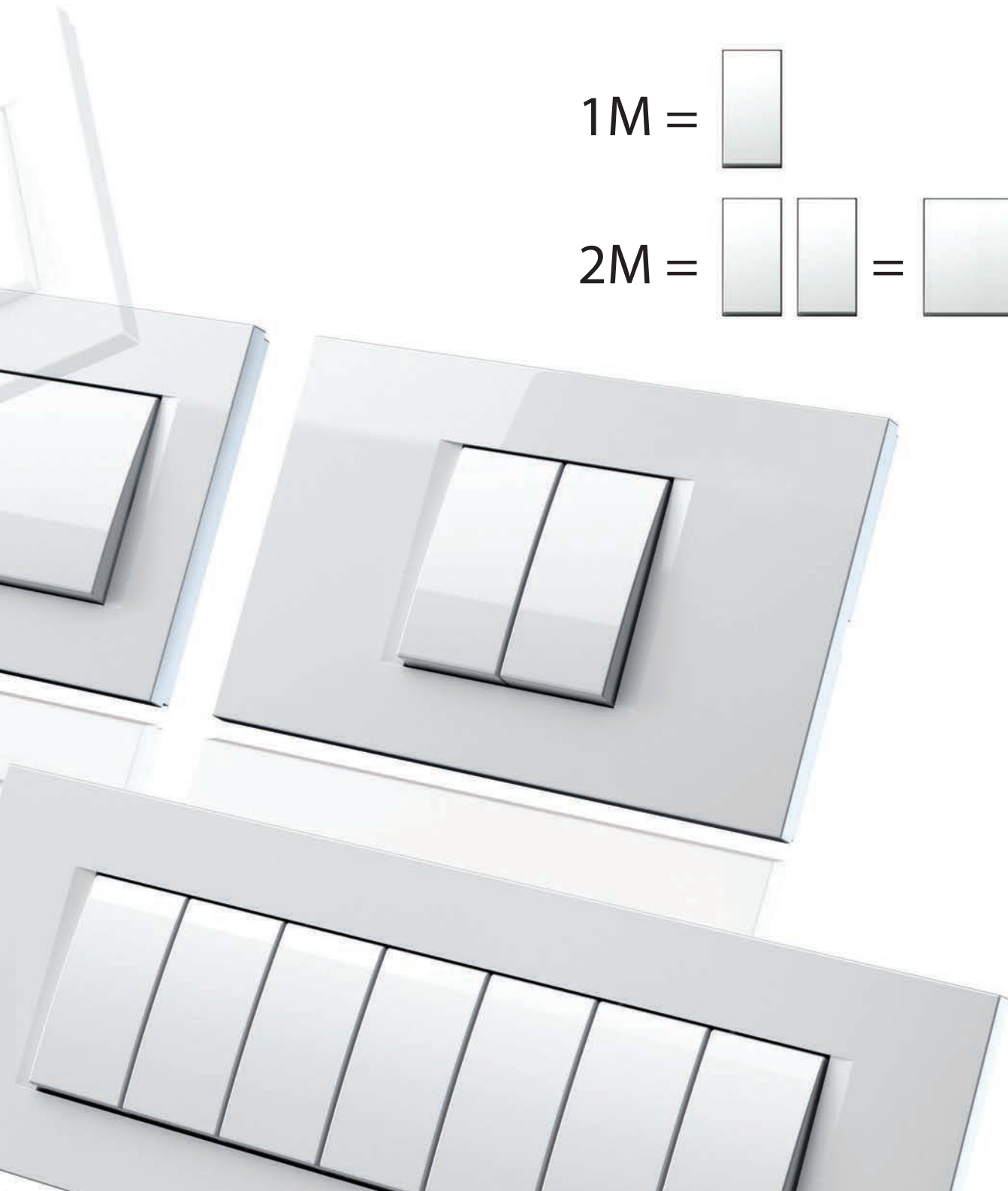
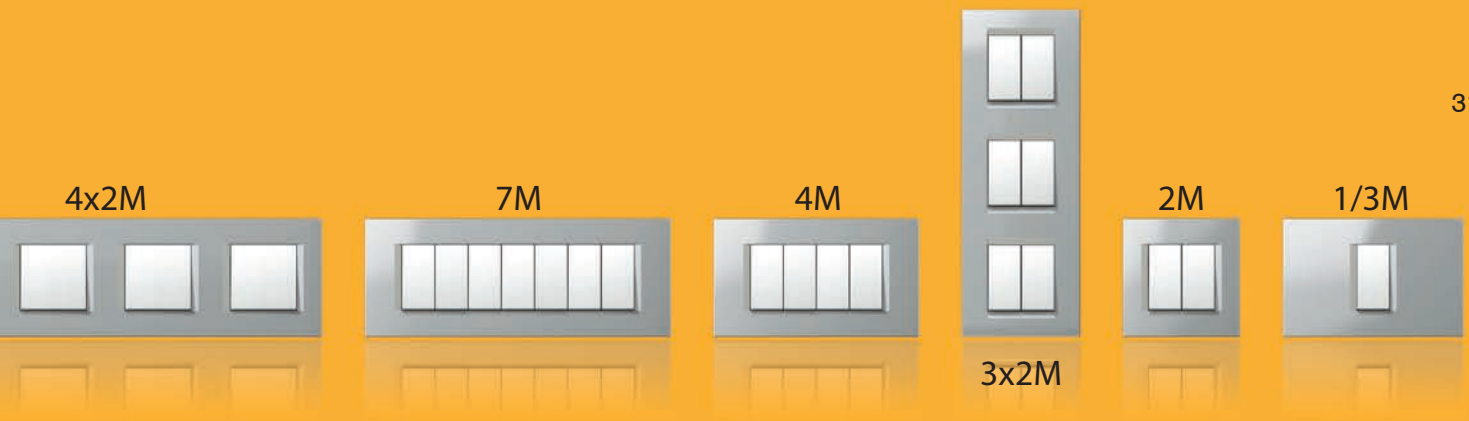

universell

universality

Das System zeichnet sich durch die vollkommene Auswahl an Elementen und durch einen einfachen Einbau aus. Ein Set von Schaltern kann auf verschiedenste Weisen in den Raum eingefügt werden, sei es in einer runden oder rechteckigen Dose, selbstständig oder im Satz.

The system features a comprehensive selection of elements and is easy to install. Switch sets can be positioned in many different ways, regardless of whether the box is round or rectangular, individual or serial.



modulmanager.tem.si



Nutzen Sie den ModulManager, der Ihnen hilft, beliebige Kombinationen zusammenzusetzen.

Try out the "ModulManager" tool, which will help you put together any combination you want.

Lösungen für 4 Schalter

solutions for 4 switches

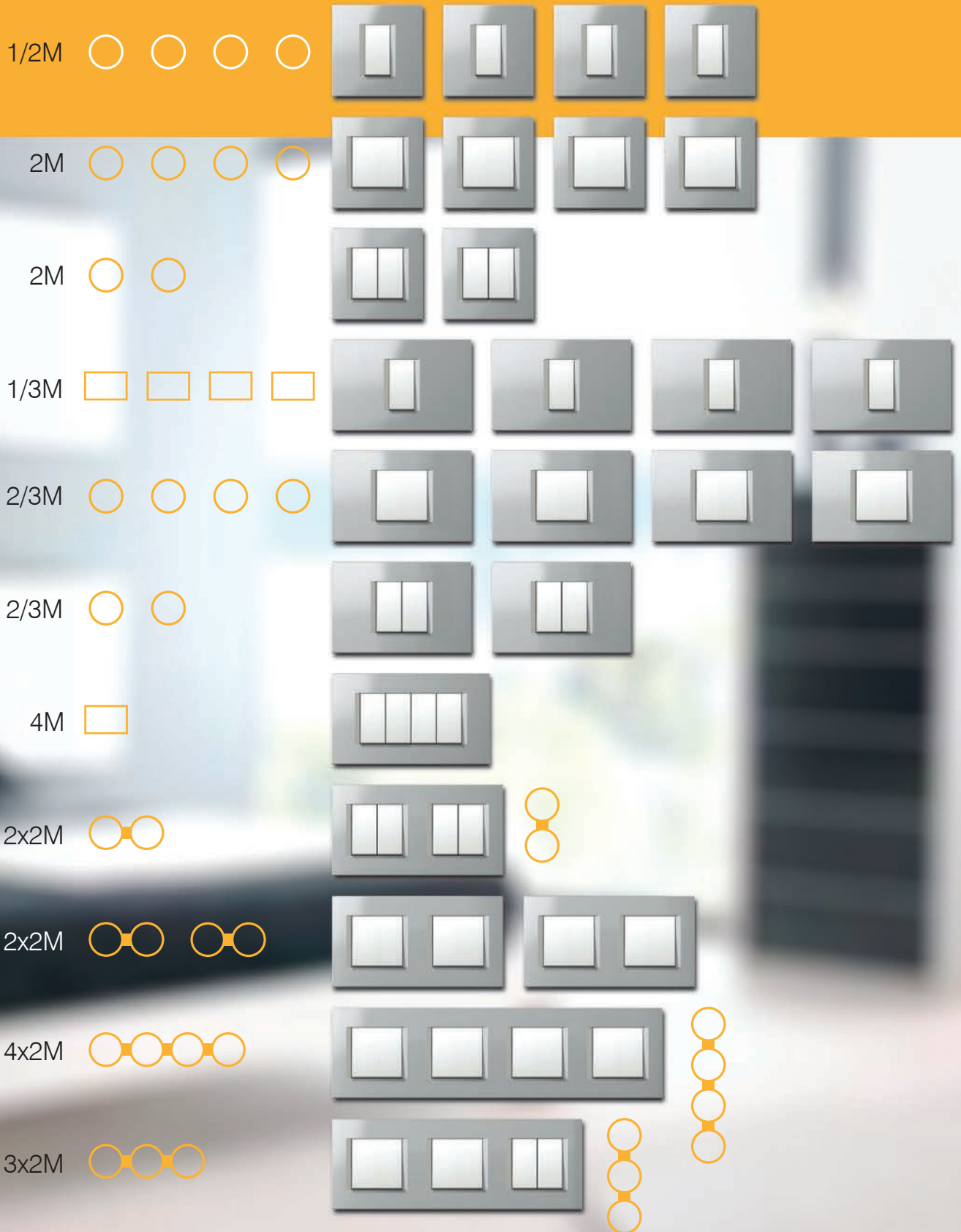

funktionell

functionality

Modul ist konzipiert für alle, die ein durchdachtes Produkt zu schätzen wissen. Das System benötigt weniger Platz, da im gewissen Rahmen eine beliebige Kombination von Funktionselementen zusammengesetzt werden kann. Damit ist es für Neubauten genauso geeignet wie für Umbauarbeiten und Adaptionen.

The Modul was developed for those who can appreciate a thoughtfully designed product. The system takes up less space, as any combination of function elements can be fitted inside the same cover plate. It is suitable for new, as well as renovated buildings.



Modul Soft auch in der antibakteriellen Ausführung AW.

The Modul Soft is also available in an antibacterial solution AW.

dekorative Rahmen
decorative cover plates



—line—

—soft—

PURE



Funktionselemente
function elements

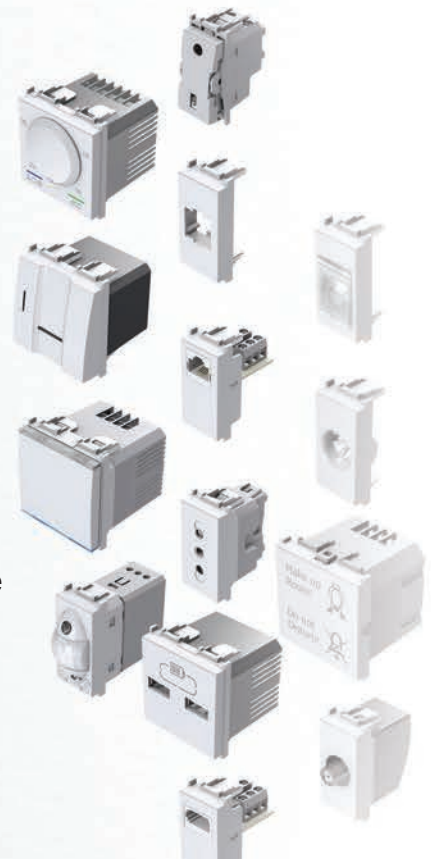

einfach simplicity

Die Funktionselemente werden einfach an dem Träger befestigt. Für Sie haben wir die Klick-Ein-Klick-Aus-Lösung entwickelt, die wesentlich zur Verkürzung der Montagezeit beiträgt. Die Anschlusskontakte sind von der Vorderseite leicht erreichbar.

The function elements are easily fitted inside the mounting frame. The "klik-in, klik-out" solution we have developed for you will reduce installation time. The connection contacts are easily accessible from the front.

line
soft
PURE

Klick-Ein, Klick-Aus

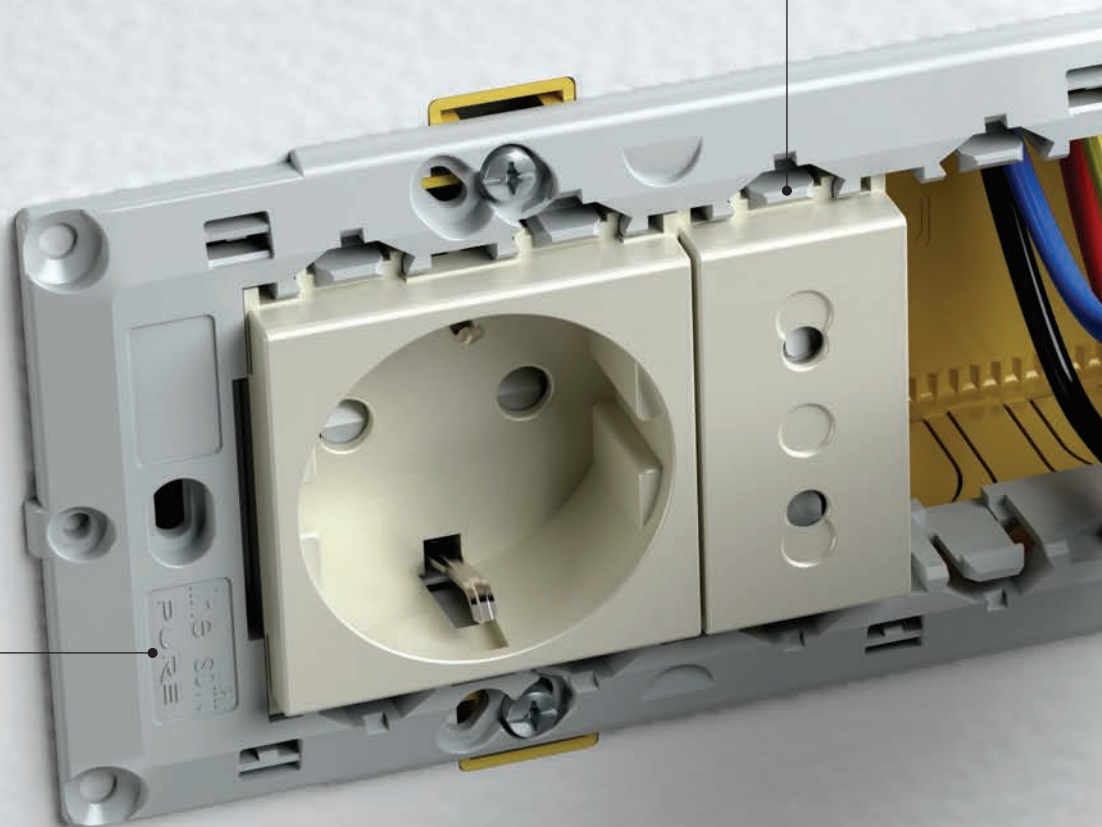

Klick-Aus – einfach und schnell, ohne zu schrauben.

"klik-out" - simple and quick, no screws necessary.

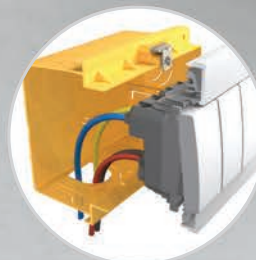

In rechteckigen Dosen ist mehr Platz für Anschlussleitungen.

Rectangular boxes have more space for connection wires.

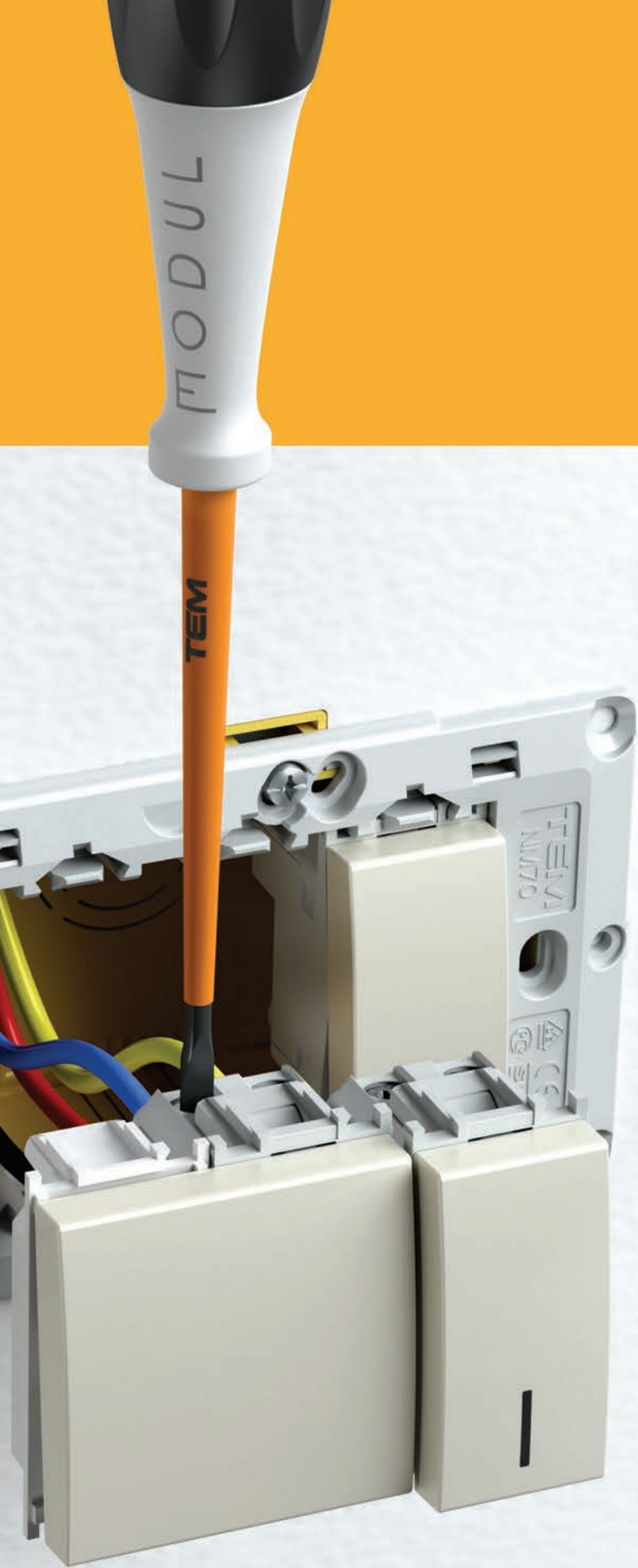

~~line~~

soft

PURE

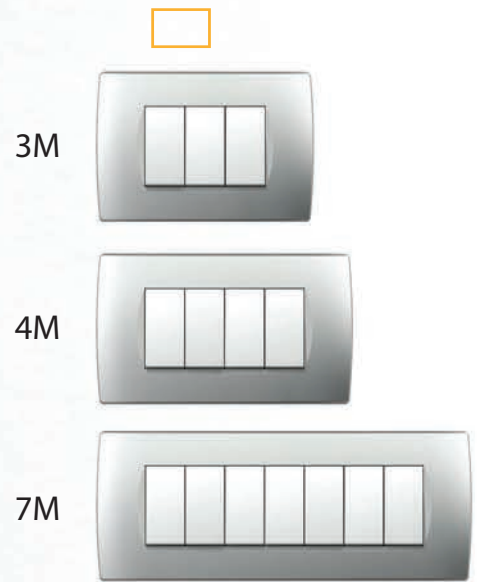

3M

4M

7M

zusammensetzbar

combinability

Modul bietet Ihnen viele Möglichkeiten auch durch die Verwendung von Runddosen. Sie können horizontal, vertikal, selbstständig oder im Satz kombinieren. Der Metallträger gewährleistet eine hervorragende Stabilität auch beim Grobeinsatz und ist für alle dekorativen Rahmen geeignet.

The Modul enables many possibilities even with round boxes. You can combine them horizontally or vertically, individually or in groups. The metal mounting frame ensures excellent stability even with rough use and is suitable for any decorative cover plates.

line
soft
PURE

Klick-Ein, Klick-Aus

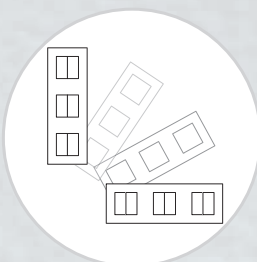
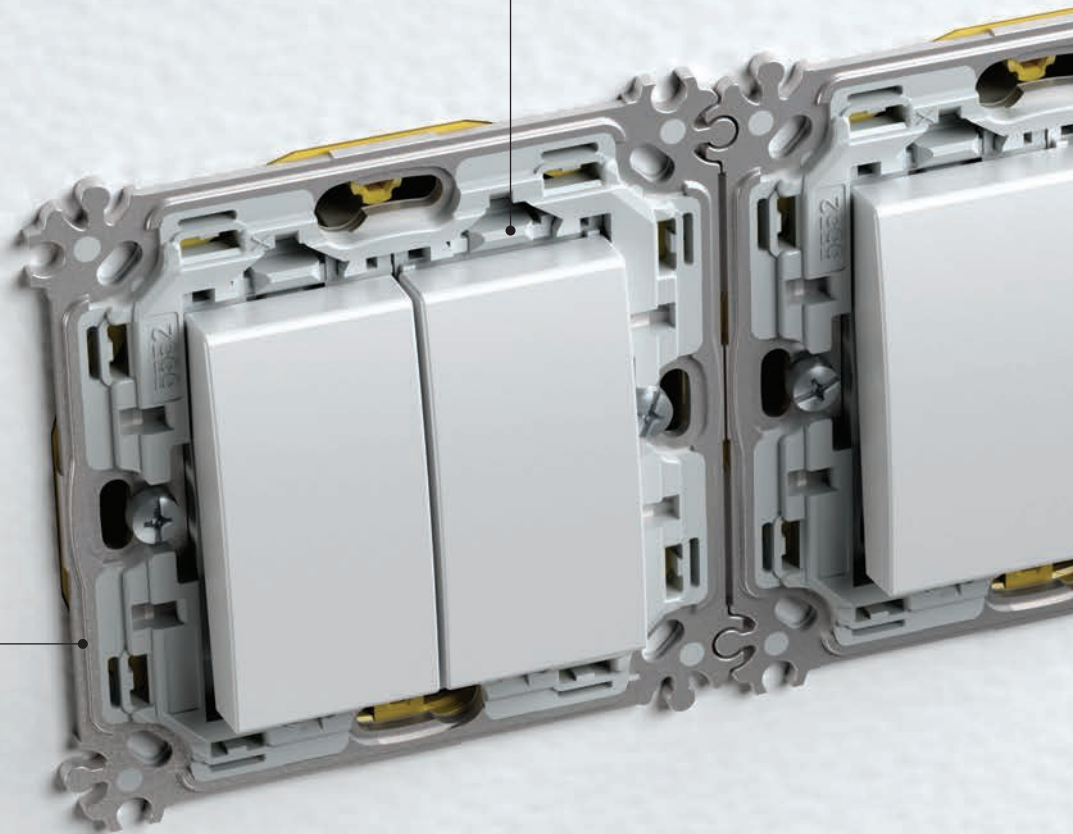

Der gleiche Rahmen kann sowohl horizontal als auch vertikal eingesetzt werden.

The same cover plate can be positioned horizontally or vertically.

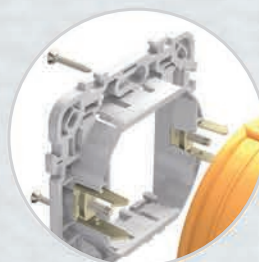

Die Montageträger sind zur Schrauben- oder Krallenbefestigung geeignet.

Mounting frames can be fixed with screws or claws.



line

soft

PURE



2M



2x2M



3x2M



4x2M



Montageträger in der Größe 2M können durch einfache Umschaltung zu größeren Gruppen verbunden werden.

2M mounting frames are easily joined into groups.

universell

universality

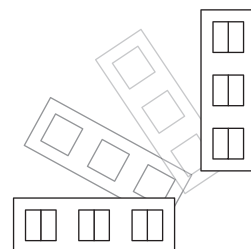
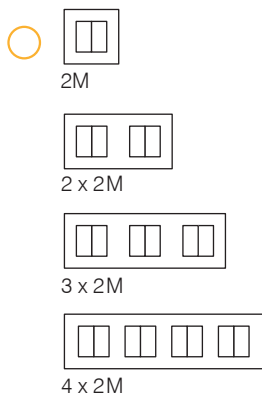
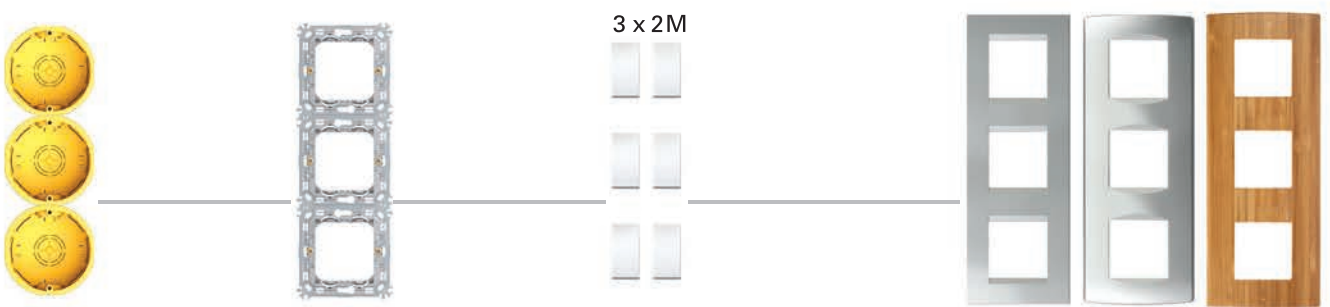
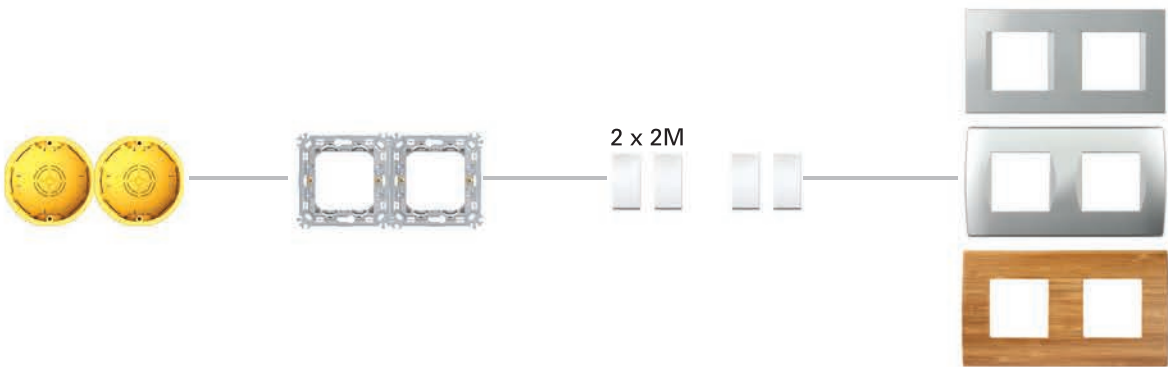
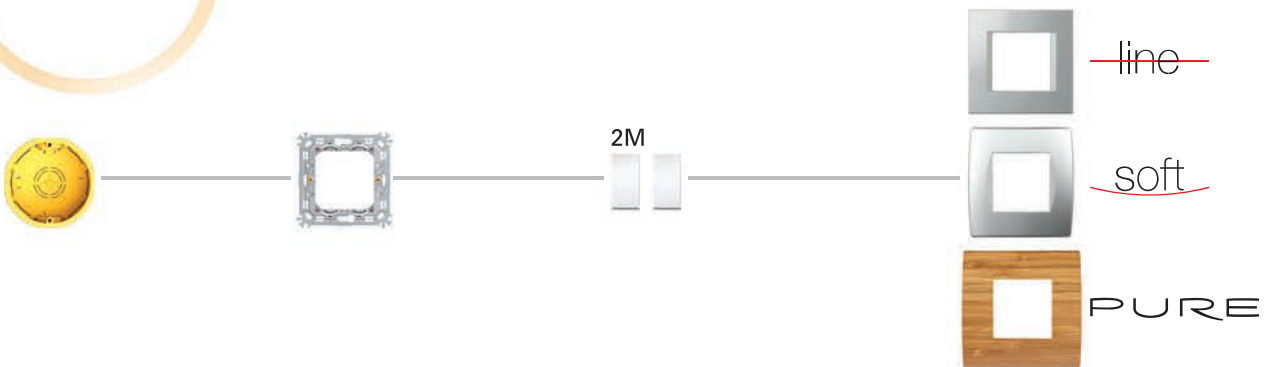

Ein Universalsystem – geeignet für den Einbau sowohl in Rund - als auch in Rechteckdosen.

The system is universal and can be fitted in both round and rectangular boxes.

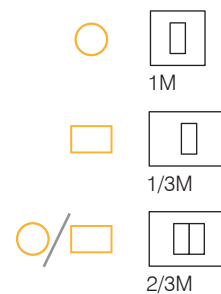
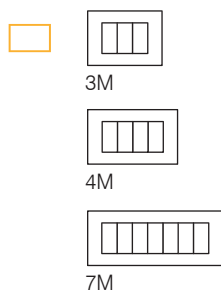
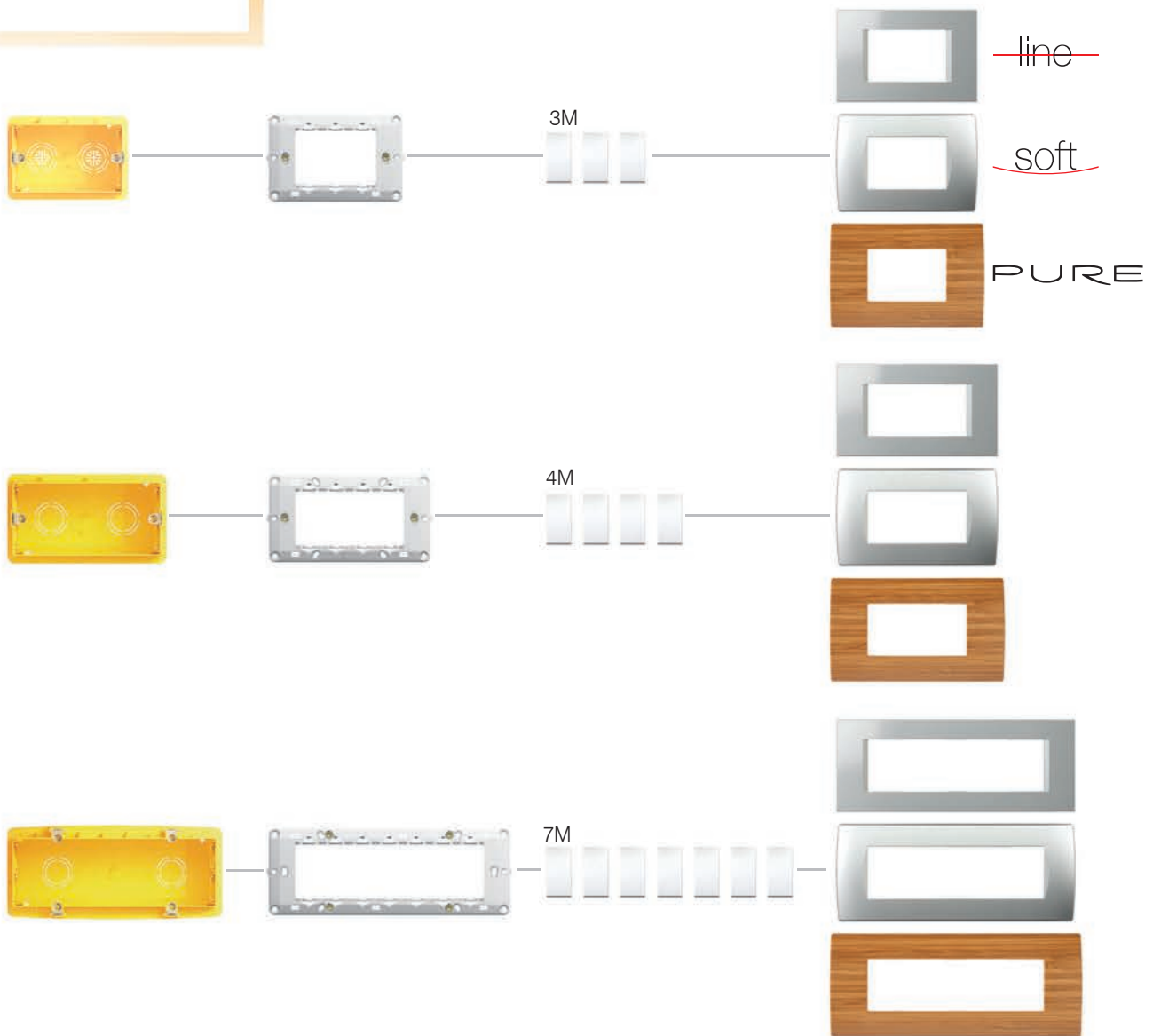

Funktionselemente

function elements

• Schalter / switches



• Eingang / entrance

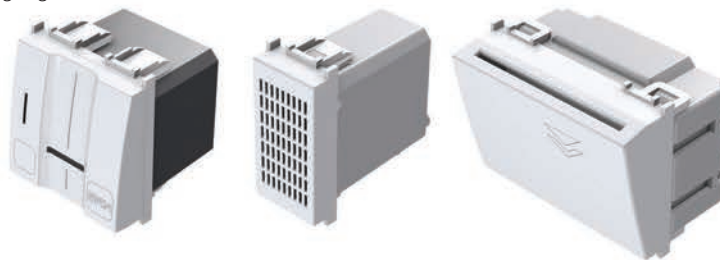

MODUL

• Energiesparen / energy saving

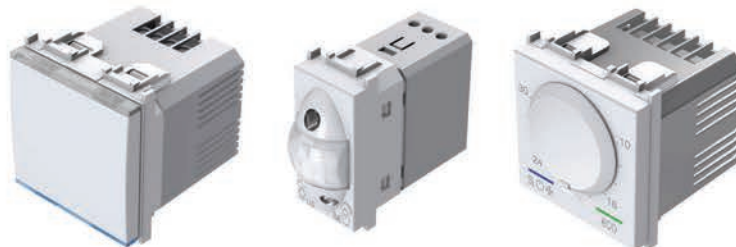

Zuverlässiger und einfacher Anschluss der Leiter in verschiedenen Durchmessern.

Reliable connection even when different size of wires are used.



Lange Lebensdauer und Konformität mit aktuellen Normen.

Long-life of switches and adequacy to the international standards.

Wir haben für eine breite Palette an Funktionselementen in der Modul-Familie gesorgt. Dadurch können Sie sowohl einfache als auch anspruchsvolle Installationen planen.

We have designed a wide selection of function element for the Modul family. You can use them to design both simple and complex installations.

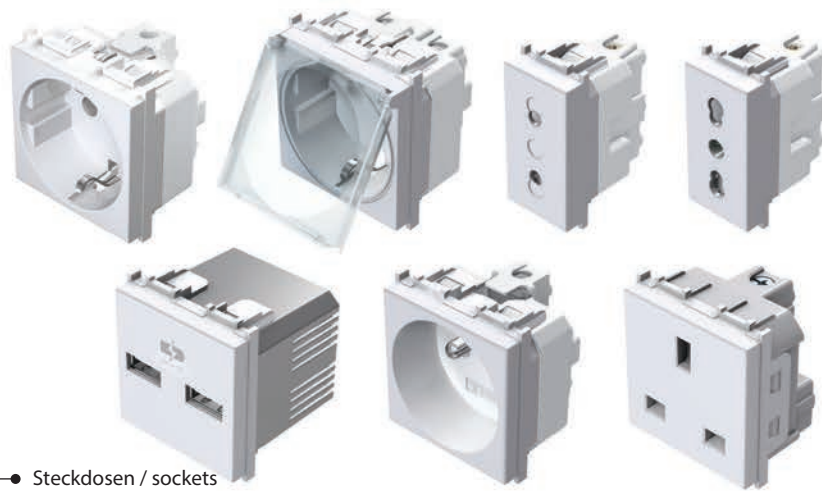

- Steckdosen / sockets
- Vergnügen / entertainment
- Beleuchtung / illumination



Alle Steckdosen verfügen über einen integrierten Berührungsschutz (Kinderschutz).

All the sockets are equipped with a safety shutters assuring the protection to live contacts.



Silberne Kontakte garantieren zuverlässiges Schalten.

The switch is highly reliable via its silver rivets contacts.

Einzigartiges Anwendungsspektrum

unique range of usability

Modul Soft AW
antibakterielle Ausführung /
antibacterial solution



MODUL

CUBO IP20

Aufputzgehäuse
surface mounted boxes



CUBO IP55

Aufputzgehäuse
surface mounted boxes



IP44

Unterputzgehäuse
flush mounted



Geht es um eine Ausstattung für Zuhause, Büros oder Werkstätten? Modul ist für Wohn- und Arbeitsräume in privaten und öffentlichen Gebäuden geeignet. Einzigartig daran ist, dass Sie die Schalter und Steckdosen dort einbauen können, wo Sie diese benötigen.

Are you furnishing your home, office or workshop? The Modul is suitable for living as well as working spaces and both private and public buildings. It is unique in that the switches and sockets can be fitted wherever they are needed.

D

Ziegelwand
brick



H

Hohlwand
hollow wall



B

Betonwand
concrete

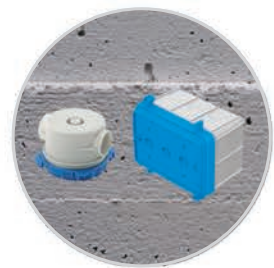

• Funktionselemente /
function elements

Schalter / switches
Steckdosen / sockets
Kommunikation / communications
Sensoren / sensors
Regler / regulators
Beleuchtung / illuminations

MA

Brüstungskanäle
trunking systems



MO

Verteilerkasten
distribution boards



MT

Bodendosen
floor boxes



Unterputzlösungen

flush mounted solutions

Ziegelwand / brick

Modul kann in alle Wandarten eingebaut werden, sei dies eine klassische, Trockenbau- oder eine Betonwand. Der Einbau ist einfach und bietet Ihnen die Möglichkeit des Zusammenbaus von runden oder rechteckigen Dosen in beliebigen Abständen. Die verwendeten Materialien werden nach hohen Normen geprüft.

The Modul is suitable for all wall types and can be used in conventional, hollow wall or concrete constructions. It is easy to install and enables you to combine rectangular or round boxes at the proper distances. The materials used are compliant with high standards.





Weitere Lösungen

other solutions

IP44
Unterputzgehäuse
flush mounted

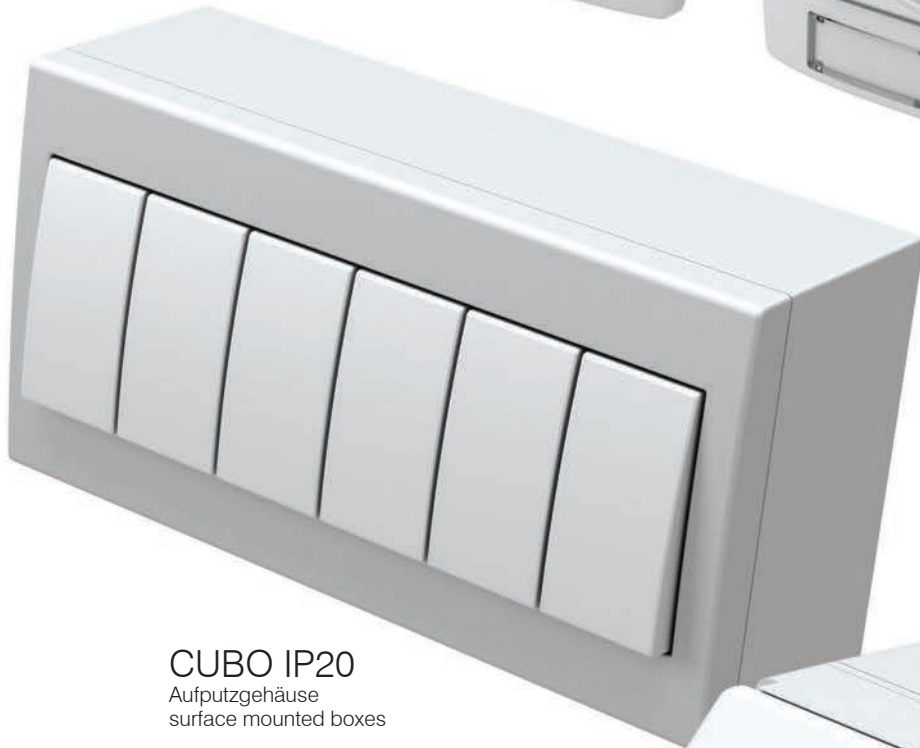

CUBO IP20
Aufputzgehäuse
surface mounted boxes

CUBO IP55
Aufputzgehäuse
surface mounted boxes



Brauchen Sie einen Schalter oder eine Steckdose in Unterputz-, Aufputz- oder Bodenausführung? Modul bietet verschiedene Einbaulösungen, in verschiedenen IP-Schutzarten, in Brüstungskanälen, Verteilerkästen oder Bodendosen. Die Auswahl liegt bei Ihnen.

Do you need switch or socket in flush, surface or floor solution? The Modul provides different mounting solutions with different IP protections, for trunking systems, distribution boards or floor boxes. The choice is yours.



MA

Brüstungskanäle
trunking systems

MO

Verteilerkasten
distribution boards

MT

Bodendosen
floor boxes

Produktkatalog

technical catalogue





MODUL

— Funktionsmodule
functional modules



54

Design
design

PURE
~~line~~
soft

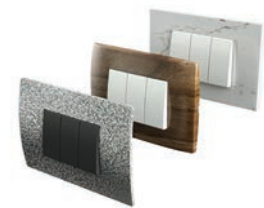

96

Dosen
boxes



118

Vertrieb
distribution



140

TEM



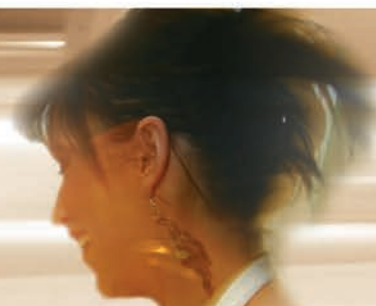

FUNKTIONSMODULE

FUNCTION ELEMENTS

SCHALTER SM
SWITCHES SM



54

WIPPE TM
BUTTONS TM



59

BELEUCHTUNG IA
ILLUMINATION IA



62

STECKDOSEN VM
SOCKETS VM



64

KOMMUNIKATION KM
COMMUNICATIONS KM



68

KOMMUNIKATIONSZUBEHÖR KA
COMMUNICATION ACCESSORIES KA



74

ELEKTRONIK EM
ELECTRONICS EM



76

SETS CM
SETS CM



89

ANTIBAKTERIENPROGRAMM AW
ANTIBACTERIAL PROGRAM AW



92

FORM

DESIGN

RAHMEN PURE OP
COVER PLATES PURE OP



96

RAHMEN LINE OL
COVER PLATES LINE OL



100

RAHMEN SOFT OS
COVER PLATES SOFT OS



104

MONTAGETRÄGER NM
MOUNTING FRAMES NM



112



SM11

PW

IN

01

Typ type	Bezeichnung description	Tech. daten technical data	Größe size	Farbe colour	Optionsbez. 1 optional data 1	Optionsbez. 2 optional data 2
SM10	SCHALTER 1-POLIG SWITCH 1WAY	16AX 250V~	1M	<input type="checkbox"/> PW Weiß-glänzend polar white	<input type="checkbox"/> NT neutral neutral	01
SM11	TASTER 1-POLIG PUSH BUTTON 1WAY	16A 250V~	1M	<input checked="" type="checkbox"/> SB Schwarz-matt soft touch black	<input type="checkbox"/> IN indikator indicator	02
SM12	SCHALTER 1-POLIG SWITCH 1WAY	20A 250V~	1M	<input type="checkbox"/> ES Silber-matt elox silver		03
.	.	.	.	<input type="checkbox"/> IW Beige-glänzend ivory white		.

SCHALTER 1-POLIG 16AX 250V~ 1M



SM10

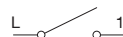

- Schalter ohne Wippe
- 16AX 250V~, Typ SM10
- entspricht EN 60669-1
- Schraubklemmen 1,5-2,5 mm²

SWITCH 1WAY 16AX 250V~ 1M
 - switch without button
 - 16AX 250V~, type SM10
 - in accordance with EN 60669-1
 - screw contacts 1.5-2.5mm²

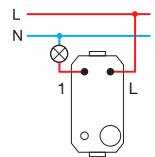

TASTER 1-POLIG 16A 250V~ 1M



SM11



- Taster ohne Wippe
- 16A 250V~, Typ SM11
- entspricht EN 60669-1
- Schraubklemmen 1,5-2,5 mm²

PUSH BUTTON 1WAY 16A 250V~ 1M
 - push button without button
 - 16A 250V~, type SM11
 - in accordance with EN 60669-1
 - screw contacts 1.5-2.5mm²

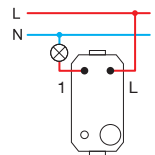

SCHALTER 1-POLIG 20A 250V~ 1M



SM12



- Schalter ohne Wippe
- 20A 250V~, Typ SM12
- entspricht EN 60669-1
- Schraubklemmen 1,5-2,5 mm²

SWITCH 1WAY 20A 250V~ 1M
 - switch without button
 - 20A 250V~, type SM12
 - in accordance with EN 60669-1
 - screw contacts 1.5-2.5mm²

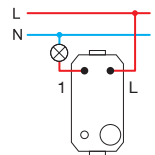

SCHALTER 2-POLIG 16AX 250V~ 1M



SM20

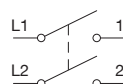

- Schalter ohne Wippe
- 16AX 250 V~, Typ SM20
- entspricht EN 60669-1
- Schraubklemmen 1,5-2,5 mm²
- Nur in Kombination mit Wippe TM15

SWITCH 2POLE 16AX 250V~ 1M
 - switch without button
 - 16AX 250V~, type SM20
 - in accordance with EN 60669-1
 - screw contacts 1.5-2.5mm²
 - only in combination with button TM15

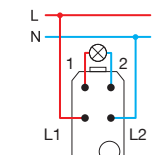

SCHALTER JALOUSIE 1-0-2 16AX 250V~ 1M



SM40

- Schalter ohne Wippe
- 16AX 250V~, Typ SM40
- entspricht EN 60669-1
- Schraubklemmen 1,5-2,5 mm²

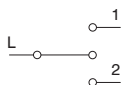

SWITCH SHUTTERS 1-0-2 16AX 250V~ 1M

- switch without button
- 16AX 250V~, type SM40
- in accordance with EN 60669-1
- screw contacts 1.5-2.5mm²

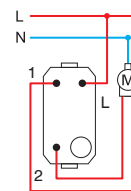

TASTER JALOUSIE 1-0-2 16A 250V~ 1M



SM41

- Taster ohne Wippe
- 16A 250V~, Typ SM41
- entspricht EN 60669-1
- Schraubklemmen 1,5-2,5 mm²

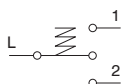

PUSH BUTTON SHUTTERS 1-0-2 16A 250V~ 1M

- push button without button
- 16A 250V~, type SM41
- in accordance with EN 60669-1
- screw contacts 1.5-2.5mm²

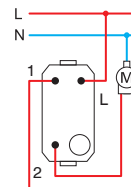

SCHALTER WECHSEL 16AX 250V~ 1M



SM60

- Schalter ohne Wippe
- 16AX 250V~, Typ SM60
- entspricht EN 60669-1
- Schraubklemmen 1,5-2,5 mm²

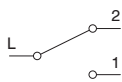

SWITCH 2WAY 16AX 250V~ 1M

- switch without button
- 16AX 250V~, type SM60
- in accordance with EN 60669-1
- screw contacts 1.5-2.5mm²

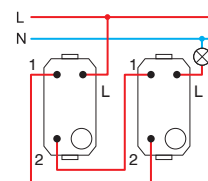

TASTER WECHSEL 16A 250V~ 1M



SM61

- Taster ohne Wippe
- 16A 250V~, Typ SM61
- entspricht EN 60669-1
- Schraubklemmen 1,5-2,5 mm²

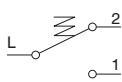

PUSH BUTTON 2WAY 16A 250V~ 1M

- push button without button
- 16A 250V~, type SM61
- in accordance with EN 60669-1
- screw contacts 1.5-2.5mm²

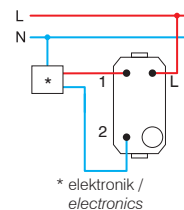

SCHALTER KREUZ 16AX 250V~ 1M



SM70

- Schalter ohne Wippe
- 16AX 250V~, Typ SM70
- entspricht EN 60669-1
- Schraubklemmen 1,5-2,5 mm²

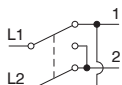

SWITCH INTERMEDIATE 16AX 250V~ 1M

- switch without button
- 16AX 250V~, type SM70
- in accordance with EN 60669-1
- screw contacts 1.5-2.5mm²

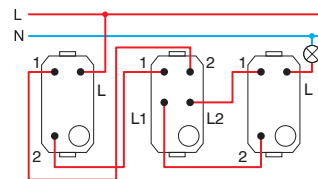

1M = 22,5 x 45
2M = 45 x 45

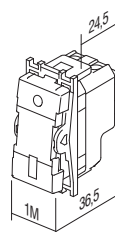
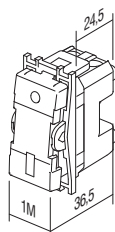



□ PW Weiß-glänzend
polar white



■ SB Schwarz-matt
soft touch black



□ ES Silber-matt
elox silver



□ IW Beige-glänzend
ivory white

SCHALTER 1-POLIG 16AX 250V~ 1M



- SM10PW
- SM10SB
- SM10ES
- SM10IW

- 16AX 250V~, Typ SM10
- entspricht EN 60669-1
- Schraubklemmen 1,5-2,5 mm²
- Wippe auswechselbar

SWITCH 1WAY 16AX 250V~ 1M
- 16AX 250V~, type SM10
- in accordance with EN 60669-1
- screw contacts 1.5-2.5 mm²
- replaceable button



SCHALTER 1-POLIG 16AX 250V~ 1M __ IN



- SM10PWIN
- SM10SBIN
- SM10ESIN
- SM10IWIN

- IN Indikator
- 16AX 250V~, Typ SM10
- entspricht EN 60669-1
- Schraubklemmen 1,5-2,5 mm²
- ohne Glühlampe
- Wippe auswechselbar

SWITCH 1WAY 16AX 250V~ 1M __ IN
- IN indicator
- 16AX 250V~, type SM10
- in accordance with EN 60669-1
- screw contacts 1.5-2.5 mm²
- lamp is not included
- replaceable button



TASTER 1-POLIG 16A 250V~ 1M



- SM11PW
- SM11SB
- SM11ES
- SM11IW

- 16A 250V~, Typ SM11
- entspricht EN 60669-1
- Schraubklemmen 1,5-2,5 mm²
- Wippe auswechselbar

PUSH BUTTON 1WAY 16A 250V~ 1M
- 16A 250V~, type SM11
- in accordance with EN 60669-1
- screw contacts 1.5-2.5 mm²
- replaceable button



TASTER 1-POLIG 16A 250V~ 1M __ IN 01



- SM11PWIN01
- SM11SBIN01
- SM11ESIN01
- SM11IWIN01

- IN 01 Indikator Klingel
- 16A 250V~, Typ SM11
- entspricht EN 60669-1
- Schraubklemmen 1,5-2,5 mm²
- ohne Glühlampe
- Wippe auswechselbar

PUSH BUTTON 1WAY 16A 250V~ 1M __ IN 01
- IN 01 indicator bell
- 16A 250V~, type SM11
- in accordance with EN 60669-1
- screw contacts 1.5-2.5 mm²
- lamp is not included
- replaceable button



TASTER 1-POLIG 16A 250V~ 1M __ IN 02

- SM11PWIN02 - IN 02 Indikator Licht
- SM11SBIN02 - 16A 250V~, Typ SM11
- SM11ESIN02 - entspricht EN 60669-1
- SM11IWIN02 - Schraubklemmen 1,5-2,5 mm²
- ohne Glühlampe
- Wippe auswechselbar

PUSH BUTTON 1WAY 16A 250V~ 1M __ IN 02

- IN 02 indicator light
- 16A 250V~, type SM11
- in accordance with EN 60669-1
- screw contacts 1.5-2.5 mm²
- lamp is not included
- replaceable button

**SCHALTER 2-POLIG 16AX 250V~ 1M __ NT 03**

- SM20PWNT03 - NT 03 neutral 0-1
- SM20SBNT03 - 16AX 250V~, Typ SM20
- SM20ESNT03 - entspricht EN 60669-1
- SM20IWN03 - Schraubklemmen 1,5-2,5 mm²
- Wippe auswechselbar

SWITCH 2POLE 16AX 250V~ 1M __ NT 03

- NT 03 neutral 0-1
- 16AX 250V~, type SM20
- in accordance with EN 60669-1
- screw contacts 1.5-2.5 mm²
- replaceable button

**SCHALTER 2-POLIG 16AX 250V~ 1M __ IN**

- SM20PWIN - IN Indikator
- SM20SBIN - 16AX 250V~, Typ SM20
- SM20ESIN - entspricht EN 60669-1
- SM20IWIN - Schraubklemmen 1,5-2,5 mm²
- ohne Glühlampe
- Wippe auswechselbar

SWITCH 2POLE 16AX 250V~ 1M __ IN

- IN indicator
- 16AX 250V~, type SM20
- in accordance with EN 60669-1
- screw contacts 1.5-2.5 mm²
- lamp is not included
- replaceable button

**SCHALTER JALOUSIE 1-0-2 16AX 250V~ 1M __ NT 10**

- SM40PWNT10 - NT 10 neutral 1-0-2
- SM40SBNT10 - 16AX 250V~, Typ SM40
- SM40ESNT10 - entspricht EN 60669-1
- SM40IWN10 - Schraubklemmen 1,5-2,5 mm²
- Wippe auswechselbar

SWITCH SHUTTERS 1-0-2 16AX 250V~ 1M __ NT 10

- NT 10 neutral 1-0-2
- 16AX 250V~, type SM40
- in accordance with EN 60669-1
- screw contacts 1.5-2.5mm²
- replaceable button

**TASTER JALOUSIE 1-0-2 16A 250V~ 1M __ NT 10**

- SM41PWNT10 - NT 10 neutral 1-0-2
- SM41SBNT10 - 16A 250V~, Typ SM41
- SM41ESNT10 - entspricht EN 60669-1
- SM41IWN10 - Schraubklemmen 1,5-2,5 mm²
- Wippe auswechselbar

PUSH BUTTON SHUTTERS 1-0-2 16A 250V~ 1M __ NT 10

- NT 10 neutral 1-0-2
- 16A 250V~, type SM41
- in accordance with EN 60669-1
- screw contacts 1.5-2.5mm²
- replaceable button

**SCHALTER WECHSEL 16AX 250V~ 1M**

- SM60PW - 16AX 250V~, Typ SM60
- SM60SB - entspricht EN 60669-1
- SM60ES - Schraubklemmen 1,5-2,5 mm²
- SM60IW - Wippe auswechselbar

SWITCH 2WAY 16AX 250V~ 1M

- 16AX 250V~, type SM60
- in accordance with EN 60669-1
- screw contacts 1.5-2.5 mm²
- replaceable button



TASTER WECHSEL 16A 250V~ 1M



- SM61PW
- SM61SB
- SM61ES
- SM61IW

- 16A 250V~, Typ SM61
- entspricht EN 60669-1
- Schraubklemmen 1,5-2,5 mm²
- Wippe auswechselbar

PUSH BUTTON 2WAY 16A 250V~ 1M

- 16A 250V~, type SM61
- in accordance with EN 60669-1
- screw contacts 1.5-2.5 mm²
- replaceable button



TASTER WECHSEL MIT SCHNUR 16A 250V~ 1M __ CD



- SM62PWCD
- SM62SBCD
- SM62ESCD
- SM62IWCD

- CD Indikator + Schnur
- Schnur mit einer Länge von 1,5m
- 16A 250V~, Typ SM62
- entspricht EN 60669-1
- Schraubklemmen 1,5-2,5 mm²

PUSH BUTTON 2WAY WITH CORD 16A 250V~ 1M __ CD

- CD indicator+cord
- cord lenght 1.5m
- 16A 250V~, type SM62
- in accordance with EN 60669-1
- screw contacts 1.5-2.5 mm²



SCHALTER KREUZ 16AX 250V~ 1M



- SM70PW
- SM70SB
- SM70ES
- SM70IW

- 16AX 250V~, Typ SM70
- entspricht EN 60669-1
- Schraubklemmen 1,5-2,5 mm²
- Wippe auswechselbar

SWITCH INTERMEDIATE 16AX 250V~ 1M

- 16AX 250V~, type SM70
- in accordance with EN 60669-1
- screw contacts 1.5-2.5 mm²
- replaceable button



1M = 22,5 x 45
2M = 45 x 45

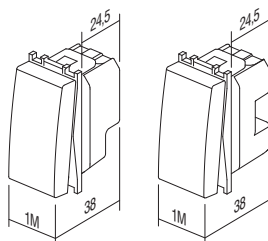

BUTTONS T M

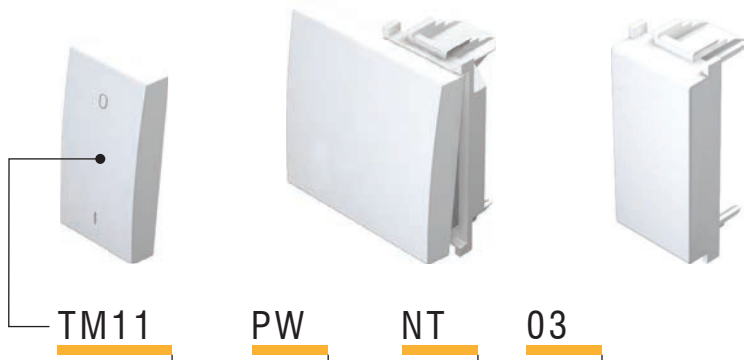

Typ type	Bezeichnung description	Größe size	Farbe colour	Optionsbez. 1 optional data 1	Optionsbez. 2 optional data 2
TM11	WIPPE BUTTON	1M	<input type="checkbox"/> PW Weiß-glänzend polar white <input type="checkbox"/> SB Schwarz-matt soft touch black <input type="checkbox"/> ES Silber-matt elox silver <input type="checkbox"/> IW Beige-glänzend ivory white	NT neutral neutral IN indikator indicator	01 02 03 ...
TM12	WIPPE BUTTON	2M			
TM21	BLLENDE BLANK	1M			
...					

WIPPE 1M



- TM11PW
- TM11SB
- TM11ES
- TM11IW

- Wippe auswechselbar, Breite 1M
- entspricht EN 60669-1
BUTTON 1M
- replaceable button 1M
- in accordance with EN 60669-1



KONTROLLWIPPE 1M



- TM11PWIN
- TM11SBIN
- TM11ESIN
- TM11IWIN

- Wippe auswechselbar, Breite 1M
- entspricht EN 60669-1
BUTTON 1M INDICATOR
- replaceable button 1M
- in accordance with EN 60669-1



WIPPE 2M

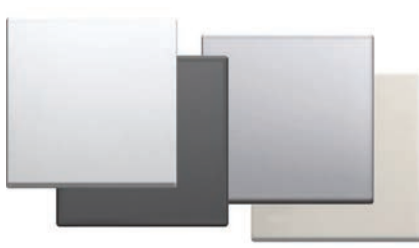

- TM12PW
- TM12SB
- TM12ES
- TM12IW

- Wippe auswechselbar, Breite 2M mit Wippenträger
- für Erweiterung von Schaltern oder Tastern
Breite 1M auf Breite 2M
- entspricht EN 60669-1
BUTTON 2M
- replaceable button 2M with button carrier
- to upgrade switch or push button
from size 1M to size 2M
- in accordance with EN 60669-1



KONTROLLWIPPE 2M

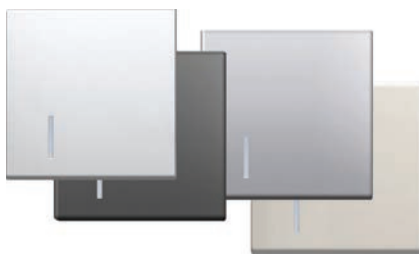

- TM12PWIN
- TM12SBIN
- TM12ESIN
- TM12IWIN

- Wippe auswechselbar, Breite 2M mit Wippenträger
- für Erweiterung von Schaltern oder Tastern
Breite 1M auf Breite 2M
- entspricht EN 60669-1
BUTTON 2M INDICATOR
- replaceable button 2M with button carrier
- to upgrade switch or push button
from size 1M to size 2M
- in accordance with EN 60669-1



WIPPE 2M MIT NAMENSSCHILD

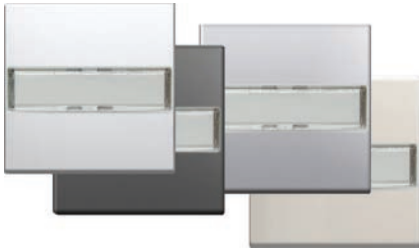

- TM13PWIL
- TM13SBIL
- TM13ESIL
- TM13IWIL

- Wippe auswechselbar, Breite 2M mit Wippenträger
 - für Erweiterung von Schaltern oder Tastern
 - Breite 1M auf Breite 2M
 - entspricht EN 60669-1

BUTTON 2M WITH INSCRIPTION PLATE
 - replaceable button 2M with button carrier
 - to upgrade switch or push button
 from size 1M to size 2M
 - in accordance with EN 60669-1



WIPPE 1M 2-POLIG



- TM15PW
- TM15SB
- TM15ES
- TM15IW

- Wippe auswechselbar, Breite 1M
 - nur in Kombination mit SM20
 - entspricht EN 60669-1

BUTTON 1M 2POLE
 - replaceable button 1M
 - only in combination with mechanism SM20
 - in accordance with EN 60669-1



BLENDE 1M



- TM21PW
- TM21SB
- TM21ES
- TM21IW

- zur Ausfüllung von leeren Stellen
 - entspricht EN 60669-1

BLANK 1M
 - blank modul to fill up empty spaces
 - in accordance with EN 60669-1



BLENDE 2M

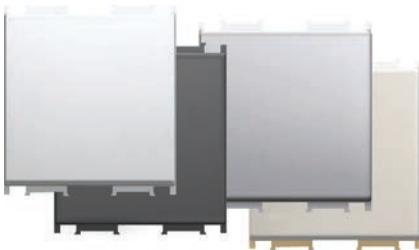

- TM22PW
- TM22SB
- TM22ES
- TM22IW

- zur Ausfüllung von leeren Stellen
 - entspricht EN 60669-1

BLANK 2M
 - blank modul to fill up empty spaces
 - in accordance with EN 60669-1



KABELEINFÜHRUNG 1M

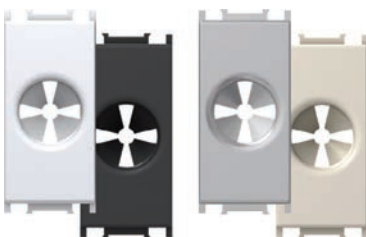

- TM31PW
- TM31SB
- TM31ES
- TM31IW

- Einführung für Kabel
 - entspricht EN 60669-1

CABLE OUTLET 1M
 - outlet for cable
 - in accordance with EN-60669-1



1M = 22,5 x 45
 2M = 45 x 45

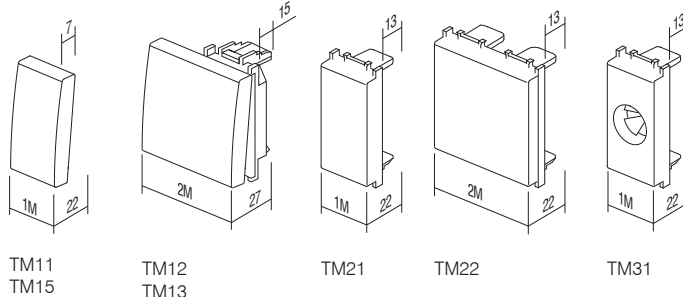

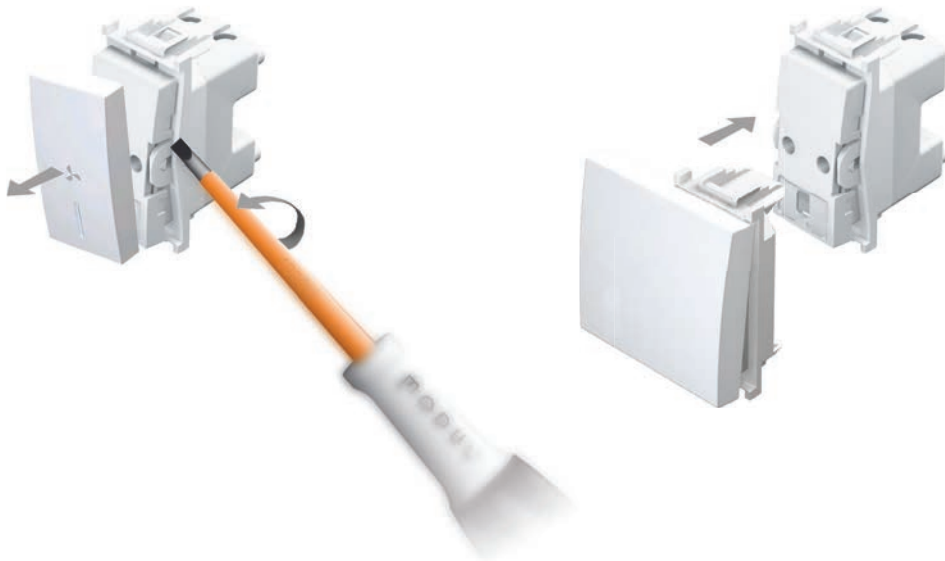

LASERDRUCK AUF WIPPEN

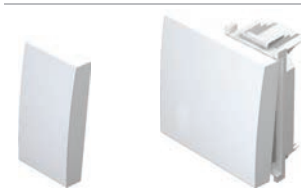

- Laserdruck von beliebigen Symbolen auf gekennzeichnete Stellen
- Standardsymbole auf Lager, andere nach Bestellung

LASER PRINT ON BUTTONS

- laser print of any graphics on marked locations
- standard symbols from stock, other on request

1M

A
B
C

2M

A	D	G
B	E	H
C	F	I

GRAPHIKEN

SYMBOLS

01	02	03	04	05	06	07	08	09	10	11	12	20	21	22	23
24	25	26	27	28	29	30	31	32	33	34	35	36	37	38	39
			alarm	alarm	OFF	ON					AC				
40	41	42	43	44	45	46	47	48							

STANDARDGRAPHIKEN

STANDARD SYMBOLS



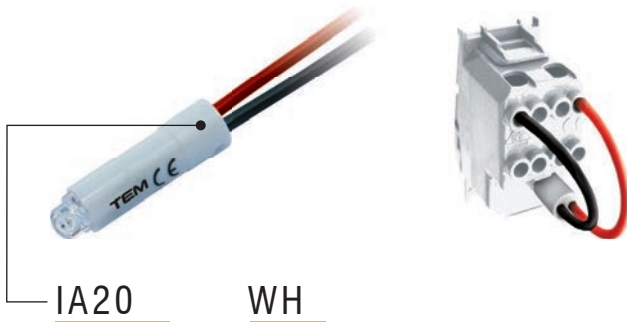

Typ type	Bezeichnung description	Technische daten technical data	Farbe colour
IA10	GLÜHLAMPE NEON LAMP	230V~ 0,34W	<input type="checkbox"/> WH Weiß white
IA20	LED-LAMPE LED LAMP	230V~ 0,40W	<input checked="" type="checkbox"/> BL Blau blue
IA21	LED-LAMPE LED LAMP	24V AC/DC 0,20W	<input checked="" type="checkbox"/> RD Rot red
.	.	.	<input checked="" type="checkbox"/> GR Grün green
.	.	.	<input checked="" type="checkbox"/> OR Orange orange

GLÜHLAMPE 230V~ 0,34 W



IA10OR

- für Kontrollbeleuchtung, Beleuchtung oder ständige Beleuchtung
- in Kombination mit Wippe mit einem Indikator

NEON LAMP 230V~ 0,34W
- for indication, illumination or constant illumination of switch
- in combination with button with indicator

LED-LAMPE 230V AC/DC 0,40 W



- IA20WH
- IA20GR
- IA20RD
- IA20BL

- für Kontrollbeleuchtung, Beleuchtung oder ständige Beleuchtung
- in Kombination mit Wippe mit einem Indikator

LED LAMP 230V AC/DC 0,40W
- for indication, illumination or constant illumination of switch
- in combination with button with indicator

LED-LAMPE 24V AC/DC 0,20 W



IA21RD

- für Kontrollbeleuchtung, Beleuchtung oder ständige Beleuchtung
- in Kombination mit Wippe mit einem Indikator

LED LAMP 24V AC/DC 0,20W
- for indication, illumination or constant illumination of switch
- in combination with button with indicator

LED-LAMPE 12V AC/DC 0,10 W



IA22RD

- für Kontrollbeleuchtung, Beleuchtung oder ständige Beleuchtung
- in Kombination mit Wippe mit einem Indikator

LED LAMP 12V AC/DC 0,10W
- for indication, illumination or constant illumination of switch
- in combination with button with indicator

I L L U M I N A T I O N I A

Kontrollbeleuchtung/ ★
Indication

Beleuchtung/
Illumination

Ständige Beleuchtung/ ★
Constant illumination

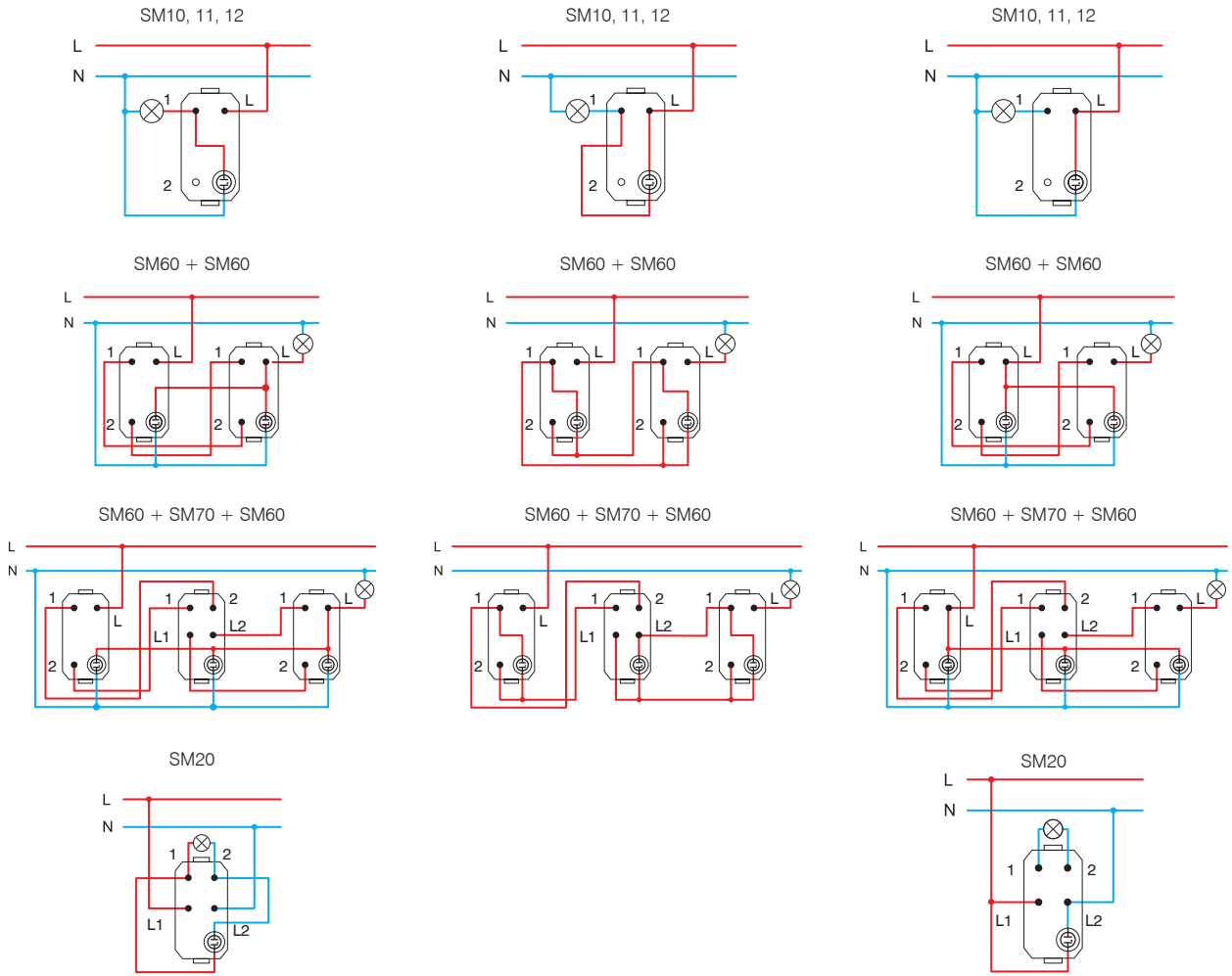

* Schaltung geeignet für Sparlampen (CFL) / wiring schemes for compact fluid lamp (CFL)

1M = 22,5 x 45
2M = 45 x 45

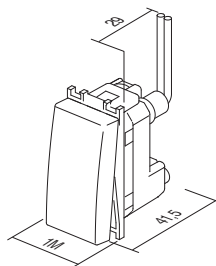



VM11

PT

Typ type	Bezeichnung description	Technische daten technical data	Größe size	Farbe colour																																										
VM10	STECKDOSE SCHUKO+KS SOCKET SCHUKO+KS	2P+E 16A 250V~ 2M		<table border="0"> <tr> <td><input type="checkbox"/> PW</td> <td>Weiß-glänzend <i>polar white</i></td> <td><input type="checkbox"/> PT</td> <td>Weiß+transparent <i>white+transparent</i></td> <td><input type="checkbox"/> PP</td> <td>Weiß+weiß <i>white+white</i></td> </tr> <tr> <td><input type="checkbox"/> SB</td> <td>Schwarz-matt <i>black</i></td> <td><input type="checkbox"/> BT</td> <td>Schwarz+transparent <i>black+transparent</i></td> <td><input type="checkbox"/> BB</td> <td>Schwarz+schwarz <i>black+black</i></td> </tr> <tr> <td><input type="checkbox"/> ES</td> <td>Silber-matt <i>elox silver</i></td> <td><input type="checkbox"/> ST</td> <td>Silber+transparent <i>silver+transparent</i></td> <td><input type="checkbox"/> SS</td> <td>Silber+silber <i>silver+silver</i></td> </tr> <tr> <td><input type="checkbox"/> IW</td> <td>Beige-glänzend <i>ivory white</i></td> <td><input type="checkbox"/> IT</td> <td>Beige+transparent <i>ivory+transparent</i></td> <td><input type="checkbox"/> II</td> <td>Beige+beige <i>ivory+ivory</i></td> </tr> <tr> <td><input type="checkbox"/> RD</td> <td>Rot <i>red</i></td> <td><input type="checkbox"/> RT</td> <td>Rot+transparent <i>red+transparent</i></td> <td><input type="checkbox"/> RR</td> <td>Rot+rot <i>red+red</i></td> </tr> <tr> <td><input type="checkbox"/> GR</td> <td>Grün <i>green</i></td> <td><input type="checkbox"/> GT</td> <td>Grün+transparent <i>green+transparent</i></td> <td><input type="checkbox"/> GG</td> <td>Grün+grün <i>green+green</i></td> </tr> <tr> <td><input type="checkbox"/> OR</td> <td>Orange <i>orange</i></td> <td><input type="checkbox"/> OT</td> <td>Orange+transparent <i>orange+transparent</i></td> <td><input type="checkbox"/> OO</td> <td>Orange+orange <i>orange+orange</i></td> </tr> </table>	<input type="checkbox"/> PW	Weiß-glänzend <i>polar white</i>	<input type="checkbox"/> PT	Weiß+transparent <i>white+transparent</i>	<input type="checkbox"/> PP	Weiß+weiß <i>white+white</i>	<input type="checkbox"/> SB	Schwarz-matt <i>black</i>	<input type="checkbox"/> BT	Schwarz+transparent <i>black+transparent</i>	<input type="checkbox"/> BB	Schwarz+schwarz <i>black+black</i>	<input type="checkbox"/> ES	Silber-matt <i>elox silver</i>	<input type="checkbox"/> ST	Silber+transparent <i>silver+transparent</i>	<input type="checkbox"/> SS	Silber+silber <i>silver+silver</i>	<input type="checkbox"/> IW	Beige-glänzend <i>ivory white</i>	<input type="checkbox"/> IT	Beige+transparent <i>ivory+transparent</i>	<input type="checkbox"/> II	Beige+beige <i>ivory+ivory</i>	<input type="checkbox"/> RD	Rot <i>red</i>	<input type="checkbox"/> RT	Rot+transparent <i>red+transparent</i>	<input type="checkbox"/> RR	Rot+rot <i>red+red</i>	<input type="checkbox"/> GR	Grün <i>green</i>	<input type="checkbox"/> GT	Grün+transparent <i>green+transparent</i>	<input type="checkbox"/> GG	Grün+grün <i>green+green</i>	<input type="checkbox"/> OR	Orange <i>orange</i>	<input type="checkbox"/> OT	Orange+transparent <i>orange+transparent</i>	<input type="checkbox"/> OO	Orange+orange <i>orange+orange</i>
<input type="checkbox"/> PW	Weiß-glänzend <i>polar white</i>	<input type="checkbox"/> PT	Weiß+transparent <i>white+transparent</i>	<input type="checkbox"/> PP	Weiß+weiß <i>white+white</i>																																									
<input type="checkbox"/> SB	Schwarz-matt <i>black</i>	<input type="checkbox"/> BT	Schwarz+transparent <i>black+transparent</i>	<input type="checkbox"/> BB	Schwarz+schwarz <i>black+black</i>																																									
<input type="checkbox"/> ES	Silber-matt <i>elox silver</i>	<input type="checkbox"/> ST	Silber+transparent <i>silver+transparent</i>	<input type="checkbox"/> SS	Silber+silber <i>silver+silver</i>																																									
<input type="checkbox"/> IW	Beige-glänzend <i>ivory white</i>	<input type="checkbox"/> IT	Beige+transparent <i>ivory+transparent</i>	<input type="checkbox"/> II	Beige+beige <i>ivory+ivory</i>																																									
<input type="checkbox"/> RD	Rot <i>red</i>	<input type="checkbox"/> RT	Rot+transparent <i>red+transparent</i>	<input type="checkbox"/> RR	Rot+rot <i>red+red</i>																																									
<input type="checkbox"/> GR	Grün <i>green</i>	<input type="checkbox"/> GT	Grün+transparent <i>green+transparent</i>	<input type="checkbox"/> GG	Grün+grün <i>green+green</i>																																									
<input type="checkbox"/> OR	Orange <i>orange</i>	<input type="checkbox"/> OT	Orange+transparent <i>orange+transparent</i>	<input type="checkbox"/> OO	Orange+orange <i>orange+orange</i>																																									
VM11	STECKDOSE SCHUKO+KS+ KLAPPDECKEL SOCKET SCHUKO+KS+COVER	2P+E 16A 250V~ 2M																																												
VM20	STECKDOSE EURO+KS SOCKET EURO+KS	2P 10A 250V~ 1M																																												



STECKDOSE SCHUKO+KS 2P+E 16A 250V~ 2M

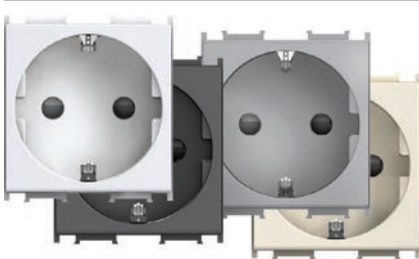

- VM10PW
- VM10SB
- VM10ES
- VM10IW

- Steckdose mit Schutzkontakt
- 16A 250V~, Typ VM10
- entspricht IEC 60884-1, CEE7
- Schraubklemmen 1,5-2,5 mm²
- gegen Berührung stromführender Teile geschützt

- SOCKET SCHUKO+KS 2P+E 16A 250V~ 2M
- 2P+E schuko
 - 16A 250V~, type VM10
 - in accordance with IEC 60884-1, CEE7
 - screw contacts 1.5-2.5 mm²
 - KS built-in child protection - shuttered live contacts



STECKDOSE SCHUKO+KS 2P+E 16A 250V~ 2M

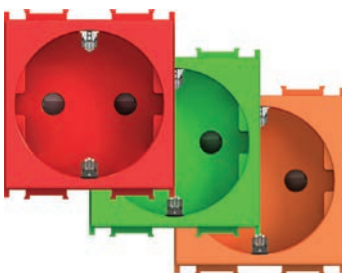

- VM10RD
- VM10GR
- VM10OR

- Steckdose mit Schutzkontakt
- 16A 250V~, Typ VM10
- entspricht IEC 60884-1, CEE7
- Schraubklemmen 1,5-2,5 mm²
- gegen Berührung stromführender Teile geschützt

- SOCKET SCHUKO+KS 2P+E 16A 250V~ 2M
- 2P+E schuko socket
 - 16A 250V~, type VM10
 - in accordance with IEC 60884-1, CEE7
 - screw contacts 1.5-2.5 mm²
 - KS built-in child protection - shuttered live contacts



STECKDOSE SCHUKO+KS+KLAPPDECKEL 2P+E 16A 250V~ 2M

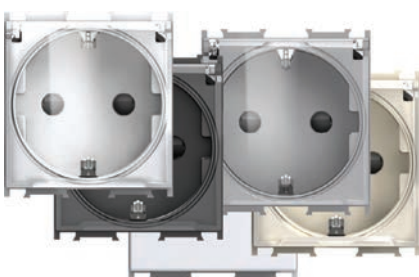

- VM11PT
- VM11BT
- VM11ST
- VM11IT
- VM11PP

- Steckdose mit Schutzkontakt mit Klappdeckel
- 16A 250V~, Typ VM11
- entspricht IEC 60884-1, CEE7
- Schraubklemmen 1,5-2,5 mm²
- gegen Berührung stromführender Teile geschützt

- SOCKET SCHUKO+KS+COVER
2P+E 16A 250V~ 2M
- 2P+E schuko+cover
 - 16A 250V~, type VM11
 - in accordance with IEC 60884-1, CEE7
 - screw contacts 1.5-2.5 mm²
 - KS built-in child protection - shuttered live contacts



S O C K E T S V M

STECKDOSE EURO+KS 2P 10A 250V~ 1M

- VM20PW
- VM20SB
- VM20ES
- VM20IW

- 2P Euro
- 10A 250V~, Typ VM20
- entspricht IEC 60884-1, CEE7
- Schraubklemmen 1,5-2,5 mm²
- gegen Berührung stromführender Teile geschützt

SOCKET EURO+KS 2P 10A 250V~ 1M

- 2P Euro
- 10A 250V~, type VM20
- in accordance with IEC 60884-1, CEE7
- screw contacts 1.5-2.5 mm²
- KS built-in child protection - shuttered live contacts

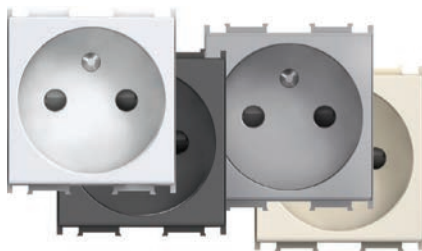
**STECKDOSE FRANZÖSISCH+KS 2P+E 16A 250V~ 2M PW**

- VM40PW
- VM40SB
- VM40ES
- VM40IW

- Steckdose mit Schutzkontakt, französischer Standard
- 16A 250V~, Typ VM40
- entspricht IEC 60884-1, NF C 61-314, CEE7
- Schraubklemmen 1,5-2,5 mm²
- gegen Berührung stromführender Teile geschützt

SOCKET FRENCH+KS 2P+E 16A 250V~ 2M

- 2P+E French
- 16A 250V~, type VM40
- in accordance with IEC 60884-1, NF C 61-314, CEE7
- screw contacts 1.5-2.5 mm²
- KS built-in child protection - shuttered live contacts

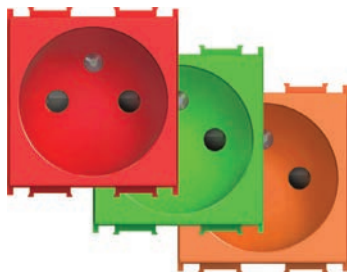
**STECKDOSE FRANZÖSISCH+KS 2P+E 16A 250V~ 2M**

- VM40RD
- VM40GR
- VM40OR

- Steckdose mit Schutzkontakt, französischer Standard
- 16A 250V~, Typ VM40
- entspricht IEC 60884-1, NF C 61-314, CEE7
- Schraubklemmen 1,5-2,5 mm²
- gegen Berührung stromführender Teile geschützt

SOCKET FRENCH+KS 2P+E 16A 250V~ 2M

- 2P+E French
- 16A 250V~, type VM40
- in accordance with IEC 60884-1, NF C 61-314, CEE7
- screw contacts 1.5-2.5 mm²
- KS built-in child protection - shuttered live contacts

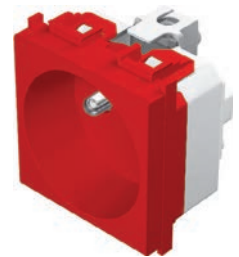
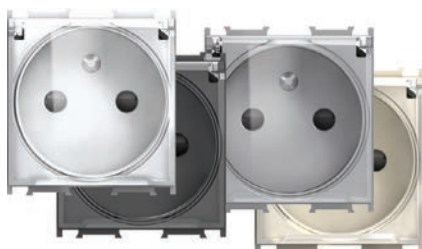
**STECKDOSE FRANZÖSISCH+KS+KLAPPDECKEL 2P+E 16A 250V~ 2M**

- VM41PT
- VM41BT
- VM41ST
- VM41IT

- Steckdose mit Schutzkontakt mit Klappdeckel, französischer Standard
- 16A 250V~, Typ VM41
- entspricht IEC 60884-1, NF C 61-314, CEE7
- Schraubklemmen 1,5-2,5 mm²
- gegen Berührung stromführender Teile geschützt

SOCKET FRENCH+KS+COVER

- 2P+E 16A 250V~ 2M
- 2P+E French+cover
- 16A 250V~, type VM41
- in accordance with IEC 60884-1, NF C 61-314, CEE7
- screw contacts 1.5-2.5 mm²
- KS built-in child protection - shuttered live contacts

**STECKDOSE ITALIENISCH P17/11+KS 2P+E 16A 250V~ 1M**

- VM30PW
- VM30SB
- VM30ES
- VM30IW

- Steckdose mit Schutzkontakt, italienischer Standard P17/11
- 16A 250V~, Typ VM30
- entspricht IEC 60884-1, CEI 23-50
- Schraubklemmen 1,5-2,5 mm²
- gegen Berührung stromführender Teile geschützt

SOCKET ITALIAN P17/11+KS 2P+E 16A 250V~ 1M

- 2P+E Italian P17/11
- 16A 250V~, type VM30
- in accordance with IEC 60884-1, CEI 23-50
- screw contacts 1.5-2.5 mm²
- KS built-in child protection - shuttered live contacts

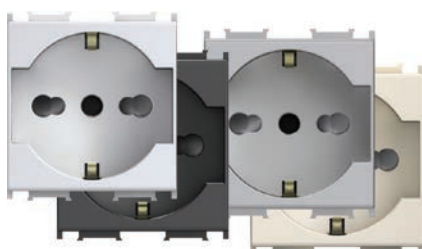
**STECKDOSE SCHUKO/ITA P17/11+KS 2P+E 16A 250V~ 2M**

- VM31PW
- VM31SB
- VM31ES
- VM31IW

- Steckdose mit Schutzkontakt, italienischer Standard P17/11
- 16A 250V~, Typ SM31
- entspricht IEC 60884-1, CEI 23-50
- Schraubklemmen 1,5-2,5 mm²
- gegen Berührung stromführender Teile geschützt

SOCKET SCHUKO/ITA P17/11+KS

- 2P+E 16A 250V~ 2M
- 2P+E schuko/Italian P17/11
- 16A 250V~, type VM31
- in accordance with IEC 60884-1, CEI 23-50
- screw contacts 1.5-2.5 mm²
- KS built-in child protection - shuttered live contacts

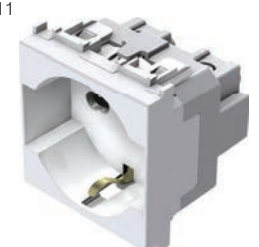

STECKDOSE SCHUKO/ITA P30+KS 2P+E 16A 250V~ 2M



- VM32PW
- VM32SB
- VM32ES
- VM32IW

- Steckdose mit Schutzkontakt, italienischer Standard P30
- 16A 250V~, Typ SM32
- entspricht IEC 60884-1, CEI 23-50
- Schraubklemmen 1,5-2,5 mm²
- gegen Berührung stromführender Teile geschützt



SOCKET SCHUKO/ITA P30+KS

2P+E 16A 250V~ 2M

- 2P+E schuko/italian P30
- 16A 250V~, type VM32
- in accordance with IEC 60884-1, CEI 23-50
- screw contacts 1.5-2.5 mm²
- KS built-in child protection - shuttered live contacts

STECKDOSE ITALIENISCH P11+KS 2P+E 10A 250V~ 1M



- VM33PW
- VM33SB
- VM33ES
- VM33IW

- Steckdose mit Schutzkontakt, italienischer Standard P11
- 10A 250V~, Typ VM33
- entspricht IEC 60884-1, CEI 23-50
- Schraubklemmen 1,5-2,5 mm²
- KS – Kinderschutz gegen Berührung stromführender Teile



SOCKET ITALIAN P11+KS 2P+E 10A 250V~ 1M

- 2P+E Italian P11
- 10A 250V~, type VM33
- in accordance with IEC 60884-1, CEI 23-50
- screw contacts 1.5-2.5 mm²
- KS built-in child protection - shuttered live contacts

STECKDOSE EURO/AMERIKANISCH+KS 2P 16A 250V~ 1M



- VM21PW
- VM21SB
- VM21ES
- VM21IW

- 2P Euro/amerikanischer Standard
- 16A 250V~, Typ SM21
- Schraubklemmen 1,5-2,5 mm²
- gegen Berührung stromführender Teile geschützt



SOCKET EURO/AMERICAN+KS 2P 16A 250V~ 1M

- 2P Euro/American
- 16A 250V~, type VM21
- screw contacts 1.5-2.5 mm²
- KS built-in child protection - shuttered live contacts
- only for countries not members of EU

STECKDOSE BRITISCH BS 546+KS 2P+E 15A 250V~ 2M

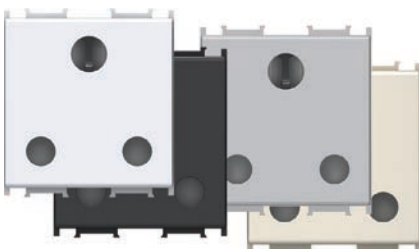

- VM51PW
- VM51SB
- VM51ES
- VM51IW

- Steckdose mit Schutzkontakt, britischer Standard BS 546
- 15A 250V~, Typ VM51
- entspricht BS 546
- Schraubklemmen 1,5-4 mm²
- gegen Berührung stromführender Teile geschützt



SOCKET BRITISH BS 546+KS 2P+E 15A 250V~ 2M

- 2P+E British BS 546
- 15A 250V~, type VM51
- in accordance with BS 546
- screw contacts 1.5-4 mm²
- KS built-in child protection - shuttered live contacts

STECKDOSE BRITISCH BS 1363-2+KS 2P+E 13A 250V~ 2M

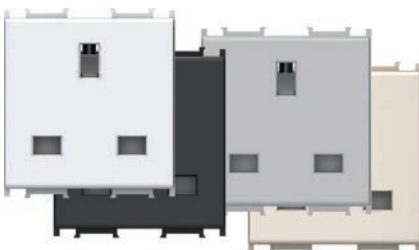

- VM52PW
- VM52SB
- VM52ES
- VM52IW

- Steckdose mit Schutzkontakt, britischer Standard BS 1363-2
- 13A 250V~, Typ VM52
- entspricht BS 1363-2
- Schraubklemmen 1,5-4 mm²
- gegen Berührung stromführender Teile geschützt



SOCKET BRITISH BS 1363-2+KS 2P+E 13A 250V~ 2M

- 2P+E British BS 1363-2
- 13A 250V~, type VM52
- in accordance with BS 1363-2
- screw contacts 1.5-4 mm²
- KS built-in child protection - shuttered live contacts

ÜBERSpannungSSCHUTZ MPE MINI 275V/50Hz



VM80

- Parallelanschluss zur ersten Steckdose in Reihe
- Schutzklasse III
- U_c=275Vac, U_{oc}/I_{sc}=6kV/3kA, U_p<800V
- entspricht IEC 61643-1
- Leiter 1,5 mm², IP20
- Signalton bei Zerstörung



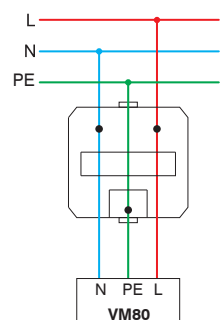

SURGE PROTECTOR MPE MINI 275V/50Hz

- parallel connection with the first socket in the row
- protection class III
- U_c=275Vac, U_{oc}/I_{sc}=6kV/3kA, U_p<800V
- in accordance with IEC 61643-1
- wires 1.5mm², IP20
- sound signal at breakdown



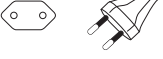

S O C K E T S V M

STECKDOSEN- UND STECKER-ÜBEREINSTIMMUNG
MATCHING SOCKETS AND PLUGS

STECKERART / PLUG STYLE	VM10 VM11	VM20	VM30	VM33	VM31	VM32	VM40 VM41	VM21
Deutsch / German 	•				•	•		
Französisch / French 	•				•	•	•	
Italienisch / Italian S11 			•	•	•	•		
Italienisch / Italian S17 			•		•			
Euro 	•	•	•		•	•	•	•

STECKDOSEN- UND STECKER-ÜBEREINSTIMMUNG
MATCHING SOCKETS AND PLUGS

STECKERART / PLUG STYLE	VM21	VM51	VM52
Amerikanisch / American 	•		
Britisch / British BS 546 		•	
Britisch / British BS 1363-2 			•

1M = 22,5 x 45
2M = 45 x 45

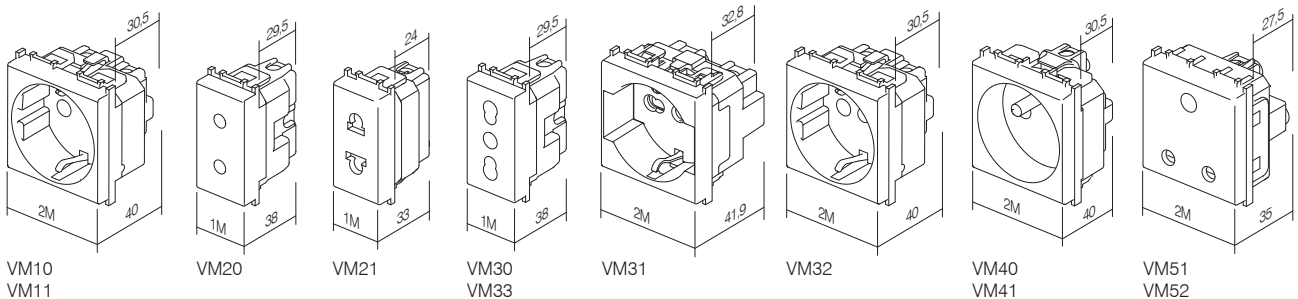



KM10

PW

Typ type	Bezeichnung description	Technische daten technical data	Größe size	Farbe colour
KM10	TV-EINZELDOSE SOCKET TV BASIC	0dB	1M	<input type="checkbox"/> PW Weiß-glänzend polar white
KM11	TV-ENDDOSE SOCKET TV END-LINE	1dB	1M	<input checked="" type="checkbox"/> SB Schwarz-matt soft touch black
KM12	TV-DURCHGANGSDOSE SOCKET TV THROUGHPASS	10dB	1M	<input type="checkbox"/> ES Silber-matt elox silver
.	.	.	.	<input type="checkbox"/> IW Beige-glänzend ivory white

TV-EINZELDOSE 0dB 1M



- KM10PW
- KM10SB
- KM10ES
- KM10IW

- TV-Einzeldose
- Dämpfung 0 dB
- Rückanschluss – F-Standard
SOCKET TV BASIC 0dB 1M
- TV basic
- reduction 0dB
- back connector – F standard



TV-EINZELDOSE 0dB 2M



- KM20PW
- KM20SB
- KM20ES
- KM20IW

- TV-Einzeldose
- Dämpfung 0 dB
- Rückanschluss – F-Standard
SOCKET TV BASIC 0dB 2M
- TV basic
- reduction 0dB
- back connector – F standard



TV-ENDDOSE 1dB 1M



- KM11PW
- KM11SB
- KM11ES
- KM11IW

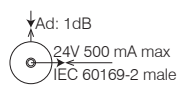

- TV-Enddose
- Übertragungsbandbreite 5÷2400 MHz
- Dämpfung < 1 dB
- entspricht EN 50083-1
- Schraubklemmen
SOCKET TV END-LINE 1dB 1M
- TV end-line
- frequency range 5÷2400 MHz
- reduction < 1 dB
- in accordance with EN 50083-1
- screw contacts



TV-DURCHGANGSDOSE 10dB 1M



- KM12PW
- KM12SB
- KM12ES
- KM12IW

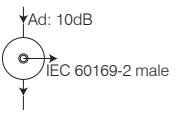

- TV-Durchgangsdose
- Übertragungsbandbreite 5÷2400 MHz
- Dämpfung < 10 dB
- entspricht EN 50083-1
- Schraubklemmen
SOCKET TV THROUGHPASS 10dB 1M
- TV throughpass
- frequency range 5÷2400 MHz
- reduction < 10 dB
- in accordance with EN 50083-1
- screw contacts





SAT-EINZELDOSE 0dB 1M

- KM15PW
- KM15SB
- KM15ES
- KM15IW

- SAT- Einzeldose
- Dämpfung 0 dB
- Rückanschluss – F-Standard

SOCKET SAT BASIC 0dB 1M
- SAT basic
- reduction 0dB
- back connector – F standard



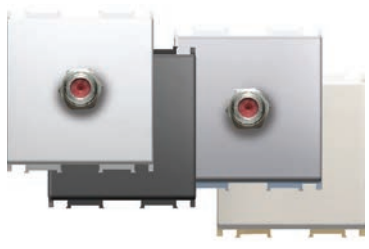



SAT-EINZELDOSE 0dB 2M

- KM24PW
- KM24SB
- KM24ES
- KM24IW

- SAT- Einzeldose
- Dämpfung 0 dB
- Rückanschluss – F-Standard

SOCKET SAT BASIC 0dB 2M
- SAT basic
- reduction 0dB
- back connector – F standard





SAT-ENDDOSE 1dB 1M

- KM16PW
- KM16SB
- KM16ES
- KM16IW

- SAT-Enddose
- Übertragungsbandbreite 5÷2400 MHz
- Dämpfung < 1dB
- entspricht EN 50083-1
- Schraubklemmen

SOCKET SAT END-LINE 1dB 1M
- SAT end-line
- frequency range 5÷2400 MHz
- reduction < 1dB
- in accordance with EN 50083-1
- screw contacts



Ad: 1dB

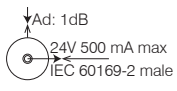





R-EINZELDOSE 0dB 1M

- KM19PW
- KM19SB
- KM19ES
- KM19IW

- R-Einzeldose
- Dämpfung 0 dB
- Rückanschluss – F-Standard

SOCKET R BASIC 0dB 1M
- R basic
- reduction 0dB
- back connector – F standard







R-EINZELDOSE 0dB 2M

- KM29PW
- KM29SB
- KM29ES
- KM29IW

- R-Einzeldose
- Dämpfung 0 dB
- Rückanschluss – F-Standard

SOCKET R BASIC 0dB 2M
- R basic
- reduction 0dB
- back connector – F standard





SAT-TV-ENDDOSE 1dB 2M

- KM25PW
- KM25SB
- KM25ES
- KM25IW

- SAT-TV-Enddose
- Übertragungsbandbreite 5÷2400 MHz
- Dämpfung < 1dB
- entspricht EN 50083-1
- Schraubklemmen

SOCKET SAT-TV END-LINE 1dB 2M
- SAT-TV end-line
- frequency range 5÷2400 MHz
- reduction < 1dB
- in accordance with EN 50083-1
- screw contacts



Ad: 1dB

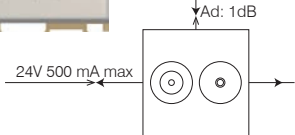

GRUNDSCHALTUNGEN
BASIC CONNECTION SAMPLES

Einzelanschaltung
stand alone connection



KM10
KM20
KM11
KM15
KM24
KM16
KM19
KM29
KM25

Sternschaltung
star connection

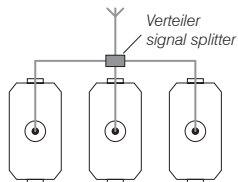

KM10
KM20
KM11
KM15
KM24
KM16
KM19
KM29
KM25

Durchgangsschaltung
throughpass connection

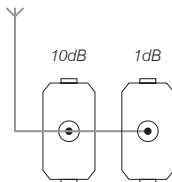

KM12 KM11



- KM22PW
- KM22SB
- KM22ES
- KM22IW

STECKDOSE AUDIO 2xRCA 1M

- Audio-Anschlussdose – 2x RCA
- gelöteter Kabelanschluss hinten

SOCKET AUDIO 2xRCA 1M

- audio 2x RCA
- soldering connection of cable at the back side



- KM23PW
- KM23SB
- KM23ES
- KM23IW

STECKDOSE AUDIO-LAUTSPRECHER 1M

- Audio-Anschlussdose – 2x Ø4 mm
- Kabelanschluss für Lautsprecher, Stecker Ø4 mm oder Gabel-Kabelstecker
- gelöteter Kabelanschluss hinten

SOCKET AUDIO LOUDSPEAKERS 1M

- audio 2x Ø4mm
- to accommodate speaker wire, banana plug Ø4mm or spades
- soldering connection of cable at the back side



1M = 22,5 x 45
2M = 45 x 45

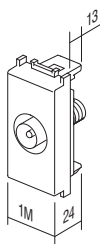

KM10

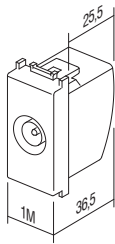

KM11
KM12

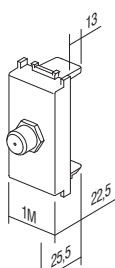

KM15

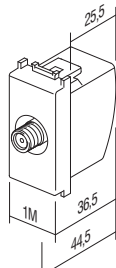

KM16

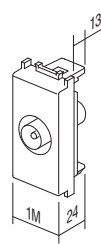

KM19

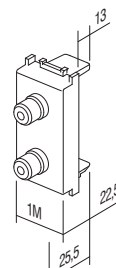

KM22
KM23

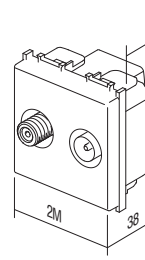

KM25

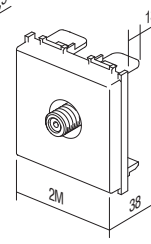

KM20
KM24
KM29

STECKDOSE TEL LT RJ11 6/4 1M



- KM30PW
- KM30SB
- KM30ES
- KM30IW

- TEL LT mit Schraubklemmen
- RJ11 6/4
- entspricht IEC 60603-7
- Schraubklemmen

SOCKET TEL LT RJ11 6/4 1M

- TEL LT screw
- RJ11 6/4
- in accordance with IEC 60603-7
- screw contacts



STECKDOSE TEL BT SEC 6/6 1M



- KM31PW
- KM31SB
- KM31ES
- KM31IW

- TEL BT britischer Standard
- SEC Sekundär 6/6
- entspricht BS 6312
- Schraubklemmen

SOCKET TEL BT SEC 6/6 1M

- TEL BT British standard
- SEC secondary 6/6
- in accordance with BS 6312
- screw contacts



STECKDOSE TEL KS RJ11 6/4 1M



- KM36PW
- KM36SB
- KM36ES
- KM36IW

- KS-keystone-Befestigungsstandard
- RJ11 6/4
- entspricht IEC 60603-7

SOCKET TEL KS RJ11 6/4 1M

- KS keystone fixing standard
- RJ11 6/4
- in accordance with IEC 60603-7



STECKDOSE CAT5e KS RJ45 8/8 1M



- KM37PW
- KM37SB
- KM37ES
- KM37IW

- KS-keystone-Befestigungsstandard
- CAT5e, RJ45 8/8
- entspricht IEC 60603-7

SOCKET CAT5e KS RJ45 8/8 1M

- KS keystone fixing standard
- CAT5e, RJ45 8/8
- in accordance with IEC 60603-7



ADAPTER KS 1M

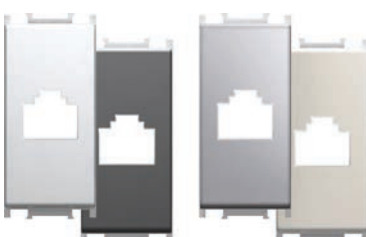

- KM35PW
- KM35SB
- KM35ES
- KM35IW

- KS-keystone-Befestigungsstandard
- AMP, Avaya, Brandrex, FMT, Mfico, Tyco, ...
- ohne Kommunikationsmodul

ADAPTER KS 1M

- KS keystone fixing standard
- AMP, Avaya, Brandrex, FMT, Mfico, Tyco, ...
- communication module not included



ADAPTER KS MIT STAUBSCHUTZ 1M



- KM38PW
- KM38SB
- KM38ES
- KM38IW

- KS-keystone-Befestigungsstandard mit Staubschutz
- AMP, Avaya, Brandrex, FMT, Mfico, Tyco, ...
- ohne Kommunikationsmodul

ADAPTER KS WITH DUST PROTECTION 1M

- KS keystone fixing standard with dust protection
- AMP, Avaya, Brandrex, FMT, Mfico, Tyco, ...
- communication module not included



ADAPTER KS UNIVERSAL 1M



- KM50PW
- KM50SB
- KM50ES
- KM50IW

- KS-keystone-Befestigungsstandard
 - geeignet für HDMI, USB
 - ohne Kommunikationsmodul

ADAPTER KS UNIVERSAL 1M

- KS keystone fixing standard
 - suitable for HDMI, USB
 - communication module not included



ADAPTER PD 1M

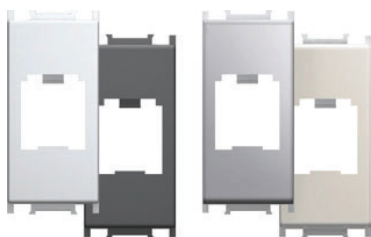

- KM40PW
- KM40SB
- KM40ES
- KM40IW

- PD Panduit Mini-COM-Befestigungsstandard
 - ohne Kommunikationsmodul

ADAPTER PD 1M

- PD Panduit Mini-COM fixing standard
 - communication module not included



ADAPTER PD MIT STAUBSCHUTZ 1M



- KM43PW
- KM43SB
- KM43ES
- KM43IW

- PD Panduit Mini-COM-Befestigungsstandard mit
 Staubschutz
 - ohne Kommunikationsmodul

ADAPTER PD WITH DUST PROTECTION 1M

- PD Panduit Mini-COM fixing standard with
 dust protection
 - communication module not included



ADAPTER R&M 1M



- KM46PW
- KM46SB
- KM46ES
- KM46IW

- R&M-Befestigungsstandard
 - ohne Kommunikationsmodul

ADAPTER R&M 1M

- R&M fixing standard
 - communication module not included



ADAPTER R&M MIT STAUBSCHUTZ 1M



- KM47PW
- KM47SB
- KM47ES
- KM47IW

- R&M-Befestigungsstandard mit Staubschutz
 - ohne Kommunikationsmodul

ADAPTER R&M WITH DUST PROTECTION 1M

- R&M fixing standard with dust protection
 - communication module not included



ADAPTER LK 1M



- KM45PW
- KM45SB
- KM45ES
- KM45IW

- LK LeoniKerpen eLine-/BKS NewLine-Befestigungsstandard
 - ohne Kommunikationsmodul

ADAPTER LK 1M

- LK LeoniKerpen eLine / BKS NewLine fixing standard
 - communication module not included



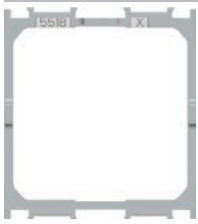

KA26

ADAPTER NEXANS (N423.540N) 2M

- Adapter zur Befestigung der Nexans-Module in der Größe LANmark 45x45mm
- geeignet für Typ N423.540N
- ohne Kommunikationsmodul

ADAPTER NEXANS (N423.540N) 2M

- fixing adapter for Nexans LANmark module 45x45mm
- suitable for type N423.540N
- communication module not included

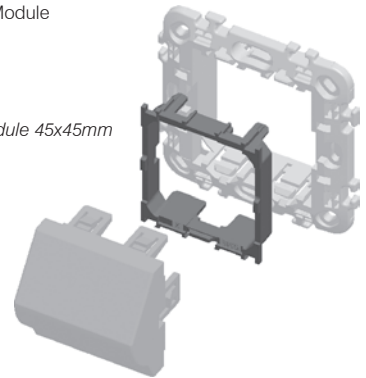

ADAPTER AT&T SYSTIMAX MIT STAUBSCHUTZ 1M



- KM48PW
- KM48SB
- KM48ES
- KM48IW

- AT&T Systimax-Befestigungsstandard mit Staubschutz
- ohne Kommunikationsmodul

ADAPTER AT&T SYSTIMAX WITH DUST PROTECTION 1M

- AT&T Systimax fixing standard with dust protection
- communication module not included



1M = 22,5 x 45
2M = 45 x 45

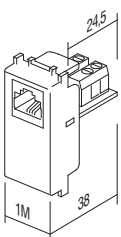

KM30

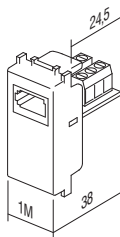

KM31

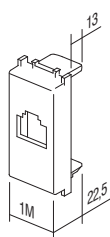

KM35
KM38
KM50
KM48

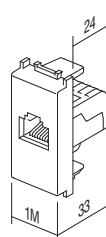

KM36
KM37

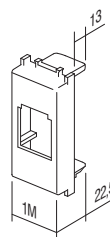

KM40
KM43

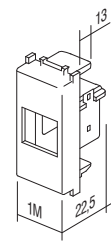

KM45

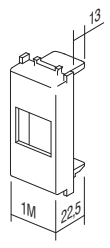

KM46
KM47
KM50

KA10



Typ type	Bezeichnung description	Technische daten technical data
KA10	KONNEKTOR KS CAT3 CONNECTOR KS CAT3	RJ11 6/4
KA11	KONNEKTOR KS CAT5e CONNECTOR KS CAT5e	RJ45 8/8
KA12	KONNEKTOR KS CAT5eS CONNECTOR KS CAT5eS	RJ45 8/8



KONNEKTOR KS CAT3 RJ11 6/4

KA10

- KS keystone-Befestigungsstandard
- CAT3, RJ11 6/4
- entspricht IEC 60603-7

CONNECTOR KS CAT3 RJ11 6/4

- KS keystone fixing standard
- CAT3, RJ11 6/4
- in accordance with IEC 60603-7



KONNEKTOR KS CAT5e RJ45 8/8

KA11

- KS keystone-Befestigungsstandard
- CAT5e, RJ45 8/8
- entspricht IEC 60603-7

CONNECTOR KS CAT5e RJ45 8/8

- KS keystone fixing standard
- CAT5e, RJ45 8/8
- in accordance with IEC 60603-7



KONNEKTOR KS CAT5eS RJ45 8/8

KA12

- KS keystone-Befestigungsstandard
- CAT5eS, RJ45 8/8
- entspricht IEC 60603-7

CONNECTOR KS CAT5eS RJ45 8/8

- KS keystone fixing standard
- CAT5eS, RJ45 8/8
- in accordance with IEC 60603-7



KONNEKTOR KS CAT6 SCH RJ45 8/8

KA15

- KS keystone-Befestigungsstandard
- CAT6 UTP toolless, RJ45 8/8
- entspricht ISO/IEC 11801

CONNECTOR KS CAT6 SCH RJ45 8/8

- KS keystone fixing standard
- CAT6 UTP toolless, RJ45 8/8
- in accordance with ISO/IEC 11801



KONNEKTOR KS CAT6S SCH RJ45 8/8

KA16

- KS keystone-Befestigungsstandard
- CAT6S STP toolless, RJ45 8/8
- entspricht ISO/IEC 11801

CONNECTOR KS CAT6S SCH RJ45 8/8

- KS keystone fixing standard
- CAT6S STP toolless, RJ45 8/8
- in accordance with ISO/IEC 11801



KONNEKTOR KS CAT6a SCH RJ45 8/8

KA17

- KS keystone-Befestigungsstandard
- CAT6a STP toolless, RJ45 8/8
- entspricht ISO/IEC 11801

CONNECTOR KS CAT6a SCH RJ45 8/8

- KS keystone fixing standard
- CAT6a STP toolless, RJ45 8/8
- in accordance with ISO/IEC 11801



KA27

KONNEKTOR KS HDMI

- KS keystone-Befestigungsstandard
- nur in Kombination mit Adapter KM50
- HDMI/HDMI

CONNECTOR KS HDMI

- KS keystone fixing standard
- only in combination with adapter KM50
- HDMI/HDMI



EM31



PW



Typ type	Bezeichnung description	Technische daten technical data	Größe size	Farbe colour
EM10	DIMMER DREH-AUS <i>DIMMER ROTATIVE</i>	R 300W	1M	<input type="checkbox"/> PW Weiß-glänzend <i>polar white</i>
EM11	DIMMER DRUCK-WECHSEL <i>DIMMER ROTATIVE 2WAY</i>	RL 300W	1M	<input type="checkbox"/> SB Schwarz-matt <i>soft touch black</i>
EM21	DIMMER EINBAU <i>DIMMER INBOX</i>	RLC 300W	/	<input type="checkbox"/> ES Silber-matt <i>elox silver</i>
·	·	·	·	<input type="checkbox"/> IW Beige-glänzend <i>ivory white</i>
·	·	·	·	<input type="checkbox"/> BL Blau <i>blue</i>
·	·	·	·	<input type="checkbox"/> RD Rot <i>red</i>
				<input type="checkbox"/> GR Grün <i>green</i>
				<input type="checkbox"/> OR Orange <i>orange</i>
				<input type="checkbox"/> RG Rot/grün <i>red/green</i>

DIMMER DREH-AUS R 300W 1M



- EM10PW
- EM10SB
- EM10ES
- EM10IW

- Dreh-Aus
- Typ RTS34.43 RVR, Belastung R, 40W - 300W
- Versorgung 230V~ 50Hz
- kann nicht mit Wechselschalter verbunden werden
- Verbindung von zwei Dimmern ist nicht gestattet
- entspricht EN 60669-1
- Schraubklemmen 1,5-2,5 mm²
- LED-Kontrollbeleuchtung



DIMMER ROTATIVE R 300W 1M

- rotation control without switch
- type RTS34.43 RVP, load R, 40W - 300W
- supply voltage 230V~ 50Hz
- 2-way switch combination is not possible
- more dimmers combination is not allowed
- in accordance with EN 60669-1
- screw contacts 1.5-2.5mm²
- LED indication

DIMMER DRUCK-WECHSEL RL 300W 1M



- EM11PW
- EM11SB
- EM11ES
- EM11IW

- Druck-Wechsel
- Typ RTS34 DVP, Belastung RL, 40W - 300W
- Versorgung 230V~ 50Hz
- kann mit Wechselschalter verbunden werden
- Verbindung von zwei Dimmern ist nicht gestattet
- Speicherfunktion integriert
- entspricht EN 60669-1
- Schraubklemmen 1,5-2,5 mm²
- LED-Kontrollbeleuchtung



DIMMER ROTATIVE 2WAY RL 300W 1M

- rotation control with 2-way switch
- type RTS34 DVP, load RL, 40W - 300W
- supply voltage 230V~ 50Hz
- 2-way switch combination is possible
- more dimmers combination is not allowed
- light intensity memory
- in accordance with EN 60669-1
- screw contacts 1.5-2.5mm²
- LED indication

DIMMER EINBAU RLC 300W



EM21

- für den Einbau, in Verbindung mit Taster
- Typ RHUN, Belastung RLC, 25W - 300W oder 25VA - 250VA
- Versorgung 230V~ 50Hz
- kann mit mehreren Tastern verbunden werden
- Verbindung von zwei Dimmern ist nicht gestattet
- Speicherfunktion integriert
- Soft-Ein/Aus-Funktion
- entspricht EN 61058-1
- Leiter 1,5 mm²



DIMMER INBOX RLC 300W

- inbox, controlled by external push button
- type RHUN, load RLC, 25W - 300W or 25VA - 250VA
- supply voltage 230V~ 50Hz
- several push-buttons combination is possible
- more dimmers combination is not allowed
- light intensity memory
- soft start / stop function
- in accordance with EN 61058-1
- wires 1.5mm²

DIMMER EINBAU R 500W



EM22

- für den Einbau, in Verbindung mit Taster
- Typ RTL500UN, Belastung R, 40W - 500W
- Versorgung 230V~ 50Hz
- kann mit mehreren Tastern verbunden werden
- Verbindung von zwei Dimmern ist nicht gestattet
- Speicherfunktion integriert
- Soft-Ein/Aus-Funktion
- entspricht EN 61058-1
- Schraubklemmen 1,5-2,5 mm²

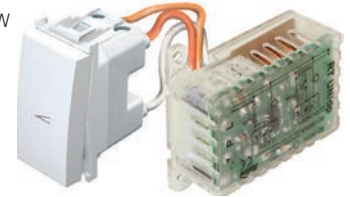

DIMMER INBOX R 500W

- inbox, controlled by external push button
- type RTL500UN, load R, 40W - 500W
- supply voltage 230V~ 50Hz
- several push-buttons combination is possible
- more dimmers combination is not allowed
- light intensity memory
- soft start / stop function
- in accordance with EN 61058-1
- screw contacts 1.5-2.5mm²

EM10 (40÷300W)
EM22 (40÷500W)

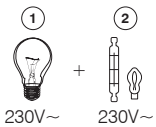

EM11 (40÷300W)

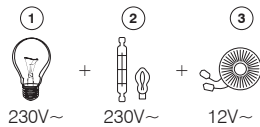

EM21 (25÷300W, 25÷250VA)

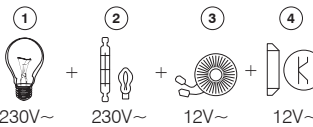

- 1 - Glühlampe / incandescent lamp
- 2 - Halogenlampe / halogen lamp
- 3 - klassischer Transformator / classical transformer
- 4 - elektronischer Transformator / electronic transformer

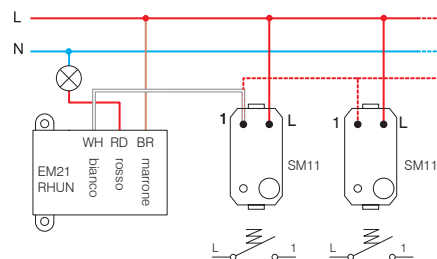
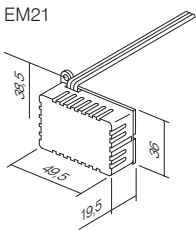
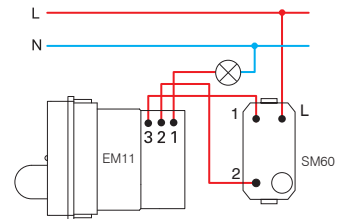
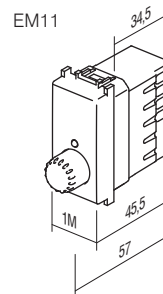
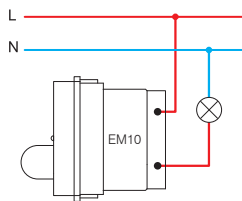
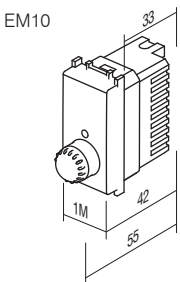

ACHTUNG!

Wenn mehrere Dimmer in einer Box verbunden werden, reduziert sich die maximale Leistung um 10% für jeden Dimmer.

ATTENTION!

If more dimmers are connected in one box reduce maximum common power for 10% for each dimmer.

EM22

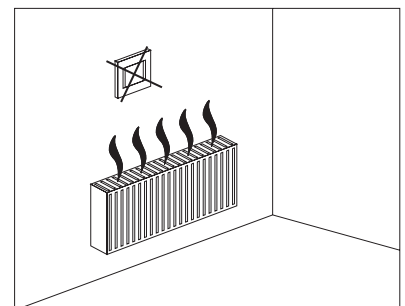
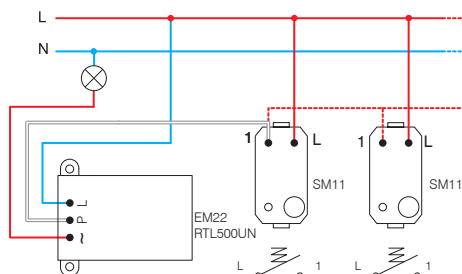
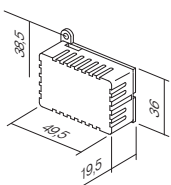

SCHALTER/DIMMER UNIVERSAL RLC 0-300W 2M

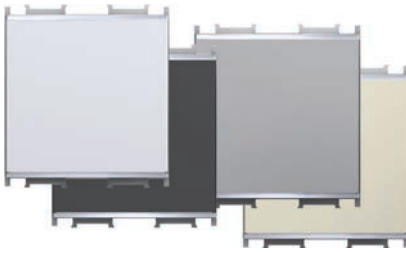

- EM25PW
- EM25SB
- ▒ EM25ES
- EM25IW



- Universeller elektronischer Dimmer zum Ein-/Ausschalten und Verdunkeln von klassischen bzw. der meisten Energiesparlampen (LED und CFL) auch diejenigen, die mit herkömmlichen Dimmern nicht dimmbar sind
- erkennt automatisch den Lampentyp und passt entsprechend die Betriebsart an
- durch die Verdunkelung verringert sich der Stromverbrauch
- die Soft-Ein/Aus-Funktion verlängert die Lebensdauer der Lampen
- Regelung über integrierte Mikroschalter
- Speicherfunktion integriert – speichert den Dimmwert beim Ausschalten
- Schaltung von bis zu fünf (5) zusätzlichen Kontrollschalter EM26 möglich
- kann nicht mit Wechselschalter verbunden werden
- integrierter Kurzschluss-, Überhitzungs- und Überlastungsschutz
- Versorgung 230V~ 50Hz
- hochelegante LED für Beleuchtung, mit Einstellmöglichkeit (farbe und Intensität)
- Wechselmöglichkeit für klassische Schalter – Zweileiterschaltung (40-300W)⁽¹⁾
- durch die Dreileiterschaltung wird die volle Dimmer-Funktion erreicht (0-300W, auch mit LED- und CFL-Lampen, die nicht fürs Dimmen bestimmt sind)⁽²⁾
- entspricht EN 60669-1 und EN 60669-2-1
- Schraubklemmen 1,5 mm² (max. Kraft zum Festziehen der Schrauben 0,4 Nm)

TOUCH EM25 ist ein Mikroprozessor-gesteuerter elektronischer Dimmer. Er ermöglicht das Ein-/Ausschalten und Dimmen von allen dimmbaren und einigen nicht dimmbaren Lampen und Leuchtmitteln. Der integrierte Mikroprozessor erkennt automatisch den Lampentyp und passt entsprechend die Betriebsart an. Die integrierte Speicherfunktion ermöglicht beim Ausschalten des Dimmers die Speicherung der letzten Einstellung. Die Soft-Ein-/Aus-Funktion verlängert die Lebensdauer der Lampen. In der Dimmertaste ist eine hochelegante LED zur Beleuchtung mit verschiedenen Einstellungsmöglichkeiten (Farbe und Intensität) integriert. Schaltung von bis zu 5 zusätzlichen Kontrollschaltern EM26 möglich („Slave“).

TOUCH EM25 is microprocessor controlled electronic light dimmer. It serves as switch and dimmer for dimmable and some of non-dimmable lamps. Integrated microprocessor automatically identifies the type of lamp and adjusts the operating mode. It remembers the level of dimming after switching off due to integrated memory function. Soft-start function extends the lamp service life. In button integrated elegant LED illumination enables many different colours and intensity levels. Optionally one can connect of up to 5 additional control tasters EM26 ("slave").

SWITCH / DIMMER UNIVERSAL RLC 0-300W 2M

- universal electronic dimmer for ON/OFF switching and dimming of classical lamps and most energy saving lamps, both dimmable and non-dimmable
- automatic detection of lamp type and adjustment of operating mode
- reduction of energy consumption
- soft start function extends life of lamps
- controlled by built-in micro switches
- memory function included – memorizes brightness on turn-off
- up to five (5) additional control units EM26 can be connected
- connection with 2-way switch is not possible
- built-in short-circuit, overheating and overload protection
- supply voltage 230V~ 50Hz
- elegant LED illumination, adjustable colour and brightness
- replacement of classical switch is possible at two-wire connection (40-300W)⁽¹⁾
- full functionality is achieved at three-wire connection (0-300W, even non-dimmable LED and CFL lamps)⁽²⁾
- in accordance with EN 60669-1 and EN 60669-2-1
- screw contacts 1,5mm² (max. tightening torque 0.4Nm)

⁽¹⁾Zweileiterschaltung
two-wire connection

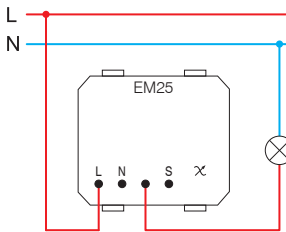

- Die Zweileiterschaltung ermöglicht das Dimmen von dimmbaren Lampen und Leuchtmitteln.

- two-wire connection allows dimming of dimmable lamps

⁽²⁾Dreileiterschaltung
three-wire connection

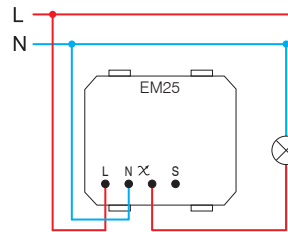

- Die Dreileiterschaltung ermöglicht das Dimmen von dimmbaren Lampen und Leuchtmitteln und einigen nicht dimmbaren LED- und CFL-Lampen.

- three-wire connection allows dimming of dimmable lamps and some of non-dimmable LED and CFL lamps

	1	2	5	6	7
Min.	40 W	40 W	40 VA	40 VA	40 VA
Max.	300 W	300 W	300 VA	100 VA	100 VA
	(F)	(F)	(F)		

- 1 - Glühlampe / incandescent lamp
- 2 - Halogenlampe 220V / halogen lamp 220V
- 4 - elektronischer Transformator / electronic transformer
- 5 - klassischer Transformator / classical transformer

	1	2	4	6	7	8	9
Min.	0 W	0 W	0 VA	0 VA	0 VA	0 VA	0 VA
Max.	300 W	300 W	120 VA	120 VA	120 VA	120 VA	120 VA
	(F)	(F)	(F)			(F)	(F)

- 6 - dimmbare Energiesparlampe CFL / dimmable energy saving CFL lamp
- 7 - dimmbare LED-Lampe / dimmable LED lamp
- 8 - nicht dimmbare Energiesparlampe CFL / non-dimmable energy saving CFL lamp
- 9 - nicht dimmbare LED-Lampe / non-dimmable LED lamp

Anmerkungen / remarks

- (F) Filter EM27 / filter EM27
 - Wir empfehlen die Verwendung eines Filters EM27
- Alle gesteuerten Lampen und Leuchtmittel müssen gleich sein/
- Die Belastungstabelle gilt für Lampen mit Faktor PF > 0,5/

Ein-/Ausschalten und Dimmen der Lichter /
on / off switching and dimming of lamp

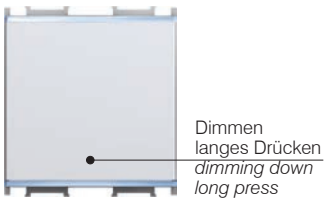
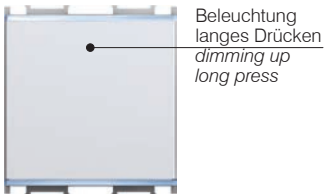
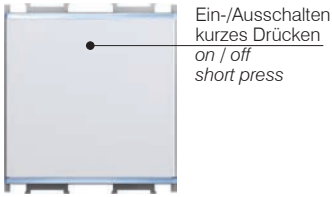

Farbauswahl und Einstellung der LED-Beleuchtungsintensität /
LED colour selection and intensity level adjustment

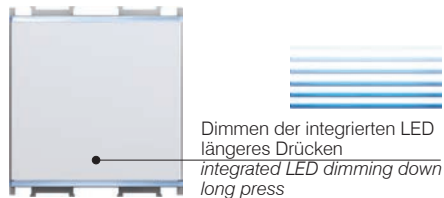
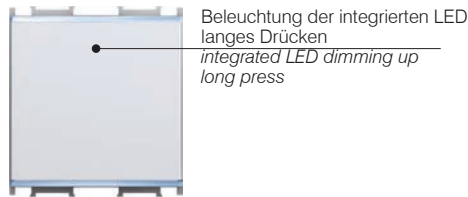
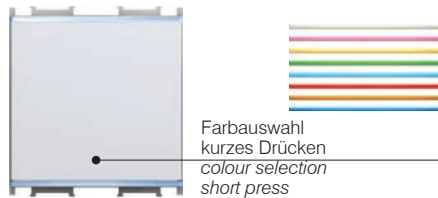

RESET-Funktion / "RESET" function *

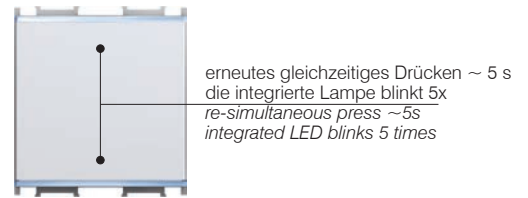

- * - wir empfehlen beim Einbau des Dimmers und beim Wechsel der Lampen und Leuchtmittel diese Funktion durchzuführen
- unbedingt notwendig bei Verwendung von nicht dimmbaren Lampen
- die RESET-Funktion ist bei der Zweileiterschaltung nicht anwendbar
- nur bei EM25 möglich

- it is recommended at dimmer installation and lamp replacement
- mandatory when using non-dimmable lamps
- "RESET" function is not possible when using two-wire connection
- only possible on EM25

Einbauhinweise / installation precautions

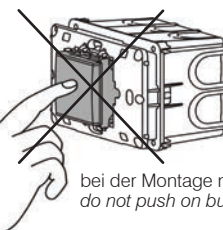
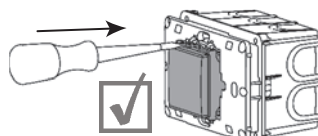
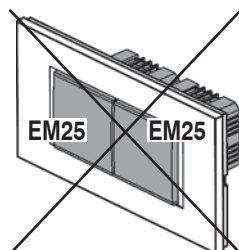
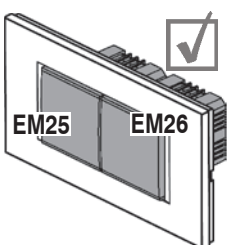

bei der Montage nicht die Taste betätigen /
do not push on button during mounting

KONTROLLTASTER 2M

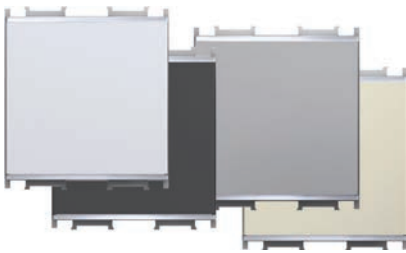

- EM26PW
- EM26SB
- EM26ES
- EM26IW

- in Verbindung mit dem Universaldimmer EM25 ermöglicht dieser Taster die Bedienung der Beleuchtung aus mehreren (bis zu fünf) Standorten mit der gleichen Funktionalität als EM25
- Versorgung 230V~ 50Hz
- entspricht EN 60669-1 und EN 60669-2-1
- Schraubklemmen 1,5 mm² (max. Kraft zum Festziehen der Schrauben 0,4 Nm)

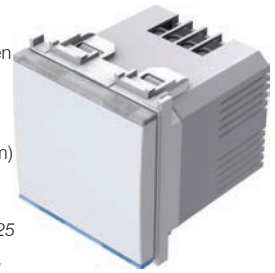

PUSH-BUTTON CONTROL UNIT 2M

- connected to universal dimmer EM25 allows controlling of lamps with same functionality as EM25
- supply voltage 230V~ 50Hz
- in accordance with EN 60669-1 and EN 60669-2-1
- screw contacts 1,5mm² (max. tightening torque 0.4Nm)

⁽¹⁾Zweileiterschaltung
two-wire connection

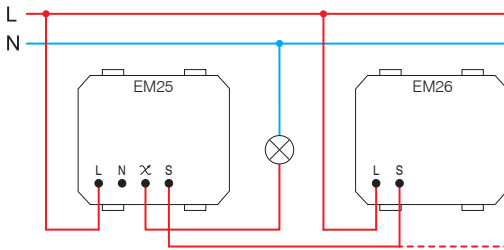

- Die Zweileiterschaltung ermöglicht das Dimmen von dimmbaren Lampen und Leuchtmitteln.
- Im Falle der Zweileiterschaltung wird durch jeden zusätzlichen Kontrolltaster die Minimalbelastung um 25 W vergrößert.

- two-wire connection allows dimming of dimmable lamps
- in a two-wire connection each additional control unit increases the minimum load by 25W

⁽²⁾Dreileiterschaltung
three-wire connection

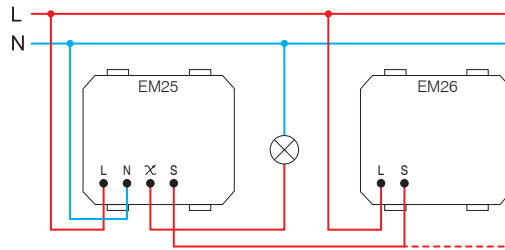

- Die Dreileiterschaltung ermöglicht das Dimmen von dimmbaren Lampen und Leuchtmitteln und einigen nicht dimmbaren LED- und CFL-Lampen.

- three-wire connection allows dimming of dimmable lamps and some of non-dimmable LED and CFL lamps

STÖRUNGSFILTER



- EM27

- Filter für Frequenzstörungen für EM25
- die Abbildung ist symbolisch

FREQUENCY FILTER

- frequency filter for EM25
- image is symbolic

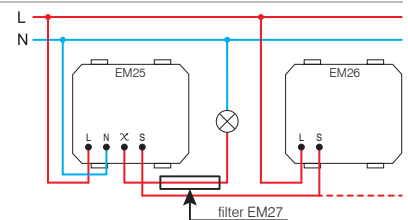

SET SCHALTER/DIMMER UNIVERSAL RLC 0-300W 2M PP OL20

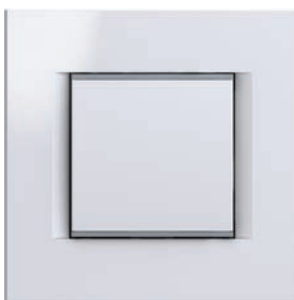

- EM25PPOL20

- Set aus Dimmer EM25, Montageträger 2M und Rahmen LINE 2M PW
- siehe technische Beschreibung EM25

SET SWITCH / DIMMER UNIVERSAL RLC

0-300W 2M PP OL20

- set includes dimmer EM25, mounting frame 2M and cover plate LINE 2M PW
- for technical details see EM25



2M = 45 x 45

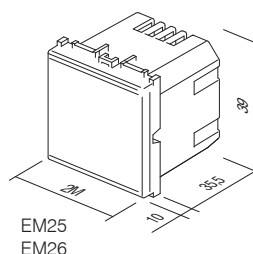

EM25
EM26

IR-SCHALTER 5A 250V~ 1M



- EM30PW
- EM30SB
- EM30ES
- EM30IW

- IR-Schalter
- Versorgung 230V~ ±10% 50Hz
- Relais 5A / 250V~ Ausgang mit hochohmiger Strombegrenzung für den Nulldurchgang
- Schutzart IP40
- Schraubklemmen 0,75 - 2,5 mm²
- Erfassungswinkel bis 110° bei 20°C
- Erfassungsbereich ca. 8 m bei 20°C
- Einstellung der Beleuchtungszeit von ca. 5 s bis 12 min
- Beleuchtungseinstellung von ca. 5 bis 200 Lux
- Betriebstemperatur von 0°C bis +40°C
- nicht geeignet für den Einbau in Dosen mit Tiefe 45 mm und Gehäuse CUBO IP20
- nur für Gebrauch im Innenbereich geeignet



Erfassungsbereich / detection range

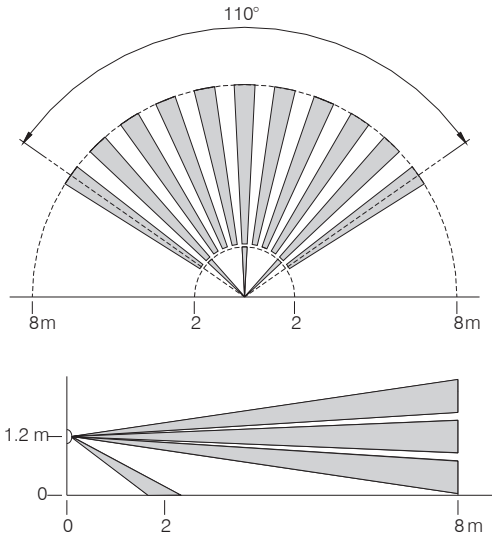

IR SWITCH 5A 250V~ 1M

- IR infrared switch
- supply voltage: 230V~ ±10 % 50Hz
- relay: 5A / 250V~ output for limited current with high resistance for zero crossing
- protection rating: IP40
- cross-section of wires at the contact terminal: 0.75 - 2.5 mm²
- detection angle: up to 110° at 20°C
- detection area: approx. 8 m at 20°C
- adjustability of duration: from approx. 5 s to 12 min
- adjustability of brightness: from approx. 5 to 200 LUX
- operating temperature: from 0°C to +40°C
- not suitable for installation in 45 mm deep boxes and surface mount box CUBO IP20
- only for indoor usage

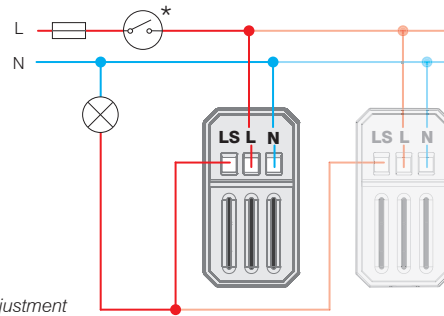

Einstellung der Lichtempfindlichkeit und der Beleuchtungszeit / time and twilight adjustment

Einstellung der Lichtempfindlichkeit twilight sensor threshold adjustment	5 LUX	200 LUX
Einstellung der Beleuchtungszeit time adjustment	~5 s	~12 min

Lasten / loads

	1	2	3	4	5	6	7	8
Min.	1 W	1 W	5A	1 VA	1 W	1 W	1 VA	1 VA
Max.	800 W	800 W		6x20 VA	6x36 W	4x36 W (20µF)	6x23 VA	6x20 VA

1 - Glühlampe / incandescent lamp

2 - Halogenlampe / halogen lamp

3 - Leuchtstoffröhre / resistive heating element

4 - elektronischer Transformator / electronic transformer

5 - Leuchtstoffröhre (Ausführung 1) / fluorescent tube (version 1)

6 - Leuchtstoffröhre (Ausführung 2) / fluorescent tube (version 2)

7 - Energiesparlampe CFL / energy saving CFL lamp

8 - LED-Lampe / LED lamp

Hinweise / attention

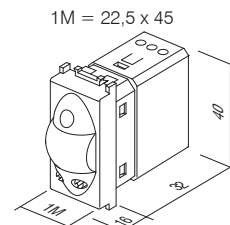
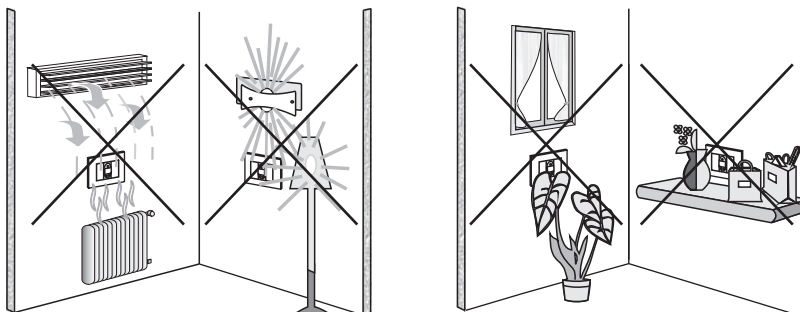

ELEKTRONISCHER THERMOSTAT 6A 250V~ 2M



- EM37PW
- EM37SB
- EM37ES
- EM37IW

- elektronischer Thermostat
- Betriebsart: Heizung/Kühlung/Aus
- Versorgung 230VAC, 50 Hz
- Ausgang: 6(2) A, 230 VAC, Umschaltrelais
- Regelungsbereich: +10°C bis +30 °C
- Hysterese: ±0,5 °C
- Frostschutz (Betriebsart Heizung): +6 °C
- Überhitzungsschutz (Betriebsart Kühlung): +32 °C
- ECO-Funktion zur Temperatursenkung um 3 °C für 6 Stunden in der Betriebsart Heizung und Temperaturerhöhung um 3 °C für 6 Stunden in der Betriebsart Kühlung
- adaptive ECO-Funktion (automatisch jeden Tag zur gleichen Zeit) zur Temperatursenkung um 3 °C für 6 Stunden in der Betriebsart Heizung und Temperaturerhöhung um 3 °C für 6 Stunden in der Betriebsart Kühlung
- Möglichkeit zum externen Einschalten der ECO-Betriebsart über einen separaten Eingang
- LED-Betriebsanzeige
- nicht geeignet für elektrische Fußbodenheizung
- Schraubklemmen max. 2,5 mm²
- entspricht der LV- und EMC-Richtlinie sowie EN60730-1 und EN60730-2-9
- zur korrekten Funktion empfehlen wir den Einbau in eine separate Dose, getrennt von Wärme erzeugenden Geräten
- Anwendungstemperatur: 5 ÷ 35 °C
- Lagerungstemperatur: -20 ÷ 50 °C



Der Thermostat ist zur Regulierung der Raumtemperatur bestimmt. Er ermöglicht zwei Betriebsarten – Heizung und Kühlung. Der Thermostat ist mit zwei Schutzfunktionen ausgestattet – Frostschutz (Betriebsart Heizung) und Überhitzungsschutz (Betriebsart Kühlung) und einer LED-Betriebsanzeige. Die Einstellung erfolgt durch Drehen des Drehknopfes zur Temperatureinstellung und durch Betätigung der kapazitiven Berührungstasten.

The thermostat is intended for regulating temperature in a room. It enables two modes of operation – heating and cooling. It has safety functions installed for protection against freezing (heating mode) and protection against overheating (cooling mode). The operation is indicated via LED lights. Thermostat setup is performed with the help of a rotary button for setting the temperature and with other capacitive touch buttons.

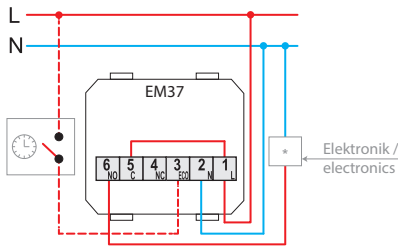

Umlaufpumpe, Brenner (Direktanschluss), thermoelektrischer Antrieb / circulation pump, burner (direct connection) thermoelectric drive

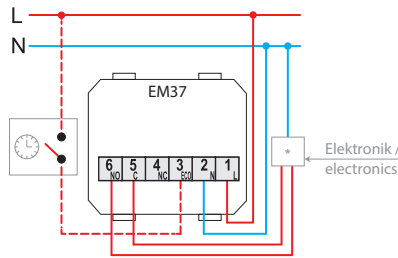

Kessel, Umlaufpumpe, Brenner (Steuereingang T1/T2) / boiler, heat pump, burner (control input T1/T2)

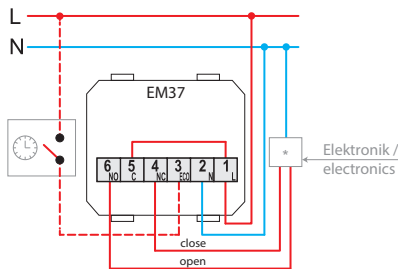

Motorantrieb (begrenzte Verwendung bei Fußbodenheizung) / motor drive (limited use with underfloor heating)

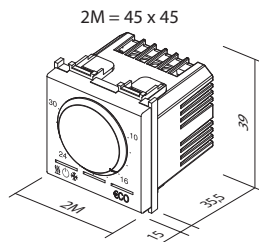

THERMOSTAT BASIC 6A 230 V ~ 2M

- electronic thermostat, basic
- operation mode: heating/cooling/turn off
- power supply: 230 VAC, 50 Hz
- output: 6(2) A, 230 VAC, relay switch
- regulation range: +10°C to +30°C
- hysteresis: ±0.5°C
- anti-freeze protection (heating mode): +6°C
- overheating protection (cooling mode): +32°C
- ECO function for lowering the temperature by 3°C for 6 hours in the heating mode and raising temperature by 3°C for 6 hours in the cooling mode
- adaptive ECO function, automatically every day at the same time lowers the temperature by 3°C for 6 hours in the heating mode and raises temperature by 3°C for 6 hours in the cooling mode
- option to turn on the ECO operating mode by external trigger via a separate input
- LED indication of operation
- not suitable for electrical floor heating
- screw contacts max. 2.5 mm²
- in accordance with the LV Directive, the EMC Directive, standards EN60730-1 and EN60730-2-9
- for correct operation, we recommend installing in an independent single box, separate from devices that generate heat
- operating temperature: 5 ÷ 35°C
- storage temperature: -20 ÷ 50°C

Einstellung der Betriebsart und der Temperatur / function and temperature adjustment

Taste zur Betriebsartauswahl und LED-Zustandsanzeige:
rot: Heizung
blau: Kühlung
leuchtet nicht: ausgeschaltet

function selection button and LED status indicator:
red: heating
blue: air conditioning
no light: switched off

Einstellung der Temperatur / temperature setting

Taste zur Auswahl der ECO-Betriebsart und LED-Indikator der ECO-Betriebsart:
grün: ECO-Betriebsart ein
orange: adaptive ECO-Betriebsart ein
leuchtet nicht: Tagesablauf

“ECO” function selection button and LED “ECO” status indicator
green: ECO energy saving ON
orange: adaptive ECO mode activated
no light: day mode

LED-Indikator des Ausgangsrelais:
weiß: Ausgangsrelais ein
leuchtet nicht: Ausgangsrelais aus

LED output relay state indicator
white: relay ON
no light: relay OFF

Hinweise / attention

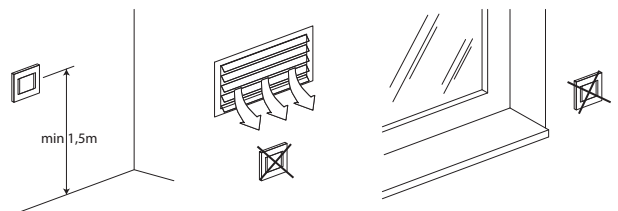



- EM40PW
- EM40SB
- ▒ EM40ES
- EM40IW

ENERGIESPAR-KARTENSCHALTER 3A 250V~ 3M

- elektronischer Schalter aktiviert durch beliebige Standard-ISO-Karte
- Versorgung 230V~ 50Hz
- Ausgangsrelais 3A 250V~ für einen externen Lastschalter*
- Ausschaltungsverzögerung 15-20 s
- entspricht EN 61000-1
- ohne ISO-Karte
- nicht zur Zutrittskontrolle bestimmt



ENERGY SAVER BADGE SWITCH 3A 250V~ 3M

- badge switch basic, any ISO card
- supply voltage 230V~ 50Hz
- output 3A 250V~ for switching contactor *
- switch off delay 15-20s
- in accordance with EN 61000-6-1
- card is not included
- not for access control

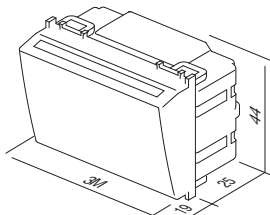

3M = 67,5 x 45

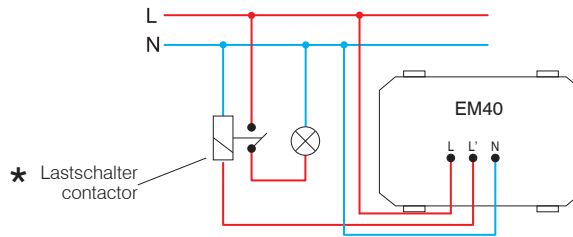

* Lastschalter contactor

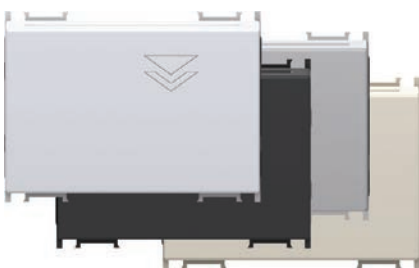

- EM41PW
- EM41SB
- ▒ EM41ES
- EM41IW

ENERGIESPAR-KARTENSCHALTER BARCODE 3M

- elektronischer Schalter aktiviert durch eine ISO-Karte mit Barcode EM47
- Versorgung 5V von der Relaiseinheit EM48
- Ausgang: Verbindung zur Relaiseinheit EM48
- Ausschaltungsverzögerung 15-20 s
- entspricht EN 61000-1
- ohne EM47-Karte
- nicht zur Zutrittskontrolle bestimmt



ENERGY SAVER BADGE SWITCH BAR CODE 3M

- badge electronic switch for ISO card with BAR code EM47
- supply 5V from relay unit EM48
- output to be connected to relay output unit EM48
- switch off delay 15-20s
- in accordance with EN 61000-6-1
- card EM47 is not included
- not for access control



- EM43PW
- EM43SB
- ▒ EM43ES
- EM43IW

ENERGIESPAR-KARTENSCHALTER RF HF 13,56MHz 3M

- elektronischer Schalter aktiviert durch eine RFID-ISO-Karte
- RF-LF-Trägerfrequenz 13,56MHz
- Versorgung 5V von der Relaiseinheit EM48
- Ausgang: Verbindung zur Relaiseinheit EM48
- Ausschaltungsverzögerung 15-20 s
- entspricht EN 61000-1
- ohne RFID-Karte
- nicht zur Zutrittskontrolle bestimmt



ENERGY SAVER BADGE SWITCH RF HF 13,56MHz 3M

- badge electronic switch for RFID ISO card
- RF HF carrier frequency 13,56MHz
- supply 5V from relay unit EM48
- output to be connected to relay output unit EM48
- switch off delay 15-20s
- in accordance with EN 61000-6-1
- RFID card is not included
- not for access control

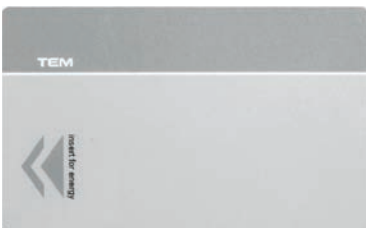

EM47

ISO-KARTE BARCODE

- ISO-Karte mit Barcode
- für Anwendung mit Kartenschalter EM41
- gröÙe: 85x54 mm

BADGE ISO BAR CODE

- ISO card with bar code
- for combination with badge switch EM41
- size: 85x54 mm



EM48

RELAISEINHEIT FÜR KARTENSCHALTER 2x16A 250V~

- Relaiseneinheit für Kartenschalter EM41, EM43
- Versorgung 230V~ 50Hz
- Ausgangsrelais L1 16A 250V~ Grundversorgung
- Ausgangsrelais L2 16A 250V~ HVAC-Versorgung
- M1-, M2-Eingang für Magnetschalter zur Ausschaltung der HVAC bei geöffnetem Fenster bzw. Balkontür
- entspricht EN 61000-1
- Montage auf eine DIN-Leiste 35mm, 4MU



ENERGY SAVER CONTROL UNIT 2x16A 250V~

- relay unit for badge switches EM41, EM43
- supply voltage 230V~ 50Hz
- output relay L1 16A 250V~ main supply
- output relay L2 16A 250V~ HVAC supply
- M1, M2 input for magnetic switch to control HVAC when window or balcony door are opened
- in accordance with EN 61000-6-1
- mounting on DIN rail 35mm, 4MU

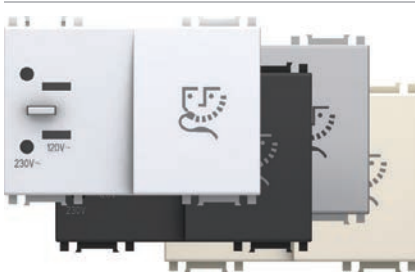
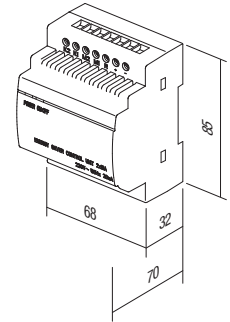
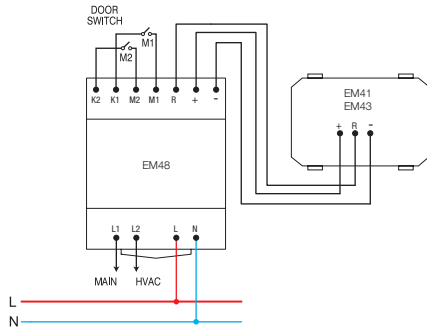

- EM60PW
- EM60SB
- EM60ES
- EM60W

RASIERSTECKDOSE 230V~/125V~ 3M

- Einsatz für Rasierer mit Transformator 20VA
- Eingang: 230V~ 50-60Hz
- Ausgang: 230V~ für 2P 2.5A-Eurostecker oder 125V~ für 2P 15A amerikanischen Stecker
- Schutzklasse II
- entspricht EN 61558-2-5



SOCKET SHAVER 230V~/125V~ 3M

- shaver supply unit with isolating transformer 20VA
- supply: 230V~ 50-60Hz
- output: 230V~ for 2P 2.5A Europlug or 125V~ for 2P 15A American plug
- Class II
- in accordance with EN 61558-2-5

3M = 67,5 x 45

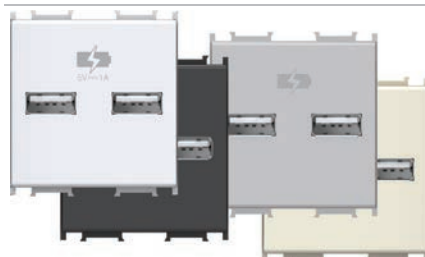
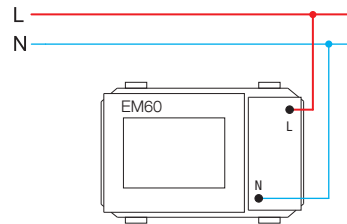
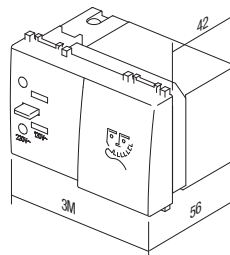

- EM65PW
- EM65SB
- EM65ES
- EM65W

LADEGERÄT USB 5V 1A 2M

- zum Laden der elektronischen Geräte über einen Standard-USB-Anschluss (kompatibel mit Apple-Geräten)
- zum gleichzeitigen Laden von zwei Geräten
- Versorgung 230V~ 50Hz
- Verbrauch in Bereitstellung 50 mW bei 230V~
- Ausgangsspannung 5 VDC (±5%) SELV
- Schwankungen der Ausgangsspannung 150 mV
- nominaler Ausgangsstrom 1A (1 x 1000 mA oder 2 x 500 mA) (±10%)
- Nutzleistung mehr als 67%
- Schutzart IP20, nur für Gebrauch im Innenbereich geeignet
- Schraubklemmen max. 2,5 mm²
- entspricht EN 60950-1 und der EMC-Richtlinie
- Das Ladegerät muss mit einem geeigneten externen Schutzschalter geschützt werden.



2M = 45 x 45

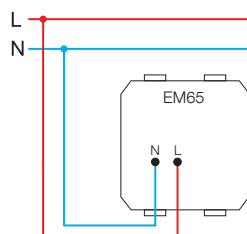
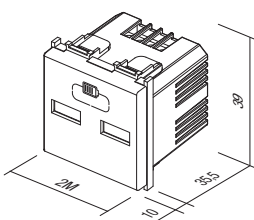

POWER SUPPLY UNIT USB 5V 1A 2M

- for charging of electronic devices via a standard USB port (also compatible with Apple devices)
- enables charging of two devices simultaneously
- power supply: 230V~ 50Hz
- stand-by power consumption: 50 mW at 230V~
- nominal output voltage: 5 VDC (±5%) SELV
- output ripple voltage: 150 mV
- nominal output current: 1 A (1 x 1.000 mA or 2 x 500 mA) (±10%)
- efficiency: greater than 67%
- IP protection class: IP20, indoor use only
- screw contacts: max. 2,5 mm²
- in accordance with EN 60950-1 and EMC directive
- an appropriate external disconnect device needs to be considered as part of installation



EM55

LED-NOTLEUCHTE 250V~ 1,5W, NiMh 6h 7M

- LED-Notleuchte
- Versorgung 230V~ 50Hz 3x0,5W
- LED-Lampen E10, auswechselbar
- NiMh-Akku 1150 mAh, auswechselbar
- 6h-Autonomie, Ladezeit 4 h
- Schutzklasse II
- entspricht EN 60598-1, EN 60598-2-2, EN 60598-2-22
- Helligkeit 76lx / 0,9 m²



LED EMERGENCY LIGHT 250V~ 1.5W, Ni-Mh 6h 7M

- emergency LED lamp
- supply voltage 230V~ 50Hz 3x0.5W LED lamps E10, replaceable
- NiMh accumulator 1150 mAh, replaceable
- autonomy 6h, charging 4h
- Class II
- in accordance with EN 60598-1, EN 60598-2-2, EN 60598-2-22
- illumination 76lx / 0,9m²

7M = 151,5 x 45

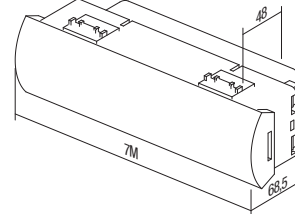
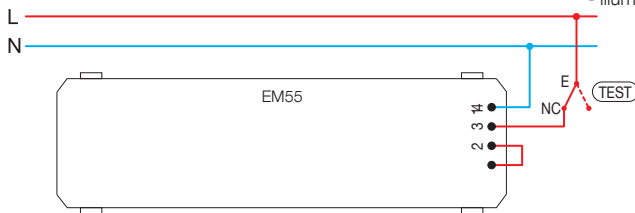

LED-LAMPE EINFARBIG 250V~ 0,8W 2M

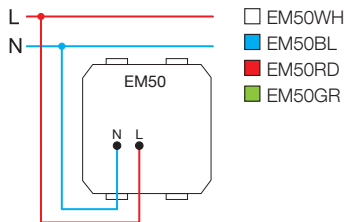

- EM50WH
- EM50BL
- EM50RD
- EM50GR

- LED-Lampe für Beleuchtung von Treppen und Gängen
- Versorgung 230V~ 50Hz 0,8W
- Schutzklasse II
- entspricht EN 60598-1
- auch als Lenk- bzw. Signallampe verwendbar, Laserdruck-Möglichkeit von beliebigen Symbolen

LED LAMP MONOCOLOUR 250V~ 0,8W 2M

- step marker LED lamp
- supply voltage 230V~ 50Hz 0,8W
- Class II
- in accordance with EN 60598-1
- optional usage for directional or signal illumination with customized laser printing on diffuser



LED-LAMPE ZWEIFARBIG 250V~ 2x0,4W 2M

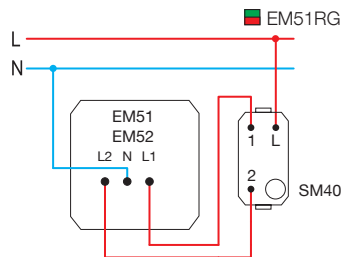

EM51RG

- 2-farbige LED-Signallampe (rot/grün)
- Versorgung 230V~ 50Hz 2x0,4W
- Schutzklasse II
- entspricht EN 60598-1
- mit Symbol, wie auf dem Bild dargestellt
- Laserdruck-Möglichkeit von beliebigen Symbolen

LED LAMP DUAL COLOUR 250V~ 2x0,4W 2M

- signaling dual colour (red/green) LED lamp
- supply voltage 230V~ 50Hz 2x0,4W
- Class II
- in accordance with EN 60598-1
- diffuser includes graphics as shown
- possible customized laser printing on diffuser

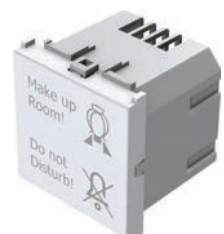

3D-LED-LAMPE ZWEIFARBIG 250V~2x0,4W 2M

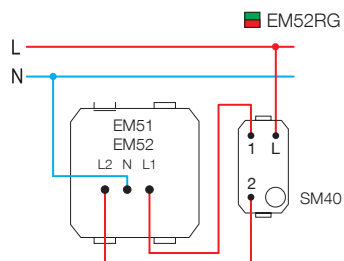

EM52RG

- 2-farbige LED-Signallampe (rot/grün) mit 3D-Symbol
- Versorgung 230V~ 50Hz 2x0,4W
- Schutzklasse II
- entspricht EN 60598-1
- Druckmöglichkeit von verschiedenen Symbolen nach Bestellung

LED LAMP 3D DUAL COLOUR

- signaling LED lamp, dual colour (red/green) with 3D symbol
- supply voltage 230V~ 50Hz 2x0,4W
- class II
- in accordance with EN 60598-1
- possible customized graphics on request

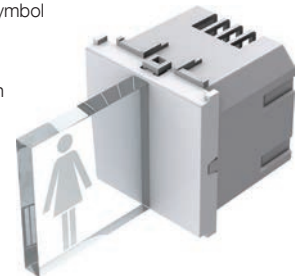

2M = 45 x 45

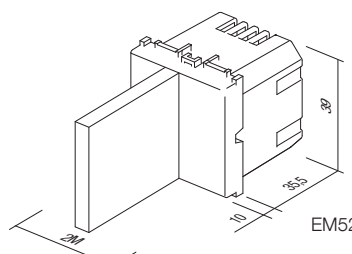
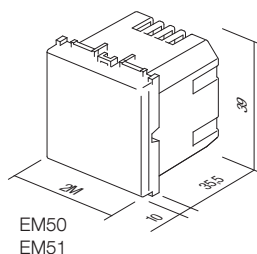



- EM70PW
- EM70SB
- EM70ES
- EM70IW

FINGERABDRUCKLESER ARX ONE 2M

- Fingerabdruckschalter komplett mit Innen-Relaiseinheit
- zum Aufschließen von elektrischen Schließern
- Kapazität 1000 Fingerabdrücke
- einfaches Programmieren durch zwei Tasten
- biometrischer Thermosensor
- Versorgung der inneren Relaiseinheit 110-230V~ 50-60Hz
- Ausgangsrelais 2x3A 12V DC
- 256-Bit-Verschlüsselung der Verbindung zwischen Schalter und Innen-Relaiseinheit
- entspricht EN 61000-1

FINGERPRINT SWITCH ARX ONE 2M

- fingerprint switch with included internal relay unit
- for unlocking electrical locks
- capacity 1000 fingerprints
- easy programming with two buttons
- thermal biometric sensor
- internal relay unit supply 110-230V~ 50-60Hz
- output relay 2x3A 12V DC
- 256-bit encrypted link between switch and internal relay unit
- in accordance with EN 61000-6-1



NEUER VERWALTER

1. Die ersten drei Fingerabdrücke haben Verwaltung srechte.
2. Die Eingabe verläuft auf die gleiche Art wie beim Hinzufügen eines Nutzers, jedoch ohne den zweiten Schritt.

ADMINISTRATOR ENROLMENT

1. The first three fingerprints enrolled are assigned administrative rights.
2. Administrator enrolment procedure is same as user enrolment without second step.

ZUFÜGEN EINES NUTZERS

1. Drücken Sie die linke Taste der Außeneinheit für 3 Sekunden. Die orangefarbene LED-Diode beginnt langsam zu blinken.
2. Der Verwalter streicht einmal mit dem Finger über den Sensor. Die orangefarbene LED-Diode beginnt schnell zu blinken.
3. Drücken Sie die linke Taste. Zur Bestätigung leuchtet die grüne LED-Diode und es ertönt ein Pfeifton für 1 Sekunde.
4. Die orangefarbene und die grüne LED-Diode blinken abwechselnd. Der Verwalter streicht viermal mit dem Finger über den Sensor. Jede Eingabe begleitet ein Pfeifton.
5. Ist der Fingerabdruck des Nutzers erfolgreich eingegeben, leuchtet die grüne LED-Diode und es ertönt ein Pfeifton.

USER ENROLMENT

1. The left button on the exterior unit is pressed for 3 seconds. The orange LED starts flashing slow.
2. An administrator swipes his finger over the sensor once. When he/she is identified, the orange LED will start flashing fast.
3. Press left button. The green LED confirms.
4. The orange and green LED will flash alternately. At this point the user swipes his/her finger over the sensor four times. Each successful entry is indicated by a buzz.
5. When the user is correctly enrolled, the green LED will flash and the buzzer will buzz at the same time.

LÖSCHEN EINES NUTZERS

1. Drücken Sie die linke Taste der Außeneinheit für 5 Sekunden. Die orangefarbene LED-Diode beginnt langsam zu blinken.
2. Der Verwalter streicht einmal mit dem Finger über den Sensor. Die erfolgreiche Identifikation wird bestätigt, wenn die grüne LED-Diode zu leuchten beginnt, und es ertönt ein Pfeifton.
3. Die rote und die grüne LED-Diode blinken abwechselnd. Der Nutzer, den Sie löschen möchten, streicht einmal mit dem Finger über den Sensor. Wird dieser Nutzer erfolgreich identifiziert, beginnt die grüne LED-Diode zu leuchten und es ertönt ein Pfeifton für 1 Sekunde. Der Nutzer ist erfolgreich gelöscht.

DELETING A USER

1. The right button on the exterior unit should be pressed for 5 seconds whereupon the orange LED will start flashing slow.
2. An administrator swipes his finger over the sensor once. When he/she is identified, the green LED will flash and the buzzer will buzz at the same time.
3. The red and green LED will flash alternately. Then the user swipes his finger over the sensor once. When the user is identified, the green LED flash and the buzzer will buzz once. The user has been successfully deleted from the system.

LÖSCHEN ALLER FINGERABDRÜCKE

1. Drücken Sie die beiden Tasten der Außeneinheit für 10 Sekunden. Die orangefarbene und die rote LED-Diode beginnen abwechselnd zu blinken.
2. Der Verwalter streicht einmal mit dem Finger über den Sensor. Die erfolgreiche Identifikation wird bestätigt, wenn die grüne LED-Diode zu leuchten beginnt, und es ertönt ein Pfeifton.
3. Die orangefarbene und die rote LED-Diode blinken erneut abwechselnd. Der Verwalter wiederholt den 2. Schritt.
4. Nach einer kurzen Pause leuchten die rote und die orangefarbene LED-Diode zusammen fünfmal auf und das Gerät pfeift fünfmal im gleichen Intervall. Alle Fingerabdrücke sind erfolgreich aus der Datenbank gelöscht.

DELETING ALL FINGERPRINTS

1. Press the left and right button on the exterior unit together for a period of 10 seconds whereupon the orange and red LED will flash alternately.
2. The administrator then swipes his/her finger once. Identification is confirmed when the green LED flashes and the buzzer buzzes at the same time.
3. The orange and red LED will flash alternately again. The administrator repeats second step.
4. The red and orange LED will flash and the buzzer will buzz five times simultaneously. All fingerprint templates will then have been deleted.

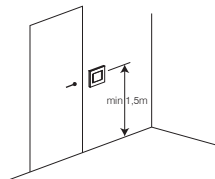

Dreifarbige LED-Kontrollbeleuchtung
three colour LED

Taste für das Zufügen eines Nutzers
button for user enrolment

Taste für das Löschen eines Nutzers
button for deleting a user

biometrischer Thermosensor
thermal biometric sensor

Außeneinheit
exterior unit

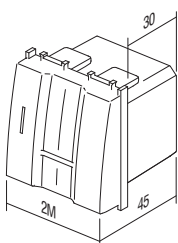

Innen-Relaiseinheit
interior relay unit

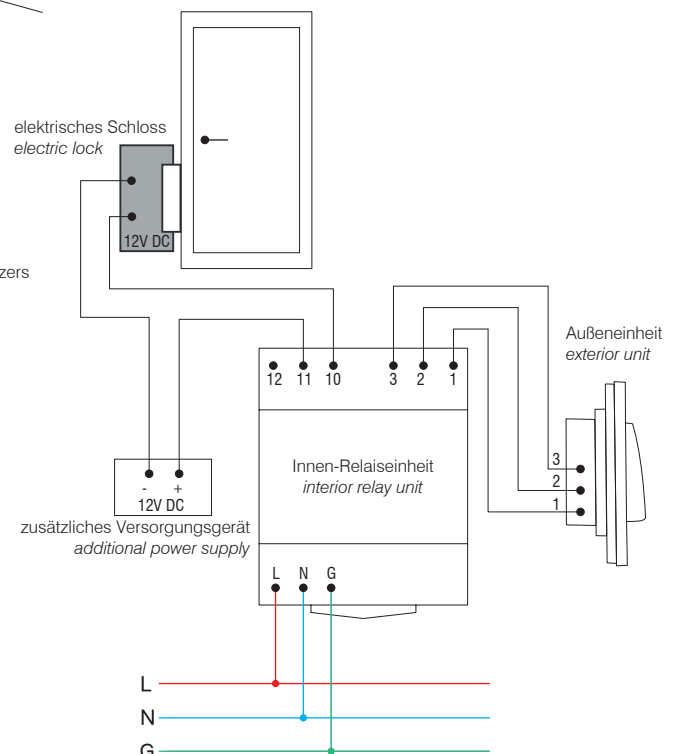
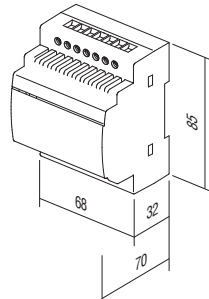

SUMMER 8VA 220V~ 1M



- EM90PW
- EM90SB
- EM90ES
- EM90IW

- Signalsummer
- der Summton dauert an, solange Sie auf die Taste drücken
- Versorgung 230V~ 50Hz 8VA

BUZZER 8VA 220V~1M

- signal buzzer
- the sound emission has the same lasting time as the control operation
- supply voltage 230V~ 50Hz 8VA



SUMMER 8VA 12V~ 1M



- EM91PW
- EM91SB
- EM91ES
- EM91IW

- Signalsummer
- der Summton dauert an, solange Sie auf die Taste drücken
- Versorgung 12V~ 50Hz 8VA

BUZZER 8VA 12V~1M

- signal buzzer
- the sound emission has the same lasting time as the control operation
- supply voltage 12V~ 50Hz 8VA



KLINGEL 8VA 230V~ 1M



- EM92PW
- EM92SB
- EM92ES
- EM92IW

- Signalklingel
- der Klingelton dauert an, solange Sie auf die Taste drücken
- Versorgung 230V~ 50Hz 8VA

BELL 8VA 230V~1M

- signal bell
- the sound emission has the same lasting time as the control operation
- supply voltage 230V~ 50Hz 8VA



KLINGEL 8VA 12V~ 1M



- EM93PW
- EM93SB
- EM93ES
- EM93IW

- Signalklingel
- der Klingelton dauert an, solange Sie auf die Taste drücken
- Versorgung 12V~ 50Hz 8VA

BELL 8VA 12V~1M

- signal bell
- the sound emission has the same lasting time as the control operation
- supply voltage 12V~ 50Hz 8VA

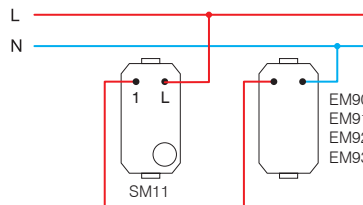
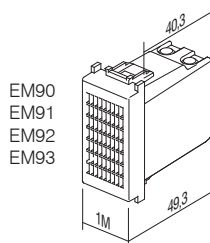

LAUTSTÄRKENREGLER FÜR 100 V AUDIOLINE 35W 2M



- EM95PW
- EM95SB
- EM95ES
- EM95IW

- Lautstärkenregler (Attenuator) für 100 V Audiosysteme
- Nennleistung 35 W (max. 45 W), 6-stufige Lautstärkenregelung
- geeignet für den Einbau in tiefe Dosen (min. 60 mm)
- nicht geeignet für den Einbau in Dosen mit Tiefe 45 mm und Gehäuse CUBO IP20
- nur für Gebrauch im Innenbereich geeignet

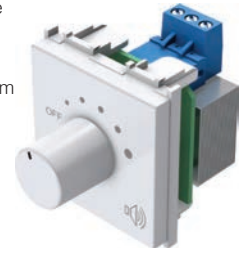

VOLUME CONTROL 100V AUDIO LINE 35W 2M

- volume control (attenuator) for 100V audio systems
- power rating 35W (max. 45W), 6 steps volume control
- suitable for boxes min. 60 mm deep
- not suitable for installation in 45 mm deep boxes and surface mount boxes CUBO IP20
- for indoor use only

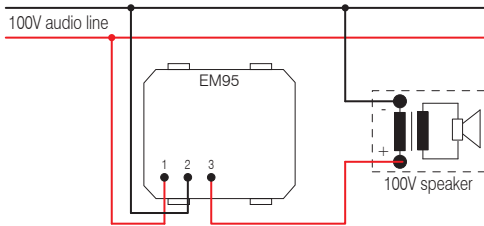

NIEDEROHMIGER LAUTSTÄRKENREGLER 4-8 Ω 35W 2M



- EM96PW
- EM96SB
- EM96ES
- EM96IW

- Lautstärkenregler für niederohmige Ausgänge 4-8 Ω 35W
- zum Anschluss an Hi-Fi-Geräte
- Nennleistung 35 W, 6-stufige Lautstärkenregelung
- geeignet für den Einbau in tiefe Dosen (min. 60 mm)
- nicht geeignet für den Einbau in Dosen mit Tiefe 45 mm und Gehäuse CUBO IP20
- nur für Gebrauch im Innenbereich geeignet



VOLUME CONTROL 4-8 Ω 35W 2M

- volume control (attenuator) for low voltage outputs 4-8 Ω, 35W
- for connecting to Hi-Fi systems
- power rating 35W, 6 steps volume control
- suitable for boxes min. 60 mm deep
- not suitable for installation in 45 mm deep boxes and surface mount boxes CUBO IP20
- for indoor use only

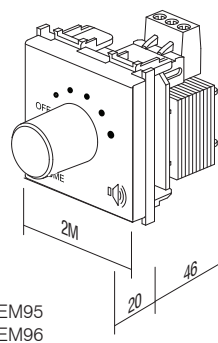
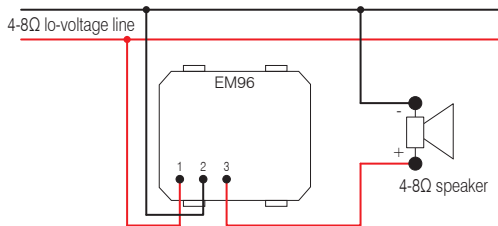

EM95
EM96

S E T S C M

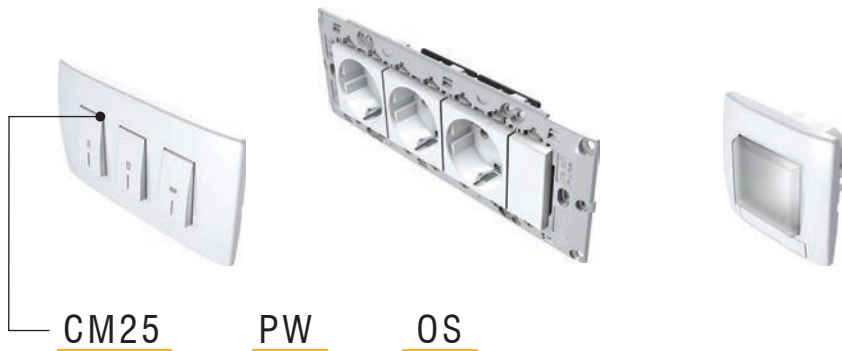

Typ type	Bezeichnung description	Technische daten technical data	Größe size	Farbe colour	Optionsbezeichnung 1 optional data 1
CM10	SET STECKDOSE 2x SCHUKO SOCKET SET 2x SCHUKO	2P+E 16A 250V~	4M	<input type="checkbox"/> PW Weiß-glänzend polar white	<input type="checkbox"/> OL Rahmen LINE cover plate LINE
CM11	SET STECKDOSE 3x SCHUKO SOCKET SET 3x SCHUKO	2P+E 16A 250V~	7M	<input type="checkbox"/> SB Schwarz-matt soft touch black	<input type="checkbox"/> OS Rahmen SOFT cover plate SOFT
CM15	SET VERDRAHTUNGSBRÜCKEN FARBIG LINK WIRE SET	3x1,5mm ²	1M	<input type="checkbox"/> ES Silber-matt elox silver <input type="checkbox"/> IW Beige-glänzend ivory white	

SET STECKDOSEN 2x SCHUKO 2P+E 16A 250V~ 4M

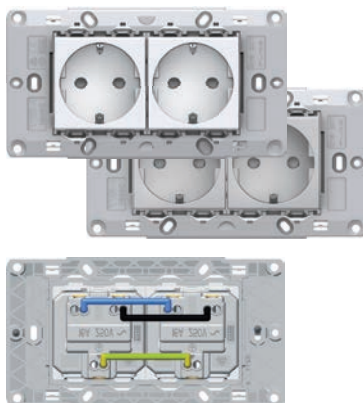

- CM10PW
- CM10ES

- Steckdosen-Set 2x Schuko VM10 2P+E 16A 250V~
- Steckdosen verbunden durch Verdrahtungsbrücken CM16
- mit Träger 4M ohne Schrauben
- für die Befestigung verwenden Sie Schrauben CM17, CM18 oder CM19
- Schraubklemmen 1,5-2,5 mm²
- entspricht IEC 60884-1, CEE7

SOCKETS SET 2x SCHUKO 2P+E 16A 250V~ 4M

- socket set 2x schuko VM10 2P+E 16A 250V~
- prewired with link wires CM16
- with mounting frame 4M without screws
- for mounting frame fixing use screws CM17, CM18 or CM19
- screw contacts 1.5-2.5 mm²
- in accordance with IEC-60884-1, CEE7

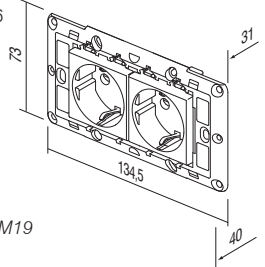

SET STECKDOSEN 3x SCHUKO 2P+E 16A 250V~ 7M

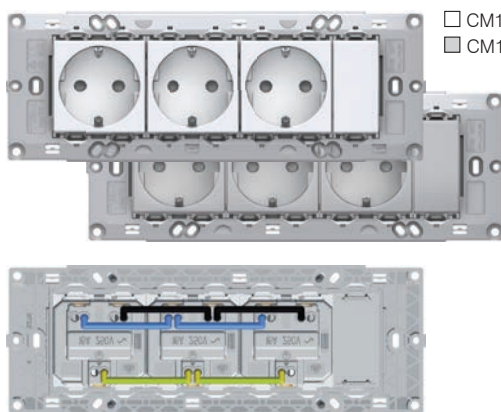

- CM11PW
- CM11ES

- Steckdosen-Set 3x Schuko VM10 2P+E 16A 250V~
- Steckdosen verbunden durch Verdrahtungsbrücken CM16
- mit Träger 7M ohne Schrauben
- für die Befestigung verwenden Sie Schrauben CM17, CM18 oder CM19
- Schraubklemmen 1,5-2,5 mm²
- entspricht IEC 60884-1, CEE7

SOCKETS SET 3x SCHUKO 2P+E 16A 250V~ 7M

- socket set 3x schuko VM10 2P+E 16A 250V~
- prewired with link wires CM16
- with mounting frame 7M without screws
- for mounting frame fixing use screws CM17, CM18 or CM19
- screw contacts 1.5-2.5 mm²
- in accordance with IEC-60884-1, CEE7

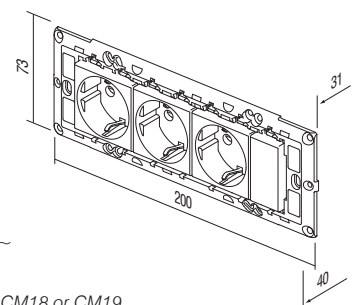

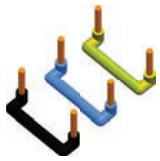

CM15

SET VERDRÄHTUNGSBRÜCKEN FARBIG 3x1,5mm² 1M

- Verdrahtungsbrücken-Set für Verbindung zweier Elemente mit Breite 1M
- Inkl. 10 schwarze, 10 blaue und 10 gelb-grüne Verdrahtungsbrücken

LINK WIRE SET 3x1,5mm² 1M

- link wire set to connect two elements size 1M
- includes 10 black, 10 blue and 10 yellow/green wires

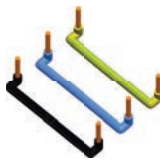
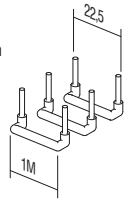

CM16

SET VERDRÄHTUNGSBRÜCKEN FARBIG 3x2,5mm² 2M

- Verdrahtungsbrücken-Set für Verbindung zweier Elemente mit Breite 2M
- Inkl. 10 schwarze, 10 blaue und 10 gelb-grüne Verdrahtungsbrücken

LINK WIRE SET 3x2,5mm² 2M

- link wire set to connect two elements size 2M
- includes 10 black, 10 blue and 10 yellow/green wires

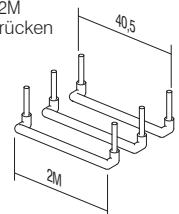

CM17
CM18
CM19

SET SCHRAUBEN 3,5

- Set mit Befestigungsschrauben für Montageträger NM32, NM40, NM41, NM70
- CM17 - l=20mm, 100 Stück
- CM18 - l=35mm, 50 Stück
- CM19 - l=50mm, 50 Stück

SCREW SET 3,5

- screw set for fixing mounting frames NM30, NM32, NM40, NM41, NM70
- CM17 - l=20mm, 100pcs
- CM18 - l=35mm, 50pcs
- CM19 - l=50mm, 50pcs

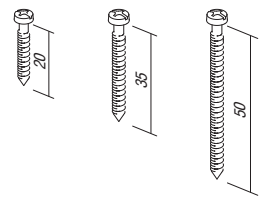

CM22PW

SCHALTER-SET IP44 2M

- geeignet für feuchte Räume
- Schutzart IP44 für alle Schalter Modul
- Schalter und Wippen sind nicht im Set enthalten
- Rahmen SOFT 2M mit Namensschild
- entspricht IEC 60669-1

SET SWITCHES IP44 2M

- for usage in humid areas
- IP44 protection provides for all Modul switches
- switches and buttons are not part of the set
- SOFT 2M cover plate with inscription plate
- in accordance with IEC 60669-1



CM23PW

SCHALTER-SET IP44 2M

- geeignet für feuchte Räume
- Schutzart IP44 nur in Kombination mit Steckdose mit Klappdeckel (VM11, VM41)
- Steckdosen sind nicht im Set enthalten
- Rahmen SOFT 2M mit Namensschild
- entspricht IEC 60884-1

SET SOCKETS IP44 2M

- for usage in humid areas
- IP44 protection can be achieved only in combination with covered socket (VM11, VM41)
- sockets are not part of the set
- SOFT 2M cover plate with inscription plate
- in accordance with IEC 60884-1



CM25PWOL
 CM25IWOL
 CM25PWOS
 CM25IWOS

BADEZIMMER-SET 3x20AX 250V~ 4M

- Stecker-Set 3xSM12 20AX 250V~ mit Montageträger und Rahmen
- Schraubklemmen 1,5-2,5 mm²
- entspricht EN 60669-1
- Befestigungsmöglichkeit auf schon eingebaute Dosen mit Befestigungsmaßen von 108 bis 135 mm bzw. auf Dosen mit Breite 4M
- Höhe des Rahmens 90mm

SWITCH SET FOR BATHROOM 3x20AX 250V~ 4M

- switch set 3xSM12 20AX 250V~ with mounting frame and cover plate
- screw contacts 1.5-2.5mm²
- in accordance with EN 60669-1
- universal solution for renovation on boxes with fixing dimensions 108-135mm or boxes 4M size
- cover plate height 90mm

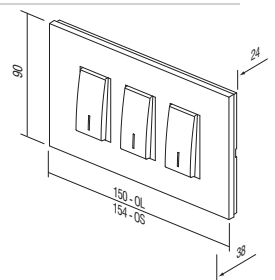



NM41

MONTAGETRÄGER FÜR BADEZIMMER-SET 4M

- Universal-Montageträger für Badezimmer-Set mit Schrauben
- Befestigungsmöglichkeit auf schon eingebaute Rechteckdosen mit Befestigungsmaßen von 108 bis 135 mm bzw. auf Dosen mit Breite 4M
- entspricht EN 60669-1

MOUNTING FRAME BATHROOM SET 4M

- universal mounting frame for bathroom set with screws
- universal solution for mounting on rectangular boxes with fixing dimensions 108-135mm or boxes 4M size
- in accordance with EN 60669-1

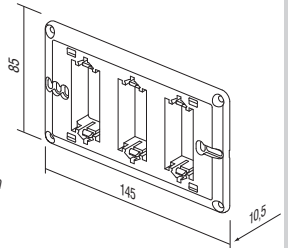

- OL41PW
- OL41NB
- OL41IW
- OL41ES
- OL41SG
- OL41IB
- OL41MG

RAHMEN LINE FÜR BADEZIMMER-SET

- dekorativer Rahmen LINE für Badezimmer-Set
- Höhe 90mm
- entspricht EN 60669-1

COVER PLATE LINE BATHROOM SET

- decorative cover plate bathroom set LINE
- height 90mm
- in accordance with EN 60669-1

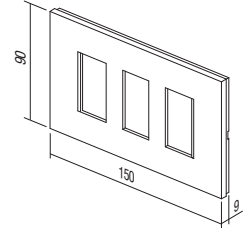

- OS41PW
- OS41NB
- OS41IW
- OS41ES
- OS41SG
- OS41SB
- OS41WE

RAHMEN SOFT FÜR BADEZIMMER-SET

- dekorativer Rahmen SOFT für Badezimmer-Set
- Höhe 90mm
- entspricht EN 60669-1

COVER PLATE SOFT BATHROOM SET

- decorative cover plate bathroom set SOFT
- height 90mm
- in accordance with EN 60669-1

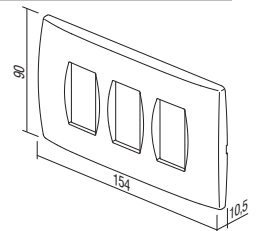

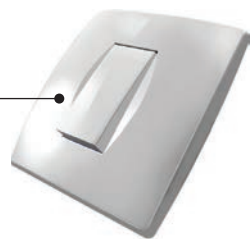



TM11

AW

IN

Typ type	Bezeichnung description	Breite size	Farbe colour	Optionsbezeichnung 1 optional data 1
TM11	WIPPE BUTTON	1M	<input type="checkbox"/> AW Antibakterien-Weiß antibacterial white	 NT neutral neutral
TM21	BLLENDE BLANK	1M		 IN Indikator indicator
VM10	STECKDOSE SOCKET	2M		
.

ANTIBAKTERIENPROGRAMM MODUL

- Schalter und Steckdosen werden tagtäglich dem Kontakt mit zahlreichen Menschen ausgesetzt und sind aufgrund dessen häufig Stellen der Entwicklung und Verbreitung von Bakterien.
- Dank seiner antibakteriellen Eigenschaften ist Silber bereits seit 3 Jahrtausenden ein sicheres und effizientes Desinfektionsmittel, denn es ist vollkommen natürlich und gesundheits- und umweltfreundlich.
- Ein besonderer antibakterieller Zusatz von Silberionen gewährleistet einen langfristigen, zuverlässigen und effizienten Schutz gegen die Entwicklung und Verbreitung von verschiedenen Bakterien, Viren, Mikroben und Pilzen.
- Antibakterienschutz bedeutet höhere Hygiene, Reinheit und Gesundheit für Menschen.
- Das Antibakterienprogramm Modul eignet sich zur Verwendung überall dort, wo strenge Hygienebedingungen herrschen (Krankenhäuser, Gesundheitszentren, pharmazeutische Einrichtungen, Pflegeheime, Laboratorien, Restaurants, Hotels, Flughäfen, Bus- und Bahnstationen, Geschäfts- und Einkaufszentren, öffentliche Einrichtungen usw.).
- Die Labortests wurden in einer unabhängigen Institution nach höchsten japanischen Normen JIS Z 2801 durchgeführt.
- Das Antibakterienprogramm Modul ermöglicht niedrige Kosten zur Gesunderhaltung.
- Die Form und Funktionalität des Antibakterienprogramms Modul ermöglichen die einfache Reinigung und Wartung.
- Das Antibakterienprogramm Modul wird mit antibakteriellen Wippen, Rahmen und Steckdosen zusammen mit klassischen Montageträgern und Schaltern kombiniert.
- Jedes Produkt ist aufgrund der einfacheren Identifikation an der Rückseite durch AW (antibacterial white) gekennzeichnet.

ANTIBACTERIAL PROGRAM MODUL

- switches and sockets are daily touched by many people, so this is a common place for development and spread of bacteria
- thanks to its natural antibacterial characteristics silver has been used for three millennia as a safe and effective disinfectant, since it is completely natural, healthy and environmentally friendly
- special antibacterial silver ions additive provides long-term, reliable and effective protection against the development and spread of bacteria, viruses, microbes and fungi
- antibacterial protection ensures hygiene, cleanliness and health for people
- perfectly suitable for use in environments with strict hygiene conditions (hospitals, health centers, pharmaceutical facilities, homes for elderly, nursing homes, laboratories, restaurants, hotels, airports, bus and railway stations, business and shopping areas, public institutions ...)
- independent laboratory testings have been carried out in accordance with highest Japanese standards JIS Z 2801
- low cost for providing human health
- design and functionality of antibacterial program MODUL allow easy cleaning and maintenance
- antibacterial buttons, cover plates and sockets are combined with classic mounting frames and switches
- products are labelled on the back with AW (antibacterial white)

A N T I B A C T E R I A L P R O G R A M M M O D U L

WIPPE 1M



□ TM11AW

- Wippe auswechselbar, Breite 1M
- entspricht EN 60669-1
- Antibakterienschutz gemäß JIS Z 2801

BUTTON 1M

- replaceable button 1M
- in accordance with EN 60669-1
- antibacterial protection in accordance with JIS Z 2801



KONTROLLWIPPE 1M



□ TM11AWIN

- Wippe auswechselbar, Breite 1M
- entspricht EN 60669-1
- Antibakterienschutz gemäß JIS Z 2801

BUTTON 1M INDICATOR

- replaceable button 1M
- in accordance with EN 60669-1
- antibacterial protection in accordance with JIS Z 2801



WIPPE 2M



□ TM12AW

- Wippe auswechselbar, Breite 2M mit Wippenträger
- zur Erweiterung von Schaltern oder Tastern in Breite 1M auf Breite 2M
- entspricht EN 60669-1
- Antibakterienschutz gemäß JIS Z 2801

BUTTON 2M

- replaceable button 2M with button carrier
- to upgrade switch or push button from size 1M to size 2M
- in accordance with EN 60669-1
- antibacterial protection in accordance with JIS Z 2801



KONTROLLWIPPE 2M



□ TM12AWIN

- Wippe auswechselbar, Breite 2M mit Wippenträger
- zur Erweiterung von Schaltern oder Tastern in Breite 1M auf Breite 2M
- entspricht EN 60669-1
- Antibakterienschutz gemäß JIS Z 2801

BUTTON 2M INDICATOR

- replaceable button 2M with button carrier
- to upgrade switch or push button from size 1M to size 2M
- in accordance with EN 60669-1
- antibacterial protection in accordance with JIS Z 2801



BLENDE 1M



□ TM21AW

- zum Ausfüllen von leeren Stellen
- entspricht EN 60669-1
- Antibakterienschutz gemäß JIS Z 2801

BLANK 1M

- blank modul to fill up empty spaces
- in accordance with EN 60669-1
- antibacterial protection in accordance with JIS Z 2801



BLENDE 2M



□ TM22AW

- zum Ausfüllen von leeren Stellen
- entspricht EN 60669-1
- Antibakterienschutz gemäß JIS Z 2801

BLANK 2M

- blank modul to fill up empty spaces
- in accordance with EN 60669-1
- antibacterial protection in accordance with JIS Z 2801





□ VM10AW

STECKDOSE SCHUKO+KS 2P+E 16A 250V~ 2M

- 2P+E Steckdose mit Schutzkontakt
- 16A 250V~, Typ VM10
- entspricht IEC 60884-1, CEE7
- Schraubklemmen 1,5-2,5 mm²
- KS – Kinderschutz gegen Berührung stromführender Teile
- Antibakterienschutz gemäß JIS Z 2801



SOCKET SCHUKO+KS 2P+E 16A 250V~ 2M

- 2P+E schuko
- 16A 250V~, type VM10
- in accordance with IEC 60884-1, CEE7
- screw contacts 1.5-2.5 mm²
- KS built-in child protection - shuttered live contacts
- antibacterial protection in accordance with JIS Z 2801



□ VM11AW

STECKDOSE SCHUKO+KS+KLAPPDECKEL 2P+E 16A 250V~ 2M

- 2P+E Steckdose mit Schutzkontakt mit Klappdeckel
- 16A 250V~, Typ VM11
- entspricht IEC 60884-1, CEE7
- Schraubklemmen 1,5-2,5 mm²
- KS – Kinderschutz gegen Berührung stromführender Teile
- Antibakterienschutz gemäß JIS Z 2801



SOCKET SCHUKO+KS+COVER

- 2P+E 16A 250V~ 2M
- 2P+E schuko+cover
- 16A 250V~, type VM11
- in accordance with IEC 60884-1, CEE7
- screw contacts 1.5-2.5 mm²
- KS built-in child protection - shuttered live contacts
- antibacterial protection in accordance with JIS Z 2801



□ VM20AW

STECKDOSE EURO+KS 2P 10A 250V~ 1M

- 2P Eurosteckdose
- 10A 250V~, Typ VM20
- entspricht IEC 60884-1, CEE7
- Schraubklemmen 1,5-2,5 mm²
- KS – Kinderschutz gegen Berührung stromführender Teile
- Antibakterienschutz gemäß JIS Z 2801



SOCKET EURO+KS 2P 10A 250V~ 1M

- 2P Euro
- 10A 250V~, type VM20
- in accordance with IEC 60884-1, CEE7
- screw contacts 1.5-2.5 mm²
- KS built-in child protection - shuttered live contacts
- antibacterial protection in accordance with JIS Z 2801



□ KM11AW

TV-ENDDOSE 1dB 1M

- TV-Enddose
- Übertragungsbandbreite 5-2400 MHz
- Dämpfung < 1 dB
- entspricht EN 50083-1
- Schraubklemmen
- Antibakterienschutz gemäß JIS Z 2801



SOCKET TV END-LINE 1dB 1M

- TV end-line
- frequency range 5÷2400 MHz
- reduction < 1 dB
- in accordance with EN 50083-1
- screw contacts
- antibacterial protection in accordance with JIS Z 2801

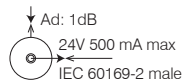

□ KM35AW

ADAPTER KS 1M

- KS – Keystone-Befestigungsstandard
- AMP, Avaya, Brandrex, FMT, Mfico, Tyco usw.
- ohne Kommunikationsmodul
- Antibakterienschutz gemäß JIS Z 2801



ADAPTER KS 1M

- KS keystone fixing standard
- AMP, Avaya, Brandrex, FMT, Mfico, Tyco, ...
- communication module not included
- antibacterial protection in accordance with JIS Z 2801

A N T I B A C T E R I A L P R O G R A M M M O D U L



OS20AW

RAHMEN SOFT 2M

- dekorativer Rahmen SOFT 2M
- entspricht EN 60669-1
- Antibakterienschutz gemäß JIS Z 2801

COVER PLATE SOFT 2M

- decorative cover plate SOFT 2M
- in accordance with EN 60669-1
- antibacterial protection in accordance with JIS Z 2801



OS24AW

RAHMEN SOFT 2x2M

- dekorativer Rahmen SOFT 2x2M
- Horizontal- oder Vertikalmontage
- entspricht EN 60669-1
- Antibakterienschutz gemäß JIS Z 2801

COVER PLATE SOFT 2x2M

- decorative cover plate SOFT 2x2M
- horizontal or vertical mounting
- in accordance with EN 60669-1
- antibacterial protection in accordance with JIS Z 2801



OS26AW

RAHMEN SOFT 3x2M

- dekorativer Rahmen SOFT 3x2M
- Horizontal- oder Vertikalmontage
- entspricht EN 60669-1
- Antibakterienschutz gemäß JIS Z 2801

COVER PLATE SOFT 3x2M

- decorative cover plate SOFT 3x2M
- horizontal or vertical mounting
- in accordance with EN 60669-1
- antibacterial protection in accordance with JIS Z 2801



OS30AW

RAHMEN SOFT 3M

- dekorativer Rahmen SOFT 3M
- entspricht EN 60669-1
- Antibakterienschutz gemäß JIS Z 2801

COVER PLATE SOFT 3M

- decorative cover plate SOFT 3M
- in accordance with EN 60669-1
- antibacterial protection in accordance with JIS Z 2801



OS40AW

RAHMEN SOFT 4M

- dekorativer Rahmen SOFT 4M
- entspricht EN 60669-1
- Antibakterienschutz gemäß JIS Z 2801

COVER PLATE SOFT 4M

- decorative cover plate SOFT 4M
- in accordance with EN 60669-1
- antibacterial protection in accordance with JIS Z 2801



OS70AW

RAHMEN SOFT 7M

- dekorativer Rahmen SOFT 7M
- entspricht EN 60669-1
- Antibakterienschutz gemäß JIS Z 2801

COVER PLATE SOFT 7M

- decorative cover plate SOFT 7M
- in accordance with EN 60669-1
- antibacterial protection in accordance with JIS Z 2801

Metall
metal

MH Geschmiedeter Stahl
hammered steel



ME Geätztes Eisen
etched iron

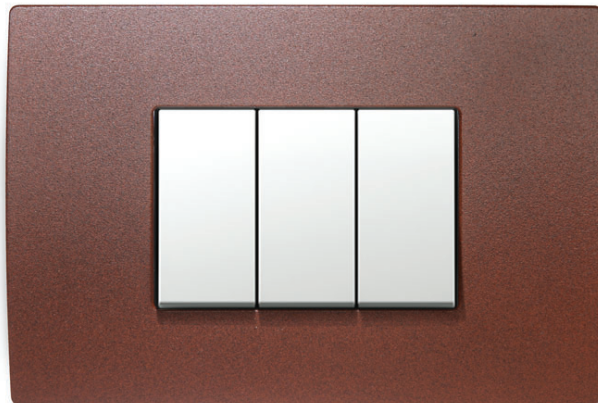

MS Satinsilber
satın silver

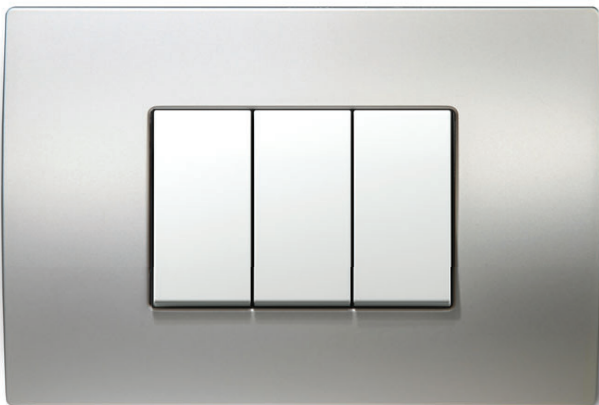

MN Satin-Nickel
satın nickel

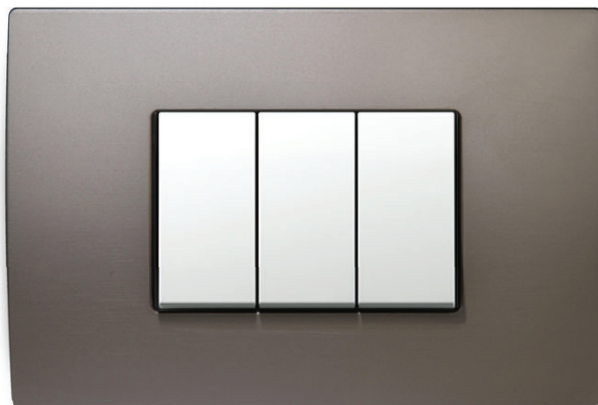

COVER PLATES PURE OP

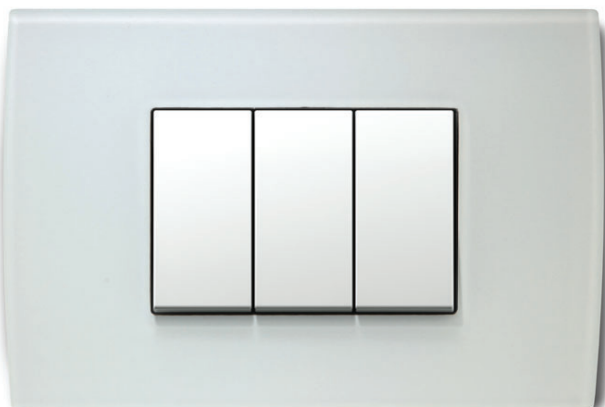
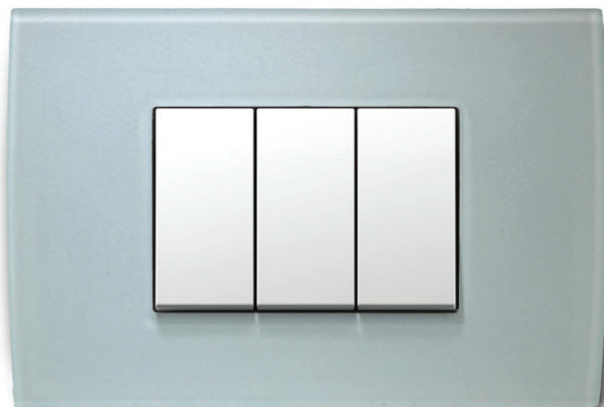
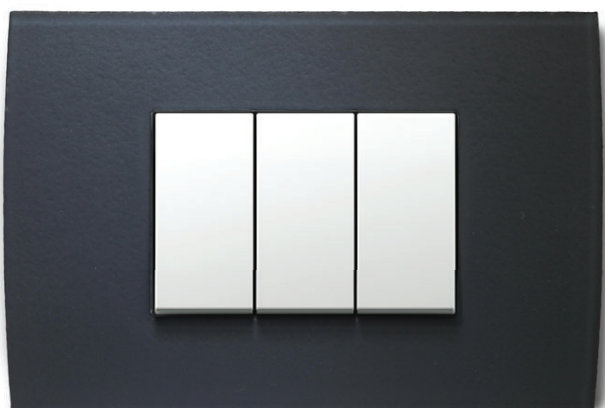
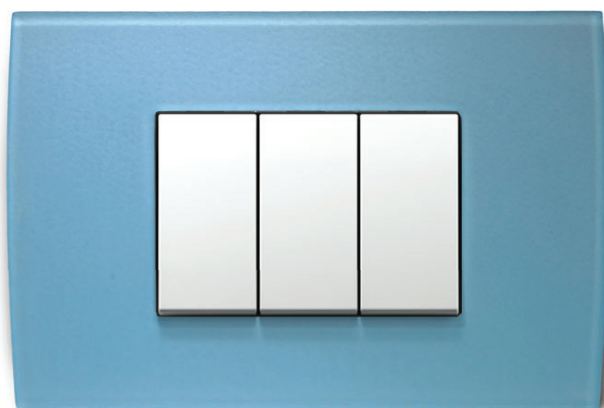
Holz
woodWB Bambus
bambooWW Nuss
walnutWM Ahorn
mapleWE Wenge
wengeGlas
glassGW Eisweiß
ice whiteGG Eisgrün
ice greenGY Eisgrau
ice greyGB Eisblau
ice blue



OP30

WB

Typ type	Bezeichnung description	Größe size	Farbe colour
OP13	RAHMEN PURE COVER PLATE PURE	1/3M	MH Geschmiedeter Stahl hammered steel WB Bambus bamboo GW Eisweiß ice white
OP20	RAHMEN PURE COVER PLATE PURE	2M	ME Geätztes Eisen etched iron WW Nuss walnut GG Eisgrün ice green
OP23	RAHMEN PURE COVER PLATE PURE	2/3M	MS Satinsilber satin silver WM Ahorn maple GY Eisgrün ice grey
...	MN Satin-Nickel satin nickel WE Wenge wenge GB Eisblau ice blue



OP20MH	OP20WB
OP20ME	OP20WW
OP20MS	OP20WM
OP20MN	OP20WE
	OP20GW
	OP20GG
	OP20GY
	OP20GB

RAHMEN PURE 2M

- dekorativer Rahmen PURE 2M
- entspricht EN 60669-1
- nur in Verbindung mit Montageträger NM24 oder NM25

COVER PLATE PURE 2M

- decorative cover plate PURE 2M
- in accordance with EN 60669-1
- only in combination with mounting frame NM24 or NM25

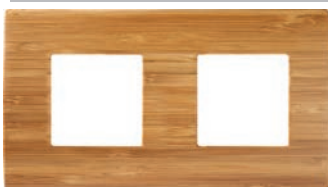

OP24MH	OP24WB
OP24ME	OP24WW
OP24MS	OP24WM
OP24MN	OP24WE
	OP24GW
	OP24GG
	OP24GY
	OP24GB

RAHMEN PURE 2x2M

- dekorativer Rahmen PURE 2x2M
- Horizontal- oder Vertikalmontage
- entspricht EN 60669-1
- nur in Verbindung mit Montageträger NM24 oder NM25

COVER PLATE PURE 2x2M

- decorative cover plate PURE 2x2M
- horizontal or vertical mounting
- in accordance with EN 60669-1
- only in combination with mounting frames NM24 or NM25



OP26MH	OP26WB
OP26ME	OP26WW
OP26MS	OP26WM
OP26MN	OP26WE
	OP26GW
	OP26GG
	OP26GY
	OP26GB

RAHMEN PURE 3x2M

- dekorativer Rahmen PURE 3x2M
- Horizontal- oder Vertikalmontage
- entspricht EN 60669-1
- nur in Verbindung mit Montageträger NM24 oder NM25

COVER PLATE PURE 3x2M

- decorative cover plate PURE 3x2M
- horizontal or vertical mounting
- in accordance with EN 60669-1
- only in combination with mounting frames NM24 or NM25

C O V E R P L A T E S P U R E O P



- | | |
|--------|--------|
| OP30MH | OP30WB |
| OP30ME | OP30WW |
| OP30MS | OP30WM |
| OP30MN | OP30WE |
| | OP30GW |
| | OP30GG |
| | OP30GY |
| | OP30GB |

RAHMEN PURE 3M

- dekorativer Rahmen PURE 3M
- entspricht EN 60669-1

COVER PLATE PURE 3M

- decorative cover plate PURE 3M
- in accordance with EN 60669-1



- | | |
|--------|--------|
| OP40MH | OP40WB |
| OP40ME | OP40WW |
| OP40MS | OP40WM |
| OP40MN | OP40WE |
| | OP40GW |
| | OP40GG |
| | OP40GY |
| | OP40GB |

RAHMEN PURE 4M

- dekorativer Rahmen PURE 4M
- entspricht EN 60669-1

COVER PLATE PURE 4M

- decorative cover plate PURE 4M
- in accordance with EN 60669-1



- | | |
|--------|--------|
| OP70MH | OP70WB |
| OP70ME | OP70WW |
| OP70MS | OP70WM |
| OP70MN | OP70WE |
| | OP70GW |
| | OP70GG |
| | OP70GY |
| | OP70GB |

RAHMEN PURE 7M

- dekorativer Rahmen PURE 7M
- entspricht EN 60669-1

COVER PLATE PURE 7M

- decorative cover plate PURE 7M
- in accordance with EN 60669-1



- | | |
|--------|--------|
| OP13MH | OP13WB |
| OP13ME | OP13WW |
| OP13MS | OP13WM |
| OP13MN | OP13WE |
| | OP13GW |
| | OP13GG |
| | OP13GY |
| | OP13GB |

RAHMEN PURE 1/3M

- dekorativer Rahmen PURE 1/3M
- entspricht EN 60669-1

COVER PLATE PURE 1/3M

- decorative cover plate PURE 1/3M
- in accordance with EN 60669-1



- | | |
|--------|--------|
| OP23MH | OP23WB |
| OP23ME | OP23WW |
| OP23MS | OP23WM |
| OP23MN | OP23WE |
| | OP23GW |
| | OP23GG |
| | OP23GY |
| | OP23GB |

RAHMEN PURE 2/3M

- dekorativer Rahmen PURE 2/3M
- entspricht EN 60669-1

COVER PLATE PURE 2/3M

- decorative cover plate PURE 2/3M
- in accordance with EN 60669-1

Basic
basic

PW Weiß-glänzend
polar white

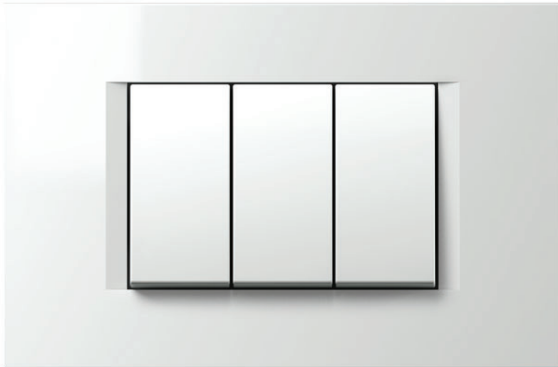

IW Beige-glänzend
ivory white

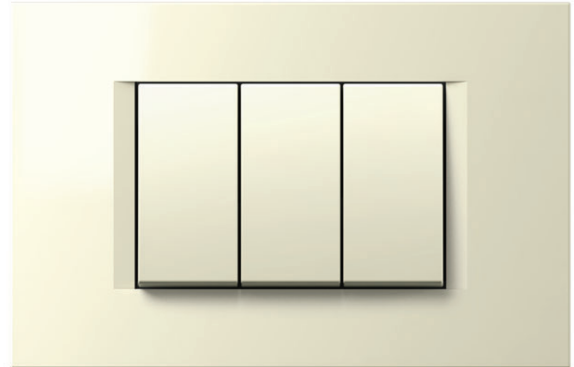

ES Silber-matt
elox silver

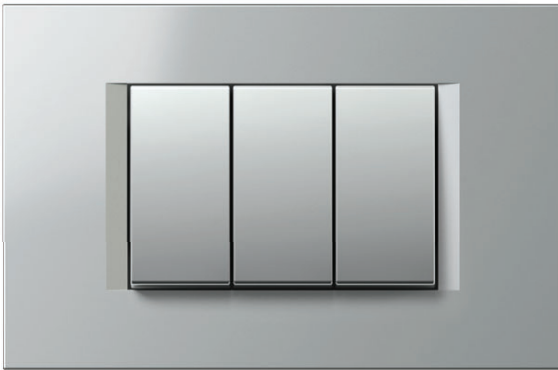

SB Schwarz-matt
soft touch black

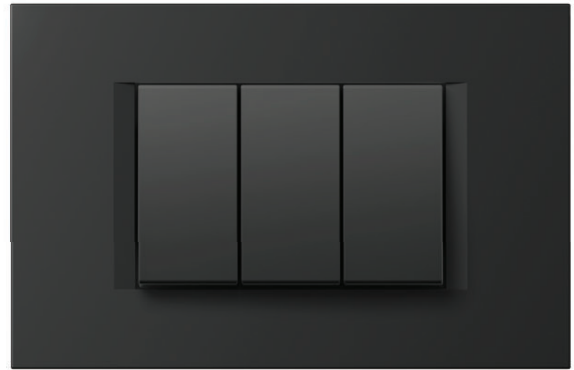

Dekor
decor

SG Sandgold
sand gold

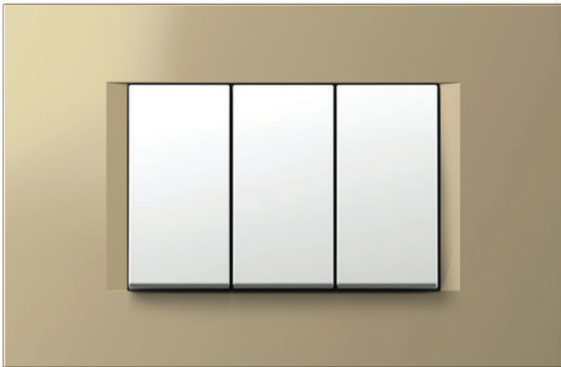

NB Schwarz-glänzend
night black

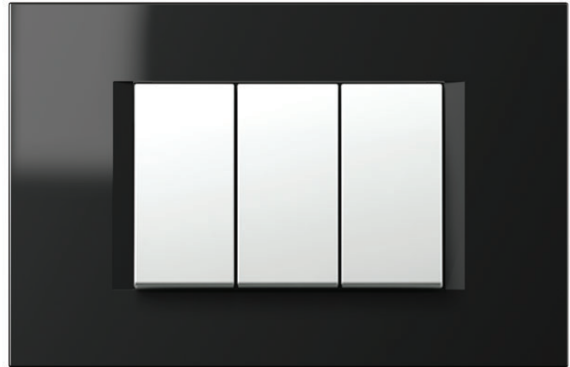

IB Impulse blau
impulse blue

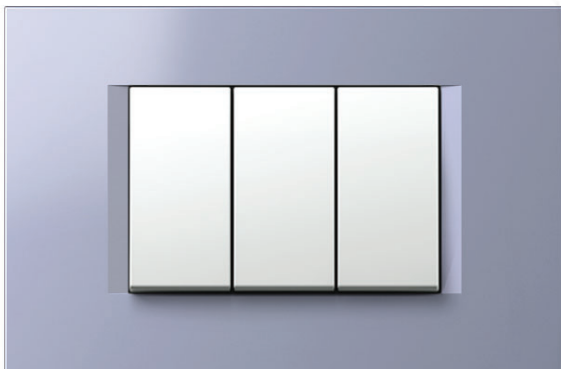

MG Minzgrün
mint green



SE Steinsmaragd
stone emerald



SW Steinweiß
stone white





OL30

PW

Typ type	Bezeichnung description	Größe size	Farbe colour	
OL10	RAHMEN LINE COVER PLATE LINE	1/2M	PW Weiß-glänzend polar white	SG Sandgold sand gold
OL13	RAHMEN LINE COVER PLATE LINE	1/3M	IW Beige-glänzend ivory white	NB Schwarz-glänzend night black
OL20	RAHMEN LINE COVER PLATE LINE	2M	ES Silber-matt elox silver	IB Impulse blau impulse blue
...	SB Schwarz-matt soft touch black	MG Minzgrün mint green



OL20PW	OL20SG
OL20IW	OL20NB
OL20ES	OL20IB
OL20SB	OL20MG
	OL20SE
	OL20SW

RAHMEN LINE 2M

- dekorativer Rahmen LINE 2M
- entspricht EN 60669-1

COVER PLATE LINE 2M

- decorative cover plate LINE 2M
- in accordance with EN 60669-1



OL24PW	OL24SG
OL24IW	OL24NB
OL24ES	OL24IB
OL24SB	OL24MG
	OL24SE
	OL24SW

RAHMEN LINE 2x2M

- dekorativer Rahmen LINE 2x2M
- Horizontal- oder Vertikalmontage
- entspricht EN 60669-1

COVER PLATE LINE 2x2M

- decorative cover plate LINE 2x2M
- horizontal or vertical mounting
- in accordance with EN 60669-1



OL26PW	OL26SG
OL26IW	OL26NB
OL26ES	OL26IB
OL26SB	OL26MG
	OL26SE
	OL26SW

RAHMEN LINE 3x2M

- dekorativer Rahmen LINE 3x2M
- Horizontal- oder Vertikalmontage
- entspricht EN 60669-1

COVER PLATE LINE 3x2M

- decorative cover plate LINE 3x2M
- horizontal or vertical mounting
- in accordance with EN 60669-1



OL28PW	OL28SG
OL28IW	OL28NB
OL28ES	OL28IB
OL28SB	OL28MG
	OL28SE
	OL28SW

RAHMEN LINE 4x2M











- dekorativer Rahmen LINE 4x2M
- Horizontal- oder Vertikalmontage
- entspricht EN 60669-1

COVER PLATE LINE 4x2M

- decorative cover plate LINE 4x2M
- horizontal or vertical mounting
- in accordance with EN 60669-1

COVER PLATES LINE OL



 OL30PW	 OL30SG
 OL30IW	 OL30NB
 OL30ES	 OL30IB
 OL30SB	 OL30MG
	 OL30SE
	 OL30SW









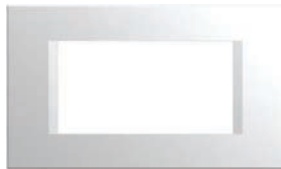

RAHMEN LINE 3M

- dekorativer Rahmen LINE 3M
- entspricht EN 60669-1

COVER PLATE LINE 3M

- decorative cover plate LINE 3M
- in accordance with EN 60669-1



 OL40PW	 OL40SG
 OL40IW	 OL40NB
 OL40ES	 OL40IB
 OL40SB	 OL40MG
	 OL40SE
	 OL40SW











RAHMEN LINE 4M

- dekorativer Rahmen LINE 4M
- entspricht EN 60669-1

COVER PLATE LINE 4M

- decorative cover plate LINE 4M
- in accordance with EN 60669-1



 OL70PW	 OL70SG
 OL70IW	 OL70NB
 OL70ES	 OL70IB
 OL70SB	 OL70MG
	 OL70SE
	 OL70SW

RAHMEN LINE 7M

- dekorativer Rahmen LINE 7M
- entspricht EN 60669-1

COVER PLATE LINE 7M

- decorative cover plate LINE 7M
- in accordance with EN 60669-1



 OL10PW	 OL10SG
 OL10IW	 OL10NB
 OL10ES	 OL10IB
 OL10SB	 OL10MG
	 OL10SE
	 OL10SW

RAHMEN LINE 1/2M

- dekorativer Rahmen LINE 1/2M
- entspricht EN 60669-1

COVER PLATE LINE 1/2M

- decorative cover plate LINE 1/2M
- in accordance with EN 60669-1



 OL13PW	 OL13SG
 OL13IW	 OL13NB
 OL13ES	 OL13IB
 OL13SB	 OL13MG
	 OL13SE
	 OL13SW

RAHMEN LINE 1/3M

- dekorativer Rahmen LINE 1/3M
- entspricht EN 60669-1

COVER PLATE LINE 1/3M

- decorative cover plate LINE 1/3M
- in accordance with EN 60669-1



 OL23PW	 OL23SG
 OL23IW	 OL23NB
 OL23ES	 OL23IB
 OL23SB	 OL23MG
	 OL23SE
	 OL23SW

RAHMEN LINE 2/3M

- dekorativer Rahmen LINE 2/3M
- entspricht EN 60669-1

COVER PLATE LINE 2/3M

- decorative cover plate LINE 2/3M
- in accordance with EN 60669-1

basic
basic

PW Weiß-glänzend
polar white

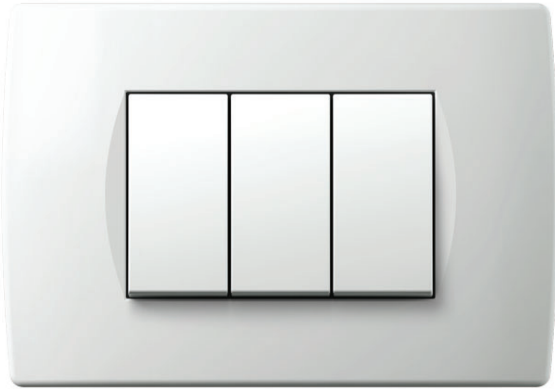

IW Beige-glänzend
ivory white

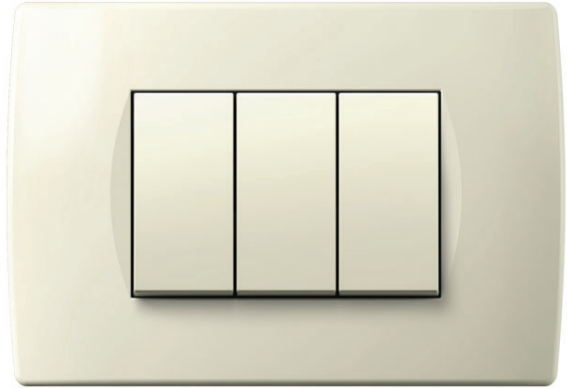

ES Silber-matt
elox silver

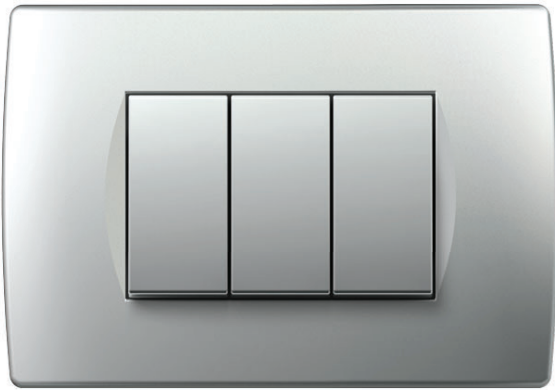

SB Schwarz-matt
soft touch black

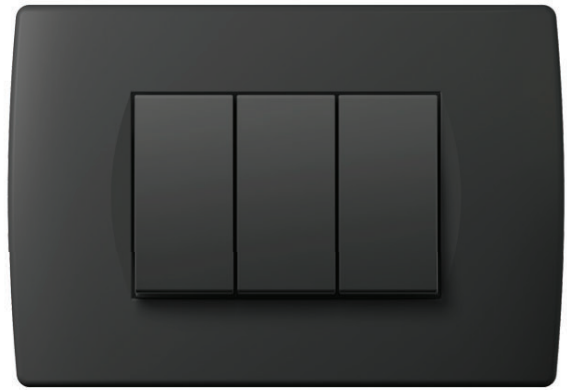

dekor
decor

SG Gold-matt
sand gold

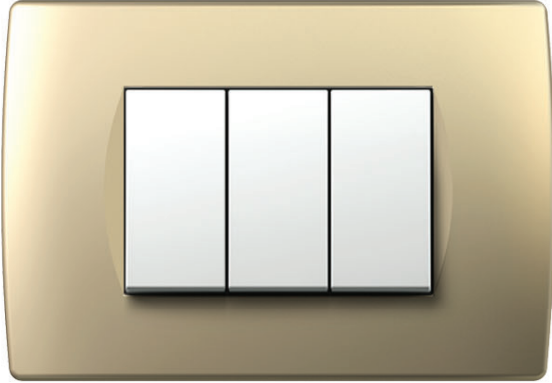

NB Schwarz-glänzend
night black

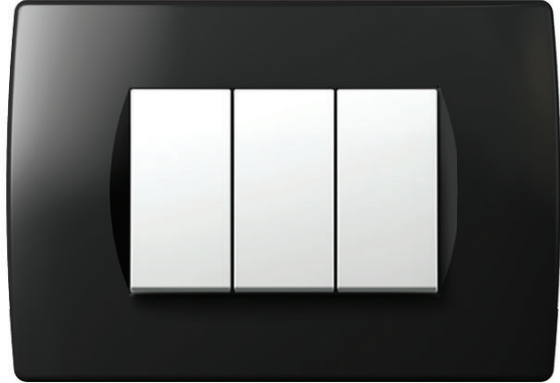

WP Fichte
spruce

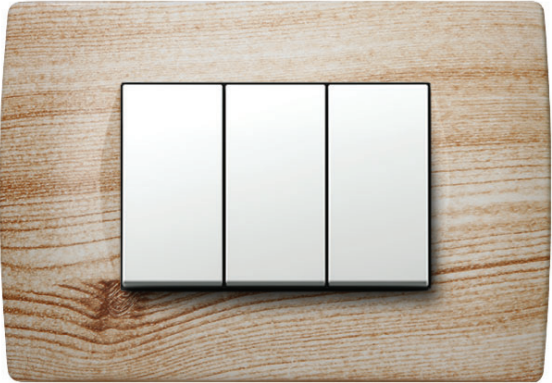

WW Nuss
walnut



WE Wenge
wenge

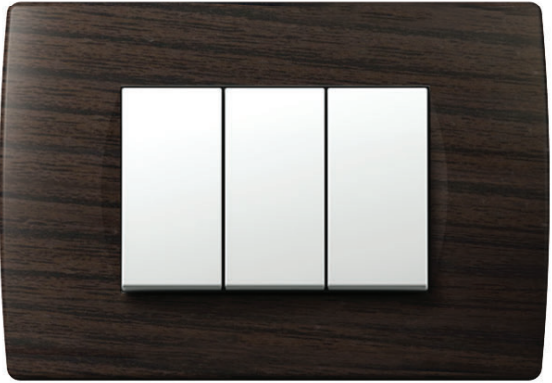



Typ type	Bezeichnung description	Größe size	Farbe colour						
OS10	RAHMEN SOFT COVER PLATE SOFT	1/2M	<table border="0"> <tr> <td> PW Weiß-glänzend <i>polar white</i></td> <td> SG Gold-matt <i>sand gold</i></td> <td> WP Fichte <i>spruce</i></td> </tr> </table>	PW Weiß-glänzend <i>polar white</i>	SG Gold-matt <i>sand gold</i>	WP Fichte <i>spruce</i>			
PW Weiß-glänzend <i>polar white</i>	SG Gold-matt <i>sand gold</i>	WP Fichte <i>spruce</i>							
OS13	RAHMEN SOFT COVER PLATE SOFT	1/3M	<table border="0"> <tr> <td> IW Beige-glänzend <i>ivory white</i></td> <td> NB Schwarz-glänzend <i>night black</i></td> <td> WW Nuss <i>walnut</i></td> </tr> </table>	IW Beige-glänzend <i>ivory white</i>	NB Schwarz-glänzend <i>night black</i>	WW Nuss <i>walnut</i>			
IW Beige-glänzend <i>ivory white</i>	NB Schwarz-glänzend <i>night black</i>	WW Nuss <i>walnut</i>							
OS20	RAHMEN SOFT COVER PLATE SOFT	2M	<table border="0"> <tr> <td> ES Silber-matt <i>elox silver</i></td> <td> WE Wenge <i>wenge</i></td> <td></td> </tr> <tr> <td> SB Schwarz-matt <i>soft touch black</i></td> <td></td> <td></td> </tr> </table>	ES Silber-matt <i>elox silver</i>	WE Wenge <i>wenge</i>		SB Schwarz-matt <i>soft touch black</i>		
ES Silber-matt <i>elox silver</i>	WE Wenge <i>wenge</i>								
SB Schwarz-matt <i>soft touch black</i>									



- | | |
|--------|--------|
| OS20PW | OS20SG |
| OS20IW | OS20NB |
| OS20ES | OS20WP |
| OS20SB | OS20WW |
| | OS20WE |

RAHMEN SOFT 2M

- dekorativer Rahmen SOFT 2M
- entspricht EN 60669-1

COVER PLATE SOFT 2M

- decorative cover plate SOFT 2M
- in accordance with EN 60669-1



- | | |
|--------|--------|
| OS24PW | OS24SG |
| OS24IW | OS24NB |
| OS24ES | OS24WP |
| OS24SB | OS24WW |
| | OS24WE |

RAHMEN SOFT 2x2M

- dekorativer Rahmen SOFT 2x2M
- Horizontal- oder Vertikalmontage
- entspricht EN 60669-1

COVER PLATE SOFT 2x2M

- decorative cover plate SOFT 2x2M
- horizontal or vertical mounting
- in accordance with EN 60669-1

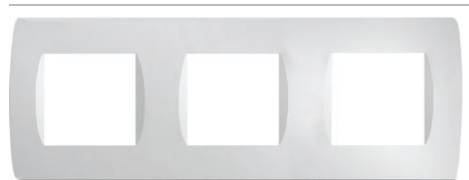

- | | |
|--------|--------|
| OS26PW | OS26SG |
| OS26IW | OS26NB |
| OS26ES | OS26WP |
| OS26SB | OS26WW |
| | OS26WE |

RAHMEN SOFT 3x2M

- dekorativer Rahmen SOFT 3x2M
- Horizontal- oder Vertikalmontage
- entspricht EN 60669-1

COVER PLATE SOFT 3x2M

- decorative cover plate SOFT 3x2M
- horizontal or vertical mounting
- in accordance with EN 60669-1



- | | |
|--------|--------|
| OS28PW | OS28SG |
| OS28IW | OS28NB |
| OS28ES | OS28WP |
| OS28SB | OS28WW |
| | OS28WE |

RAHMEN SOFT 4x2M

- dekorativer Rahmen SOFT 4x2M
- Horizontal- oder Vertikalmontage
- entspricht EN 60669-1

COVER PLATE SOFT 4x2M

- decorative cover plate SOFT 4x2M
- horizontal or vertical mounting
- in accordance with EN 60669-1

COVER PLATES SOFT OS



	OS30PW		OS30SG
	OS30IW		OS30NB
	OS30ES		OS30WP
	OS30SB		OS30WW
			OS30WE

RAHMEN SOFT 3M

- dekorativer Rahmen SOFT 3M
- entspricht EN 60669-1

COVER PLATE SOFT 3M

- decorative cover plate SOFT 3M
- in accordance with EN 60669-1



	OS40PW		OS40SG
	OS40IW		OS40NB
	OS40ES		OS40WP
	OS40SB		OS40WW
			OS40WE

RAHMEN SOFT 4M

- dekorativer Rahmen SOFT 4M
- entspricht EN 60669-1

COVER PLATE SOFT 4M

- decorative cover plate SOFT 4M
- in accordance with EN 60669-1



	OS70PW		OS70SG
	OS70IW		OS70NB
	OS70ES		OS70WP
	OS70SB		OS70WW
			OS70WE

RAHMEN SOFT 7M

- dekorativer Rahmen SOFT 7M
- entspricht EN 60669-1

COVER PLATE SOFT 7M

- decorative cover plate SOFT 7M
- in accordance with EN 60669-1



	OS72PW
	OS72IW
	OS72ES
	OS72SB

RAHMEN SOFT 2x7M

- dekorativer Rahmen SOFT 2x7M mit
Namensschild
- entspricht EN 60669-1

COVER PLATE SOFT 2x7M

- decorative cover plate SOFT 2x7M with
inscription plate
- in accordance with EN 60669-1



	OS10PW		OS10SG
	OS10IW		OS10NB
	OS10ES		OS10WP
	OS10SB		OS10WW
			OS10WE

RAHMEN SOFT 1/2M

- dekorativer Rahmen SOFT 1/2M
- entspricht EN 60669-1

COVER PLATE SOFT 1/2M

- decorative cover plate SOFT 1/2M
- in accordance with EN 60669-1



	OS13PW		OS13SG
	OS13IW		OS13NB
	OS13ES		OS13WP
	OS13SB		OS13WW
			OS13WE

RAHMEN SOFT 1/3M

- dekorativer Rahmen SOFT 1/3M
- entspricht EN 60669-1

COVER PLATE SOFT 1/3M

- decorative cover plate SOFT 1/3M
- in accordance with EN 60669-1



	OS23PW		OS23SG
	OS23IW		OS23NB
	OS23ES		OS23WP
	OS23SB		OS23WW
			OS23WE

RAHMEN SOFT 2/3M

- dekorativer Rahmen SOFT 2/3M
- entspricht EN 60669-1

COVER PLATE SOFT 2/3M

- decorative cover plate SOFT 2/3M
- in accordance with EN 60669-1

LASERDRUCK AUF RAHMEN



- Laserdruck von beliebigen Symbolen auf gekennzeichnete Stellen
- Fertigung auf Bestellung
- geeignet für Rahmen OL, OS

LASER PRINT ON COVER PLATES

- laser print of any graphics
- made on request
- suitable for cover plates OL, OS

DEKORATION DER RAHMEN









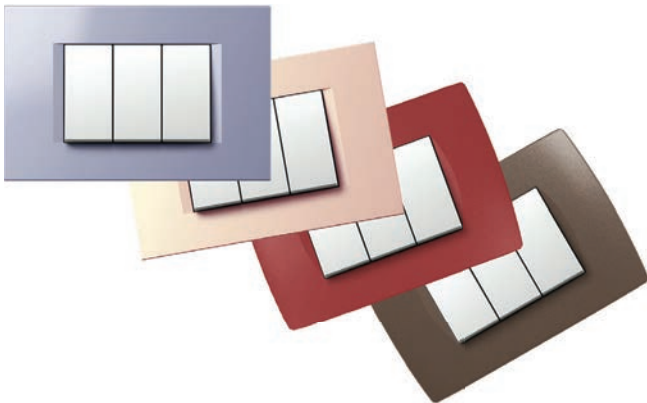

- Muster und Farben nach Wahl
- Fertigung auf Bestellung
- geeignet für Rahmen OL, OS

COVER PLATES DECORATIONS

- customised textures and colours
- made on request
- suitable for cover plates OL, OS

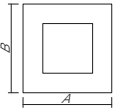
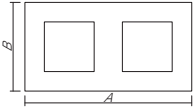
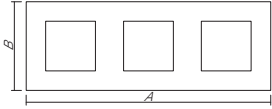
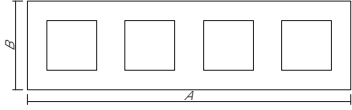

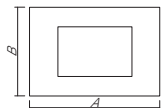
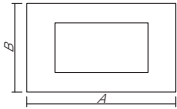
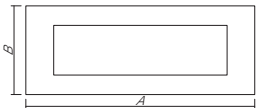
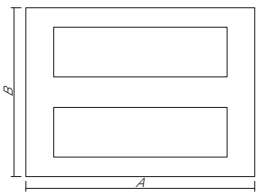
R A H M E N

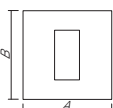
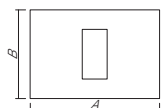
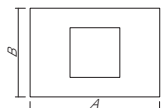
	 line Ax B	 soft Ax B	 PURE Ax B
2M 	80 x 80 mm	84 x 84 mm	93 x 90 mm
2x2M 	151 x 80 mm	155 x 84 mm	164 x 90 mm
3x2M 	222 x 80 mm	226 x 84 mm	235 x 90 mm
4x2M 	293 x 80 mm	297 x 84 mm	
			
3M 	122 x 80 mm	122 x 84 mm	134 x 90 mm
4M 	149 x 80 mm	144 x 84 mm	157 x 90 mm
7M 	207 x 80 mm	212 x 84 mm	224 x 90 mm
2x7M 		212 x 158 mm	
			
1/2M 	80 x 80 mm	84 x 84 mm	
1/3M 	122 x 80 mm	122 x 84 mm	134 x 90 mm
2/3M 	122 x 80 mm	122 x 84 mm	134 x 90 mm

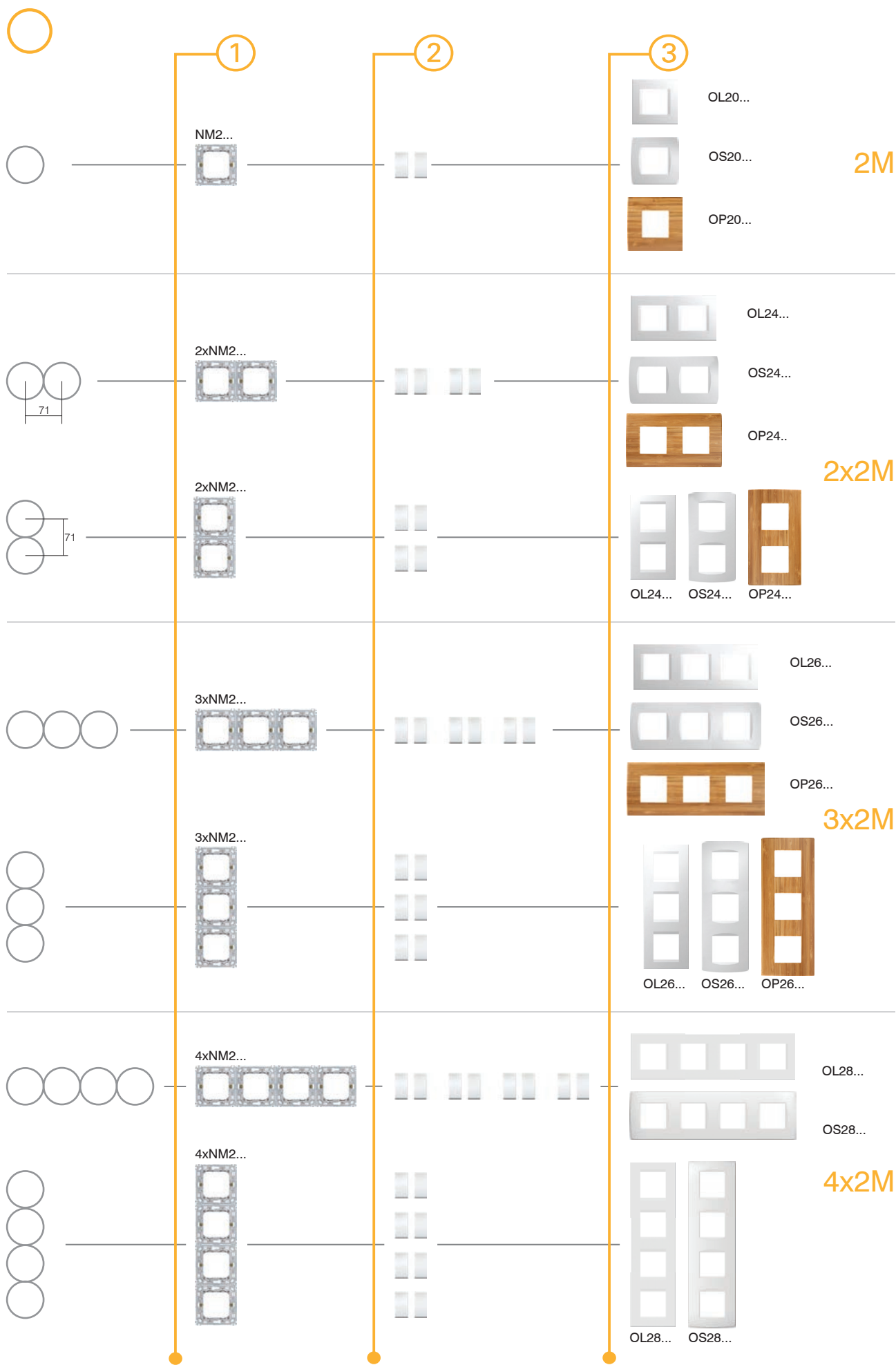

C O M B I N A T I O N S

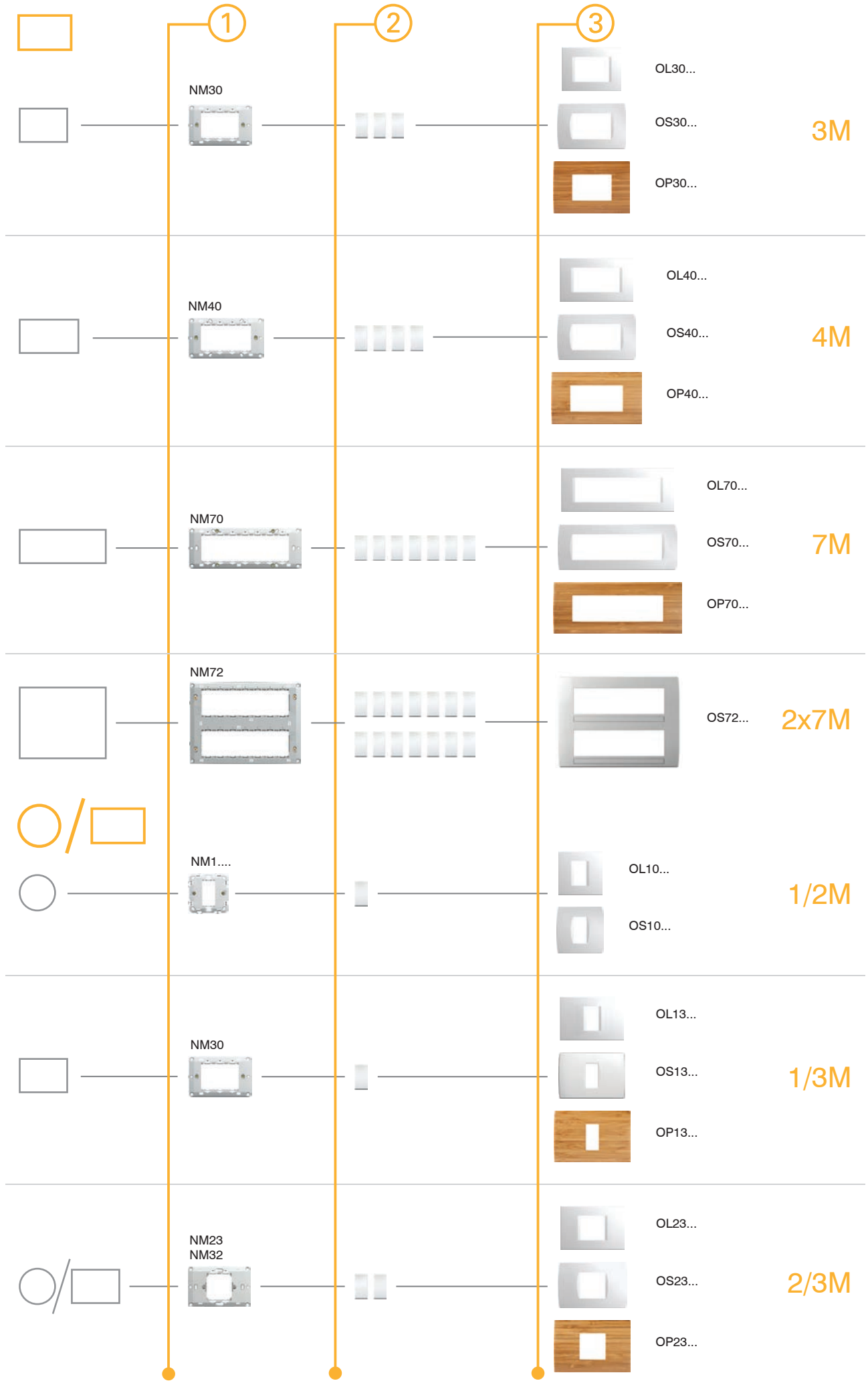

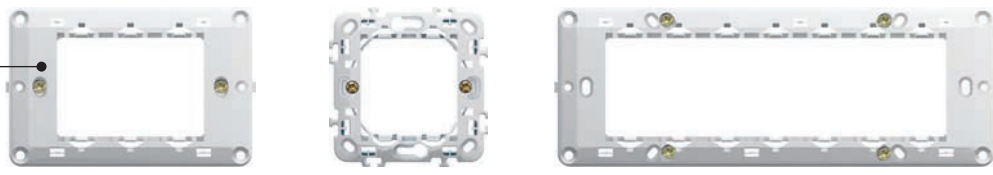

NM30

Typ type	Bezeichnung description	Größe size
NM10	MONTAGETRÄGER MIT KRALLEN MOUNTING FRAME WITH CLAWS	1/2M
NM11	MONTAGETRÄGER OHNE SCHRAUBEN MOUNTING FRAME WITHOUT SCREWS	1/2M
NM20	MONTAGETRÄGER MIT KRALLEN MOUNTING FRAME WITH CLAWS	2M
.	.	.
.	.	.



MONTAGETRÄGER MIT KRALLEN 2M



NM20

- Montageträger 2M mit Krallen
- Montage in der Wanddose Ø60 (DE..) mit Krallen
- Ermöglicht Steckmontage 2x2M, 3x2M und 4x2M in Horizontal- bzw. Vertikalrichtung
- geeignet für Rahmen LINE und SOFT
- entspricht EN 60669-1

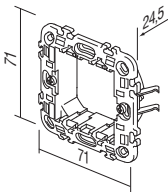

MOUNTING FRAME WITH CLAWS 2M

- mounting frame 2M with claws
- for mounting on boxes Ø60 (DE..) with claws
- possible horizontal or vertical combinations 2x2M, 3x2M and 4x2M
- suitable for assembling with cover plates LINE and SOFT
- in accordance with EN 60669-1

MONTAGETRÄGER OHNE SCHRAUBEN 2M



NM21

- Montageträger 2M ohne Schrauben bzw. Krallen
- Montage in der Wanddose Ø60 (HE.., BE..) mit Schrauben
- Ermöglicht Steckmontage 2x2M, 3x2M und 4x2M in Horizontal- bzw. Vertikalrichtung
- geeignet für Rahmen LINE und SOFT
- entspricht EN 60669-1

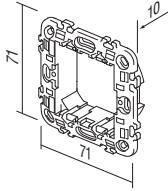

MOUNTING FRAME WITHOUT SCREWS 2M

- mounting frame 2M without screws and without claws
- for mounting on boxes Ø60 (HE.., BE..) with screws
- possible horizontal or vertical combinations 2x2M, 3x2M and 4x2M
- suitable for assembling with cover plates LINE and SOFT
- in accordance with EN 60669-1

MONTAGETRÄGER METALL MIT KRALLEN 2M

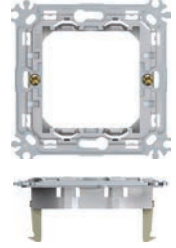

NM24

- Montageträger 2M aus Metall mit Krallen – steife Ausführung
- Montage in der Wanddose Ø60 (DE..) mit Krallen
- Ermöglicht Steckmontage 2x2M, 3x2M und 4x2M in Horizontal- bzw. Vertikalrichtung
- geeignet für Rahmen PURE, LINE und SOFT
- entspricht EN 60669-1

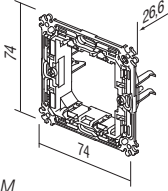

MOUNTING FRAME METAL WITH CLAWS 2M

- metal mounting frame 2M with claws - stiff version
- for mounting on boxes Ø60 (DE..) with claws
- possible horizontal or vertical combinations 2x2M, 3x2M and 4x2M
- suitable for assembling with cover plates PURE, LINE and SOFT
- in accordance with EN 60669-1

MONTAGETRÄGER METALL OHNE SCHRAUBEN 2M

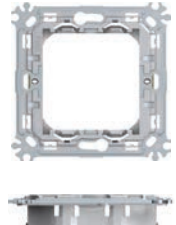

NM25

- Montageträger 2M aus Metall ohne Schrauben bzw. Krallen – steife Ausführung
- Montage in der Wanddose Ø60 (HE.., BE..) mit Krallen
- Ermöglicht Steckmontage 2x2M, 3x2M und 4x2M in Horizontal- bzw. Vertikalrichtung
- geeignet für Rahmen PURE, LINE und SOFT
- entspricht EN 60669-1

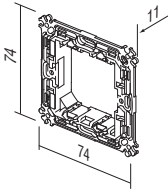

MOUNTING FRAME METAL WITHOUT SCREWS 2M

- metal mounting frame 2M without screws and without claws - stiff version
- for mounting on boxes Ø60 (HE.., BE..) with claws
- possible horizontal or vertical combinations 2x2M, 3x2M and 4x2M
- suitable for assembling with cover plates PURE, LINE and SOFT
- in accordance with EN 60669-1

M O U N T I N G F R A M E S N M



NM30

MONTAGETRÄGER MIT SCHRAUBEN 3M

- Montagetträger 3M mit Schrauben
- Montage in Rechteckdosen 3M
- geeignet für Rahmen PURE, LINE und SOFT
- entspricht EN 60669-1

MOUNTING FRAME WITH SCREWS 3M

- mounting frame 3M with screws
- for mounting on rectangular boxes 3M
- suitable for assembling with cover plates PURE, LINE and SOFT
- in accordance with EN 60669-1

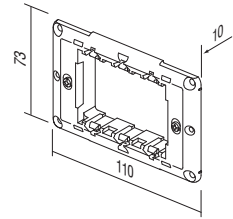

NM40

MONTAGETRÄGER MIT SCHRAUBEN 4M

- Montagetträger 4M mit Schrauben
- Montage in Rechteckdosen 4M
- geeignet für Rahmen PURE, LINE und SOFT
- entspricht EN 60669-1

MOUNTING FRAME WITH SCREWS 4M

- mounting frame 4M with screws
- for mounting on rectangular boxes 4M
- suitable for assembling with cover plates PURE, LINE and SOFT
- in accordance with EN 60669-1

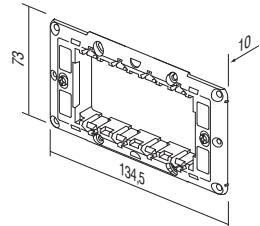

NM70

MONTAGETRÄGER MIT SCHRAUBEN 7M

- Montagetträger 7M mit Schrauben
- Montage in Rechteckdosen 7M
- geeignet für Rahmen PURE, LINE und SOFT
- entspricht EN 60669-1

MOUNTING FRAME WITH SCREWS 7M

- mounting frame 7M with screws
- for mounting on rectangular boxes 7M
- suitable for assembling with cover plates PURE, LINE and SOFT
- in accordance with EN 60669-1

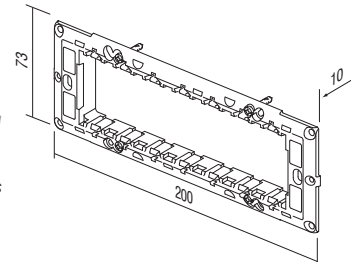

NM72

MONTAGETRÄGER MIT SCHRAUBEN 2x7M

- Montagetträger 2x7M mit Schrauben
- Montage in Rechteckdosen 2x7M
- geeignet für Rahmen SOFT OS72
- entspricht EN 60669-1

MOUNTING FRAME WITH SCREWS 2x7M

- mounting frame 2x7M with screws
- for mounting on rectangular boxes 2x7M
- suitable for assembling with cover plate SOFT OS72
- in accordance with EN 60669-1

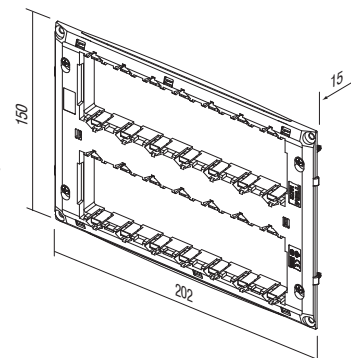



MONTAGETRÄGER MIT KRALLEN 1/2M



NM10

- Montageträger 1/2M mit Krallen
- Montage in der Wanddose Ø60 (DE..) mit Krallen
- geeignet für Rahmen LINE und SOFT
- entspricht EN 60669-1

MOUNTING FRAME WITH CLAWS 1/2M

- mounting frame 1/2M with claws
- for mounting on boxes Ø60 (DE..) with claws
- suitable for assembling with cover plates LINE and SOFT
- in accordance with EN 60669-1

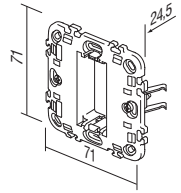

MONTAGETRÄGER OHNE SCHRAUBEN 1/2M



NM11

- Montageträger 1/2M ohne Schrauben bzw. Krallen
- Montage in der Wanddose Ø60 (HE..., BE..) mit Schrauben
- geeignet für Rahmen LINE und SOFT
- entspricht EN 60669-1

MOUNTING FRAME WITHOUT SCREWS 1/2M

- mounting frame 1/2M without screws and without claws
- for mounting on boxes Ø60 (HE..., BE..) with screws
- suitable for assembling with cover plates LINE and SOFT
- in accordance with EN 60669-1

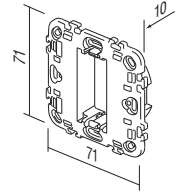

MONTAGETRÄGER MIT KRALLEN 2/3M

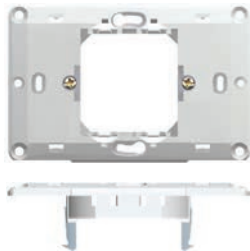

NM23

- Montageträger 2/3M mit Krallen
- Montage in der Wanddose Ø60 (DE..) mit Krallen
- geeignet für Rahmen PURE, LINE und SOFT
- entspricht EN 60669-1

MOUNTING FRAME WITH CLAWS 2/3M

- mounting frame 2/3M with claws
- for mounting on boxes Ø60 (DE..) with claws
- suitable for assembling with cover plates PURE, LINE and SOFT
- in accordance with EN 60669-1

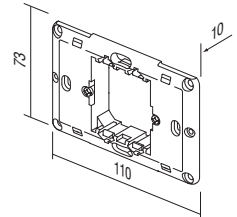

MONTAGETRÄGER MIT SCHRAUBEN 2/3M

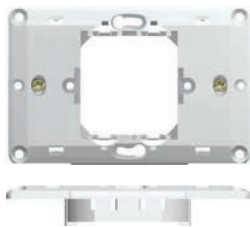

NM32

- Montageträger 2/3M mit Schrauben
- Montage in Rechteckdosen 3M
- geeignet für Rahmen PURE, LINE und SOFT
- entspricht EN 60669-1

MOUNTING FRAME WITH SCREWS 2/3M

- mounting frame 2/3M with screws
- for mounting on rectangular boxes 3M
- suitable for assembling with cover plates PURE, LINE and SOFT
- in accordance with EN 60669-1

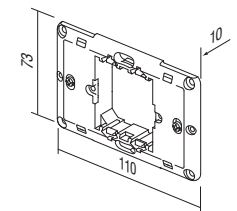

TEM

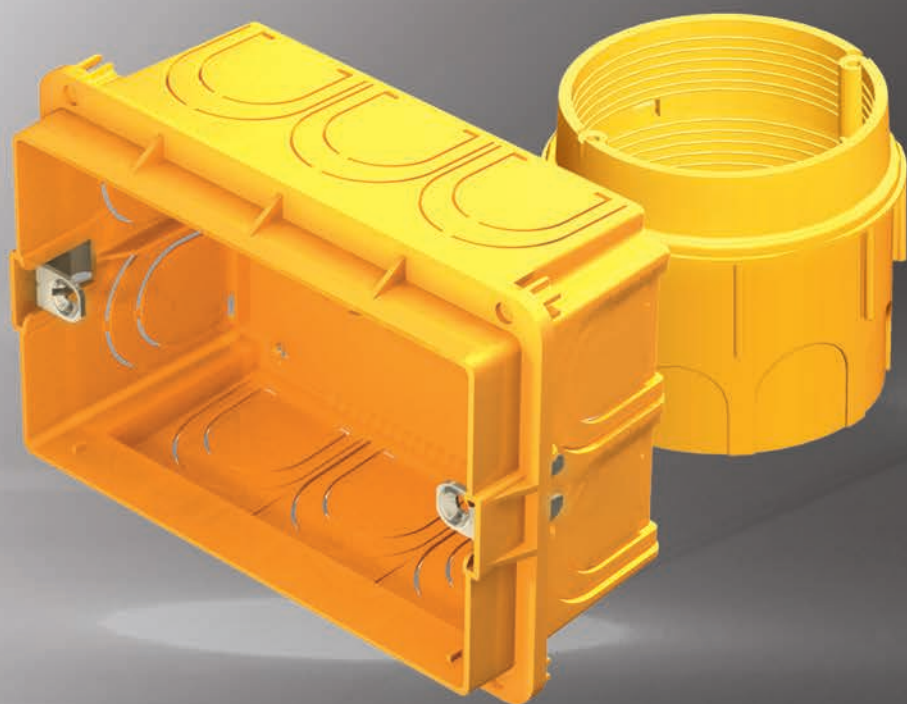

KATALOG / CATALOGUE

D O S E N



RUNDDOSEN
ROUND BOXES

118

RECHTECKDOSEN
RECTANGULAR BOXES



126

ABZWEIGKASTEN
JUNCTION BOXES

134

VERDRAHTUNGSZUBEHÖR
WIRING ACCESSORIES

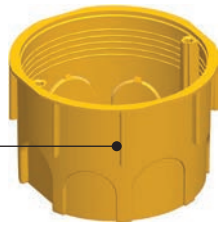
136



DE12



HE11



BE10

Typ type	Bezeichnung description	Größe size
DE10	RUNDDOSE ZIEGELWAND ROUND BOX BRICK	SM60-01
HE10	RUNDDOSE HOHLWAND ROUND BOX HOLLOW WALL	SM68X40
BE10	RUNDDOSE BETONWAND ROUND BOX CONCRETE	
.	.	.

RUNDDOSE ZIEGELWAND SM60-01



DE10

- Durchmesser Ø60 mm, Tiefe 40 mm
- 650°C, 500V~
- entspricht IEC 60670-1
- ohne Halogen

ROUND BOX BRICK SM60-01

- Ø60, depth 40mm
- 650°C, 500V~
- in accordance with IEC 60670-1
- halogen free

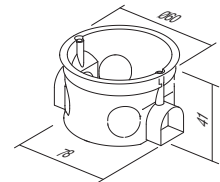

RUNDDOSE ZIEGELWAND TIEF SM60-06



DE11

- Durchmesser Ø60 mm, Tiefe 60mm
- 650°C, 500V~
- entspricht IEC 60670-1
- ohne Halogen

ROUND BOX BRICK DEEP SM60-06

- Ø60, depth 60mm
- 650°C, 500V~
- in accordance with IEC 60670-1
- halogen free

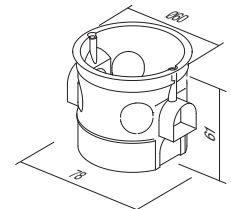

ABSTANDSTUTZEN SM60-03



DE30

- für vertikale Mehrfachkombinationen von Dosen SM60-06 bzw. SM60-01 auf einer Distanz von 91 mm
- entspricht IEC 60670-1
- ohne Halogen

COMBI-CLIP SM60-03

- for vertical fitting of boxes SM60-06 or SM60-01 on distance 91 mm
- in accordance with IEC 60670-1
- halogen free

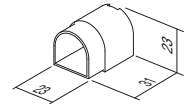

ABSTANDSTUTZEN SM60-04











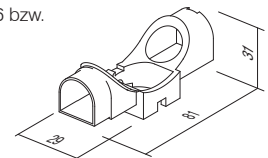



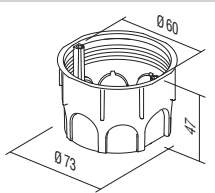

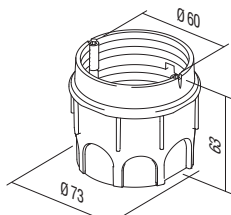

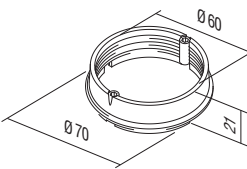
DE31

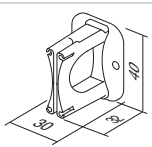
- für horizontale Mehrfachkombinationen von Dosen SM60-06 bzw. SM60-01 auf einer Distanz von 71mm
- entspricht IEC 60670-1
- ohne Halogen

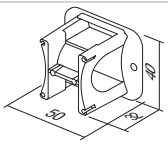
COMBI-CLIP SM60-04

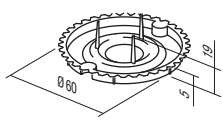
- for horizontal fitting of boxes SM60-06 or SM60-01 on distance 71mm
- in accordance with IEC 60670-1
- halogen free

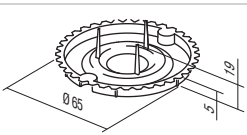

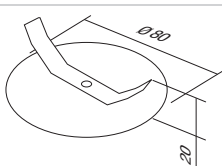
	DE12	RUNDDOSE ZIEGELWAND MD65-46 - Durchmesser Ø60 mm, Tiefe 46 mm - 650°C, 500V~ - entspricht IEC 60670-1 ROUND BOX BRICK MD65-46 - Ø65, depth 46mm - 650°C, 500V~ - in accordance with IEC 60670-1	
	DE13	RUNDDOSE ZIEGELWAND TIEF MD65-60 - Durchmesser Ø65/60 mm, Tiefe 62 mm - 650°C, 500V~ - entspricht IEC 60670-1 ROUND BOX BRICK DEEP MD65-60 - Ø65/60, depth 62mm - 650°C, 500V~ - in accordance with IEC 60670-1	
	DE14	VERLÄNGERUNG FÜR RUNDDOSE ZIEGELWAND MD65-46 - Durchmesser Ø65/60 mm, Tiefe 17 mm - 650°C, 500V~ - entspricht IEC 60670-1 ADDITIONAL PIECE FOR MD65-46 - Ø65/60, depth 17mm - 650°C, 500V~ - in accordance with IEC 60670-1	
	DE32	ABSTANDSTUTZEN MD65-71 - für Verbindung von Dosen MD65 auf eine Distanz von 71 mm - entspricht IEC 60670-1 COMBI-CLIP MD65-71 - for fitting of boxes MD65 on distance 71 mm - in accordance with IEC 60670-1	
	DE33	ABSTANDSTUTZEN MD65-91 - für Verbindung von Dosen MD65 auf eine Distanz von 91mm - entspricht IEC 60670-1 COMBI-CLIP MD65-91 - for fitting of boxes MD65 on distance 91mm - in accordance with IEC 60670-1	
	DE20	FEDERDECKEL 60 - Federdeckel für Runddosen Ø60 für DE13, DE14 - entspricht IEC 60670-1 - zum Schutz beim Verputzen BOX COVER PROTECTIVE 60 - protective cover for box Ø60 for DE13, DE14 - in accordance with IEC 60670-1 - box protection during plastering	
	DE21	FEDERDECKEL 65 - Federdeckel für Runddosen Ø65 für DE12 - entspricht IEC 60670-1 - zum Schutz beim Verputzen BOX COVER PROTECTIVE 65 - protective cover for box Ø65 for DE12 - in accordance with IEC 60670-1 - box protection during plastering	
	DE22	ABDECKUNG DEKORATIV SM60 - dekorative Abdeckung für Runddosen Ø60 - entspricht IEC 60670-1 - ohne Halogen BOX COVER DECORATIVE SM60 - decorative cover for boxes Ø60 - in accordance with IEC 60670-1 - halogen free	



Montageanleitung /
assembly instructions

Abstand unter Dosen / distance between boxes: 71mm

Abstand unter Dosen / distance between boxes: 91mm

D O S E N

DE10,11

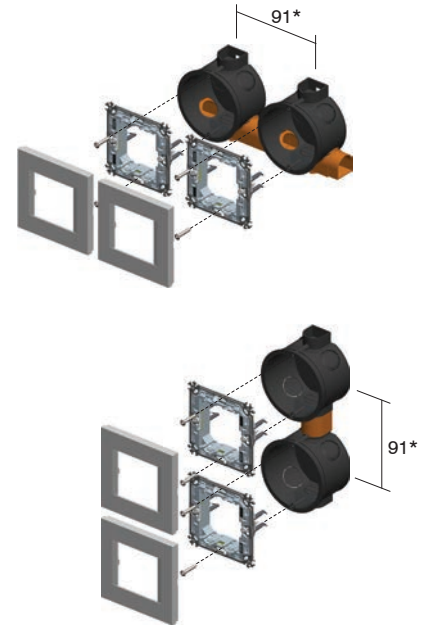
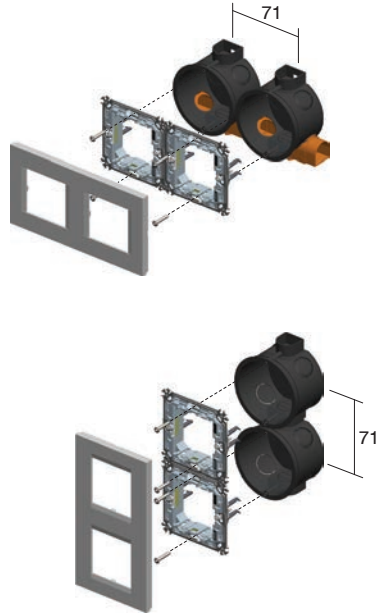
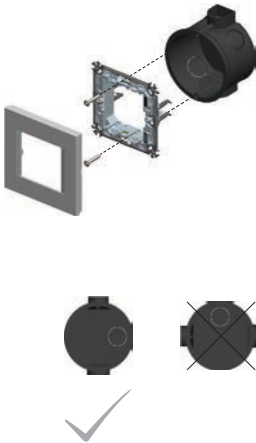

DE12,13

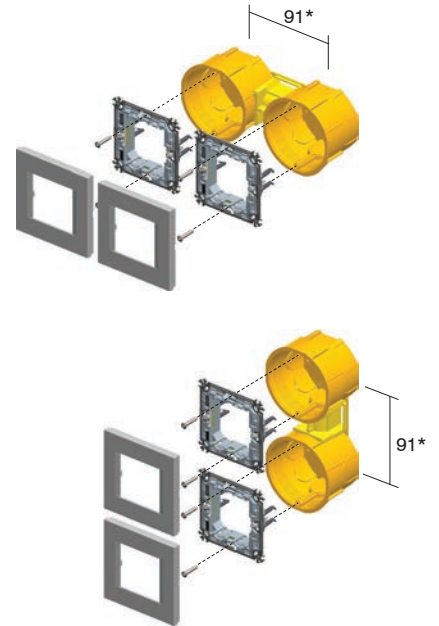
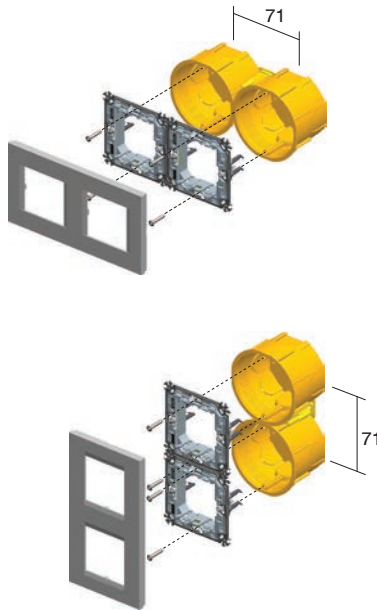
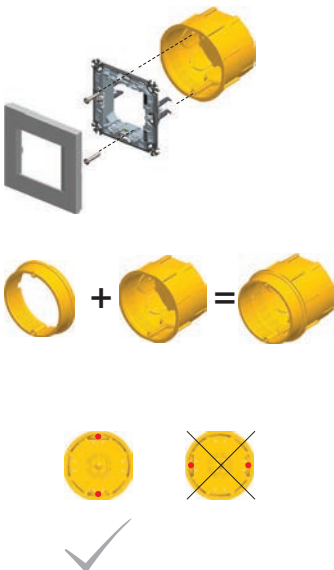

* für Rahmen PURE beträgt der Abstand zwischen Dosen 100 mm

* for PURE cover plates the minimum distance between boxes is 100mm

R O U N D B O X E S



DE10,11



DE12,13



NM20



NM24



DE10,11



DE12,13



NM10



DE10,11



DE12,13



NM23



71

2xDE10,11 + 2xDE31



2xDE12,13 + 1xDE32



2xNM20



2xNM24



2xDE10,11 2xDE12,13 + 1xDE32



2xNM20



2xNM24



3xDE10,11 + 3xDE31



3xDE12,13 + 2xDE32



3xNM20



3xNM24



3xDE10,11 3xDE12,13 + 2xDE32

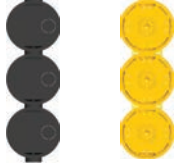

3xNM20

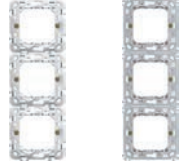

3xNM24



4xDE10,11 + 4xDE31



4xDE12,13 + 3xDE32



4xNM20



4xNM24



4xDE10,11 4xDE12,13 + 3xDE32

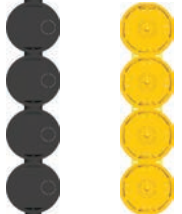

4xNM20

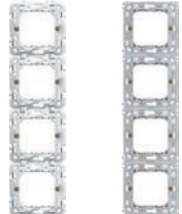

4xNM24



RUNDDOSE HOHLWAND SM68x40



HE10

- Durchmesser Ø60 mm, Tiefe 40 mm
- Einbauloch Ø68
- 850°C, 400V~
- entspricht IEC 60670-1
- Montage mit Krallen
- ohne Halogen

ROUND BOX HOLLOW WALL SM68x40

- Ø60, depth 40mm
- cutting hole Ø68
- 850°C, 400V~
- in accordance with IEC 60670-1
- mounting with claws
- halogen free

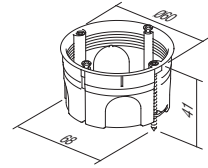

RUNDDOSE HOHLWAND SM68x55



HE11

- Durchmesser Ø60 mm, Tiefe 55 mm
- Einbauloch Ø68
- 850°C, 400V~
- entspricht IEC 60670-1
- Montage mit Krallen
- ohne Halogen

ROUND BOX HOLLOW WALL SM68x55

- Ø60, depth 55mm
- cutting hole Ø68
- 850°C, 400V~
- in accordance with IEC 60670-1
- mounting with claws
- halogen free

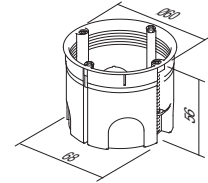

RUNDDOSE BETONWAND

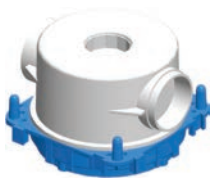

BE10

- Durchmesser Ø60 mm, Tiefe 49 mm
- 650°C, 500V~
- entspricht IEC 60670-1

ROUND BOX CONCRETE

- Ø60mm, depth 49mm
- 650°C, 500V~
- in accordance with IEC 60670-1

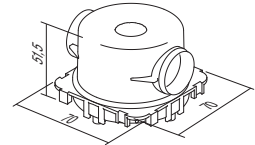

RUNDDOSE BETONWAND TIEF



BE11

- Durchmesser Ø60 mm, Tiefe 58 mm
- 650°C, 500V~
- entspricht IEC 60670-1

ROUND BOX CONCRETE DEEP

- Ø60mm, depth 58mm
- 650°C, 500V~
- in accordance with IEC 60670-1

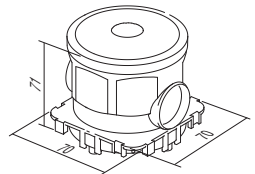

GEGENLAGER FÜR RUNDDOSE BETONWAND



BE20

- bei extremer Belastung wird die Dose zusätzlich durch ein Distanzprofil BM82 in Gegenwand abgestützt
- entspricht IEC 60670-1

COUNTER BOX SUPPORT CONCRETE

- to support concrete boxes with distance profile BM82 for extreme loads
- in accordance with IEC 60670-1

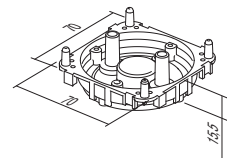

ROHREINFÜHRUNG 16 FÜR RUNDDOSE BETONWAND



BE21

- für Rohrfixierung auch bei größeren Belastungen
- entspricht IEC 60670-1

PIPE STOPPER CONCRETE BOX 16

- for firming installation pipe to box
- in accordance with IEC 60670-1

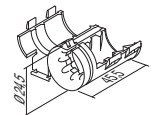

R O U N D B O X E S

Hohlwand / hollow walls



Betonwand / concrete



Montageanleitung /
assembly instructions

Abstand unter Dosen / distance between boxes: 71mm

Abstand unter Dosen / distance between boxes: 91mm

HE10,11

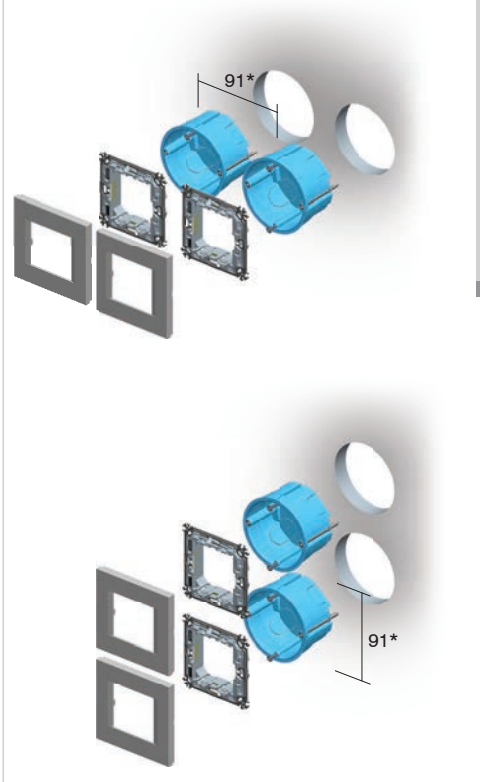
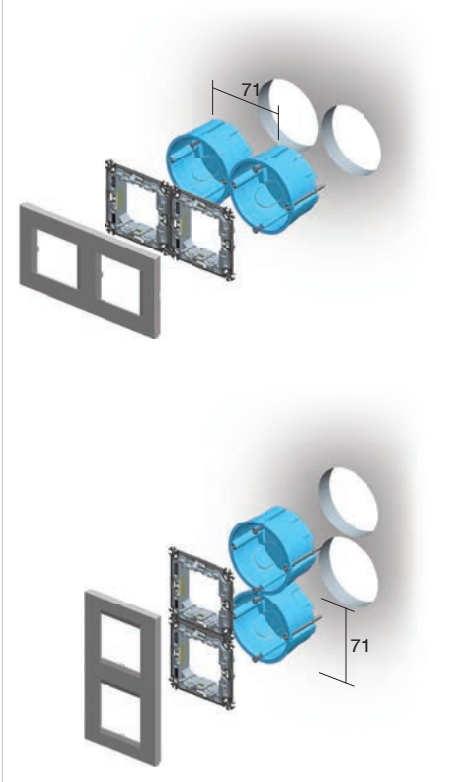
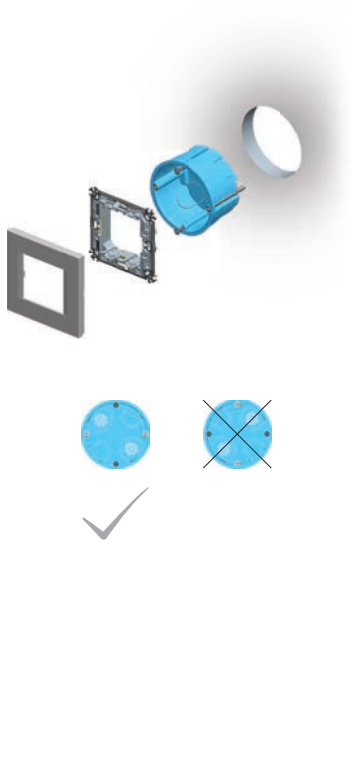

BE10

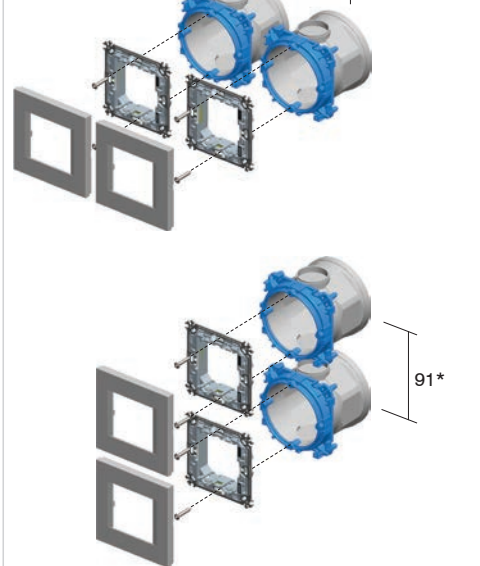
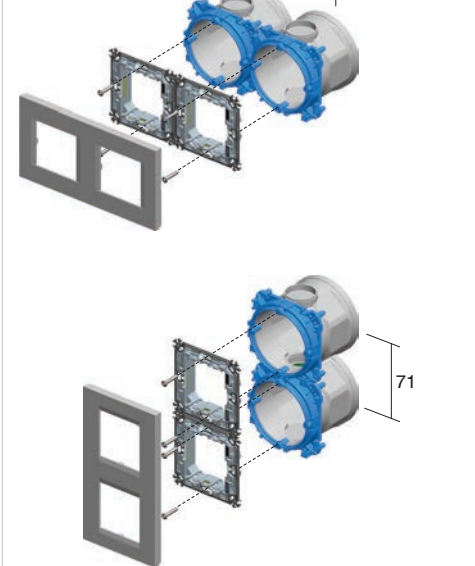
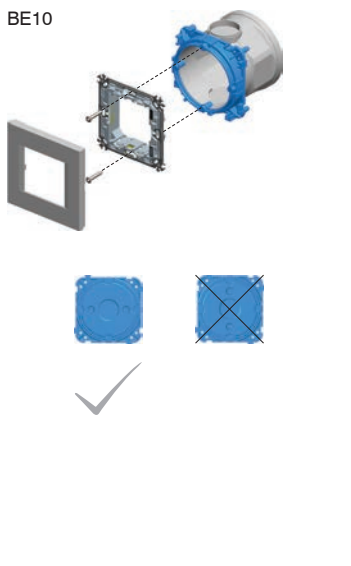

* für Rahmen PURE beträgt der Abstand zwischen Dosen 100 mm

* for PURE cover plates the minimum distance between boxes is 100mm

Hohlwand / hollow walls



Betonwand / concrete



HE10,11



BE10,11



NM21



NM25



2M

HE10,11



BE10,11



NM11



1/2M

2xHE10,11



2xBE10,11



2xNM21



2xNM25



2x2M

HE10,11



BE10,11



NM32



2/3M

2xHE10,11



2xBE10,11



2xNM21



2xNM25



3xHE10,11



3xBE10,11



3xNM21



3xNM25



3x2M

3xHE10,11



3xBE10,11



3xNM21



3xNM25



4xHE10,11



4xBE10,11



4xNM21



4xNM25



4x2M

4xHE10,11



4xBE10,11



4xNM21



4xNM25



R O U N D B O X E S

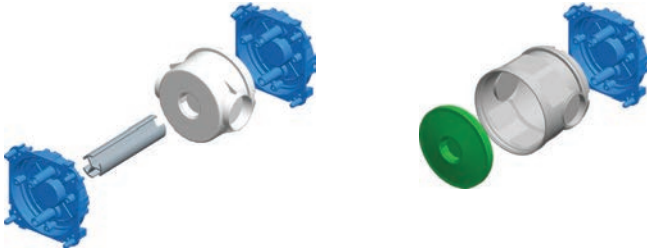

Montageanleitung /
assembly instructions

1

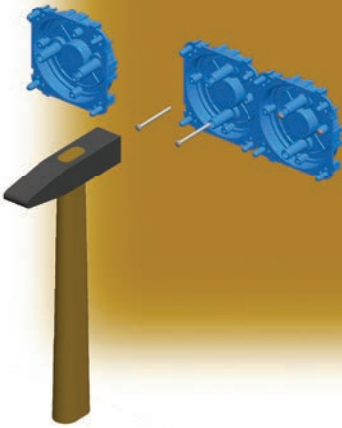

2

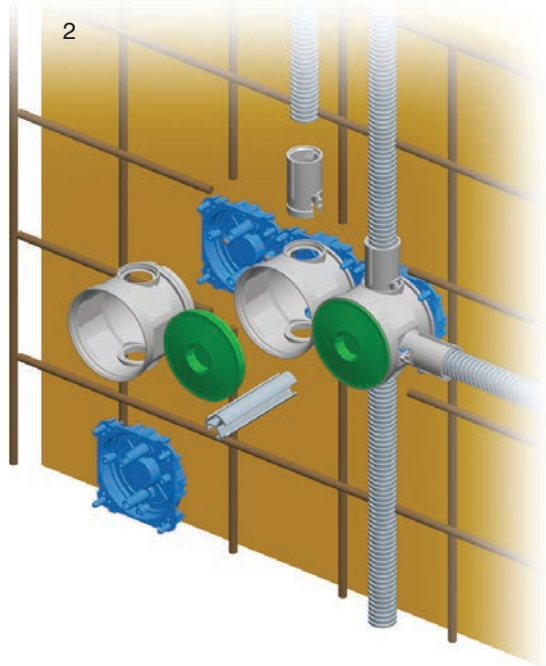

3

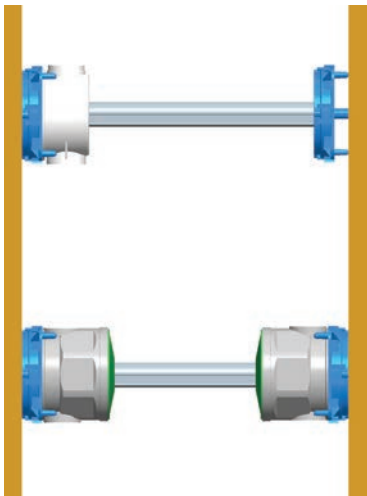

4

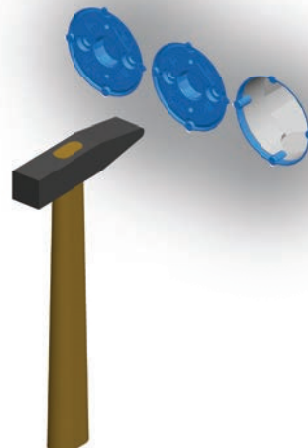

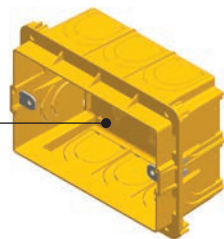

DM30



HM30

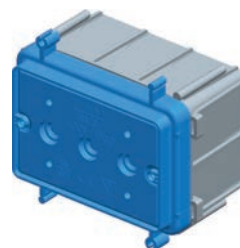

BM30

Typ type	Bezeichnung description	Größe size
DM30	RECHTECKDOSE ZIEGELWAND <i>RECTANGULAR BOX BRICK</i>	PM3
HM30	RECHTECKDOSE HOHLWAND <i>RECTANGULAR BOX HOLLOW WALL</i>	VM3
BM30	RECHTECKDOSE BETONWAND <i>RECTANGULAR BOX CONCRETE</i>	BM3
.	.	.
.	.	.

RECHTECKDOSE ZIEGELWAND PM3



DM30

- Breite 3M, Tiefe 49 mm
- 650°C, 400V~
- entspricht IEC 60670-1
- ohne Halogen

RECTANGULAR BOX BRICK PM3

- size 3M, depth 49mm
- 650°C, 400V~
- in accordance with IEC 60670-1
- halogen free

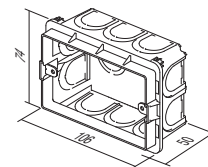

RECHTECKDOSE ZIEGELWAND PM3-65

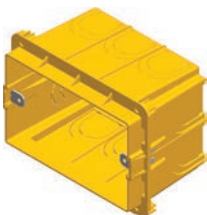

DM31

- Breite 3M, Tiefe 65 mm
- 650°C, 400V~
- entspricht IEC 60670-1
- ohne Halogen

RECTANGULAR BOX BRICK PM3-65

- size 3M, depth 65mm
- 650°C, 400V~
- in accordance with IEC 60670-1
- halogen free

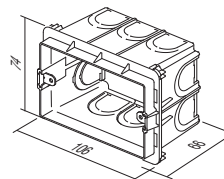

RECHTECKDOSE ZIEGELWAND PM4



DM40

- Breite 4M, Tiefe 49 mm
- 650°C, 400V~
- entspricht IEC 60670-1
- ohne Halogen

RECTANGULAR BOX BRICK PM4

- size 4M, depth 49mm
- 650°C, 400V~
- in accordance with IEC 60670-1
- halogen free

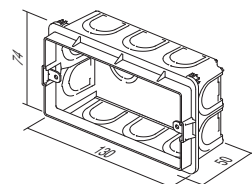

RECHTECKDOSE ZIEGELWAND PM4-65



DM41

- Breite 4M, Tiefe 65 mm
- 650°C, 400V~
- entspricht IEC 60670-1
- ohne Halogen

RECTANGULAR BOX BRICK PM4-65

- size 4M, depth 65mm
- 650°C, 400V~
- in accordance with IEC 60670-1
- halogen free

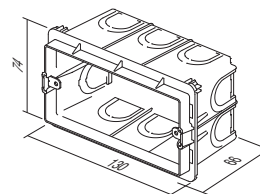

RECHTECKDOSE ZIEGELWAND PM7

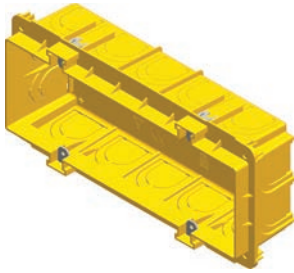

DM70

- Breite 7M, Tiefe 49 mm
- 650°C, 400V~
- entspricht IEC 60670-1
- ohne Halogen

RECTANGULAR BOX BRICK PM7

- size 7M, depth 49mm
- 650°C, 400V~
- in accordance with IEC 60670-1
- halogen free

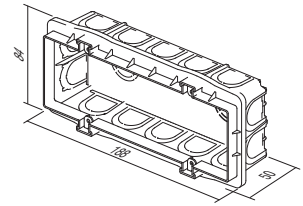

RECHTECKDOSE ZIEGELWAND PM7-65

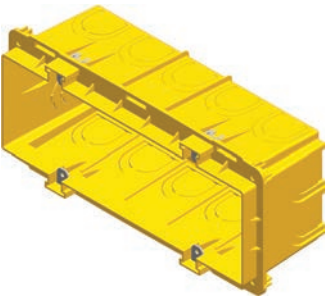

DM71

- Breite 7M, Tiefe 65 mm
- 650°C, 400V~
- entspricht IEC 60670-1
- ohne Halogen

RECTANGULAR BOX BRICK PM7-65

- size 7M, depth 65mm
- 650°C, 400V~
- in accordance with IEC 60670-1
- halogen free

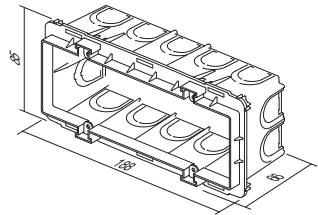

RECHTECKDOSE ZIEGELWAND PM72-65



DM72

- Breite 2x7M, Tiefe 64 mm
- 650°C, 400V~
- entspricht IEC 60670-1

RECTANGULAR BOX BRICK PM72-65

- size 2x7M, depth 64mm
- 650°C, 400V~
- in accordance with IEC 60670-1

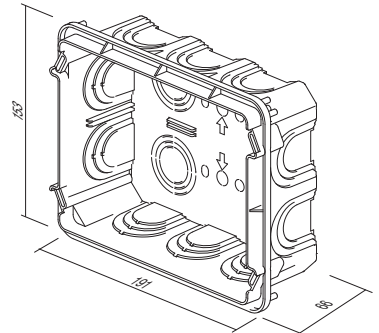

ABSTANDHALTER FÜR RECHTECKDOSEN PM

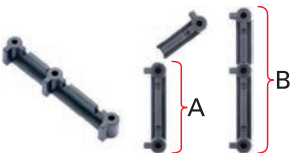

DM80

- ermöglicht Vertikal- (B) und Horizontalmontage (A) von mehreren Rechteckdosen PM3, PM4 und PM7 auf eine feste Distanz

DISTANCE PIECE FOR BOX PM

- for vertical (B) and horizontal (A) fitting of boxes PM3, PM4 and PM7

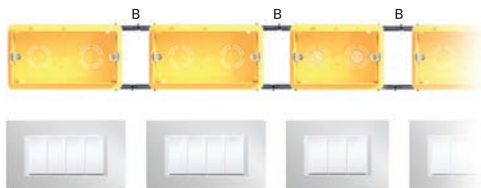
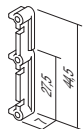



DM33

FEDERDECKEL PM3

- Federdeckel für Rechteckdosen PM3
- entspricht IEC 60670-1
- ohne Halogen
- zum Schutz beim Verputzen

BOX COVER PROTECTIVE PM3

- protective cover for box PM3
- in accordance with IEC 60670-1
- halogen free
- box protection during plastering

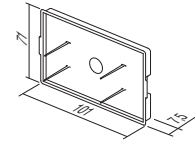

DM34

ABDECKUNG DEKORATIV PM3

- dekorative Abdeckung für Rechteckdosen 3M
- inkl. Schrauben
- entspricht IEC 60670-1
- ohne Halogen

BOX COVER DECORATIVE PM3

- decorative cover for boxes 3M
- screws are included
- in accordance with IEC 60670-1
- halogen free

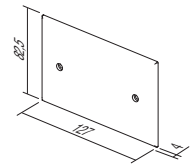

DM43

FEDERDECKEL PM4

- Federdeckel für Rechteckdosen PM4
- entspricht IEC 60670-1
- ohne Halogen
- zum Schutz beim Verputzen

BOX COVER PROTECTIVE PM4

- protective cover for box PM4
- in accordance with IEC 60670-1
- halogen free
- box protection during plastering

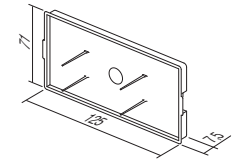

DM44

ABDECKUNG DEKORATIV PM4

- dekorative Abdeckung für Rechteckdosen 4M
- inkl. Schrauben
- entspricht IEC 60670-1
- ohne Halogen

BOX COVER DECORATIVE PM4

- decorative cover for boxes 4M
- screws are included
- in accordance with IEC 60670-1
- halogen free

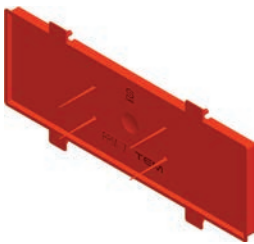
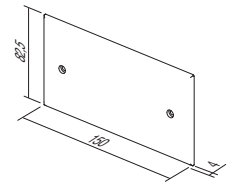

DM73

FEDERDECKEL PM7

- Federdeckel für Rechteckdosen PM7
- entspricht IEC 60670-1
- ohne Halogen
- zum Schutz beim Verputzen

BOX COVER PROTECTIVE PM7

- protective cover for box PM7
- in accordance with IEC 60670-1
- halogen free
- box protection during plastering

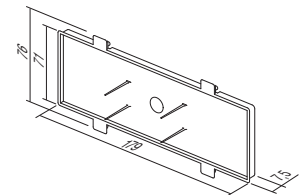

DM74

ABDECKUNG DEKORATIV PM7

- dekorative Abdeckung für Rechteckdosen 7M
- inkl. Schrauben
- entspricht IEC 60670-1
- ohne Halogen

BOX COVER DECORATIVE PM7

- decorative cover for boxes 7M
- screws are included
- in accordance with IEC 60670-1
- halogen free

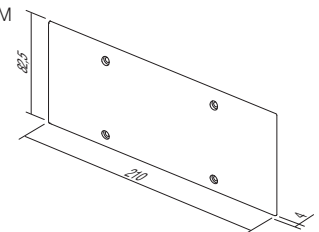



DM75

ABDECKUNG DEKORATIV PM72

- dekorative Abdeckung für Rechteckdosen 2x7M
- inkl. Schrauben
- entspricht IEC 60670-1

BOX COVER DECORATIVE PM72

- decorative cover for boxes 2x7M
- screws are included
- in accordance with IEC 60670-1

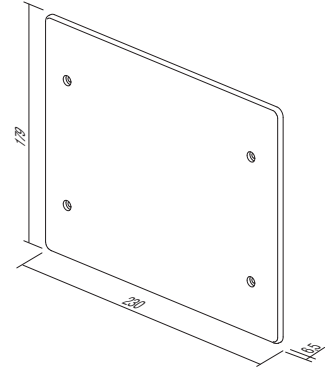



HM30

RECHTECKDOSE HOHLWAND VM3

- Breite 3M, Tiefe 49 mm
- Einbauloch 2xØ68/45 mm
- 850°C, 400V~
- entspricht IEC 60670-1
- ohne Halogen

RECTANGULAR BOX HOLLOW WALL VM3

- size 3M, depth 49mm
- cutting hole 2xØ68/45mm
- 850°C, 400V~
- in accordance with IEC 60670-1
- halogen free

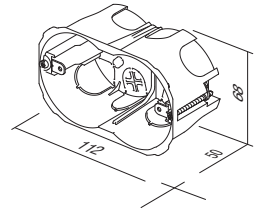

HM40

RECHTECKDOSE HOHLWAND VM4

- Breite 4M, Tiefe 49mm
- Einbauloch 2xØ68/70 mm
- 850°C, 400V~
- entspricht IEC 60670-1
- ohne Halogen

RECTANGULAR BOX HOLLOW WALL VM4

- size 4M, depth 49mm
- cutting hole 2xØ68/70mm
- 850°C, 400V~
- in accordance with IEC 60670-1
- halogen free

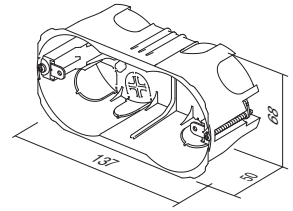

HM70

RECHTECKDOSE HOHLWAND VM7

- Breite 7M, Tiefe 49 mm
- Einbauloch 2xØ68/120 mm
- 850°C, 400V~
- entspricht IEC 60670-1
- ohne Halogen

RECTANGULAR BOX HOLLOW WALL VM7

- size 7M, depth 49mm
- cutting hole 2xØ68/120mm
- 850°C, 400V~
- in accordance with IEC 60670-1
- halogen free

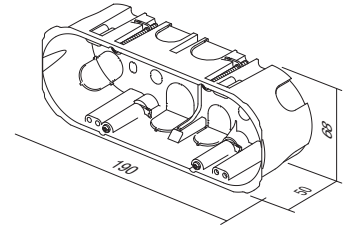

HM72



RECHTECKDOSE HOHLWAND VM72

- Breite 2x7M, Tiefe 63 mm
- 850°C, 400V~
- entspricht IEC 60670-1

RECTANGULAR BOX HOLLOW WALL VM72

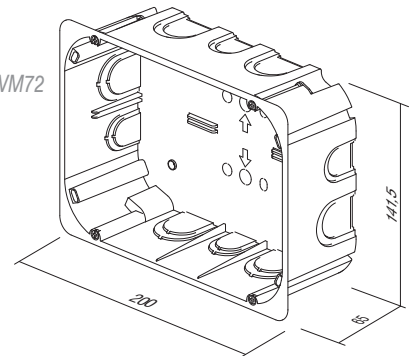
- size 2x7M, depth 63mm
- 850°C, 400V~
- in accordance with IEC 60670-1

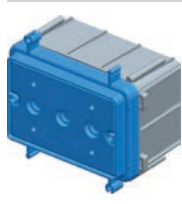
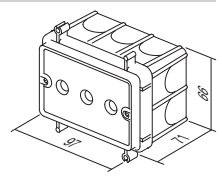
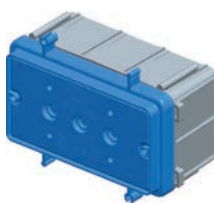
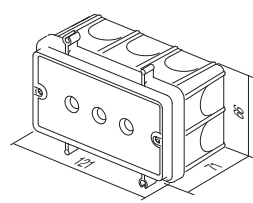
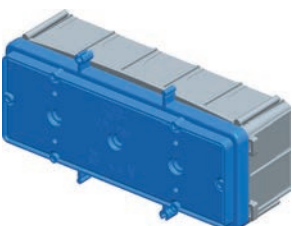
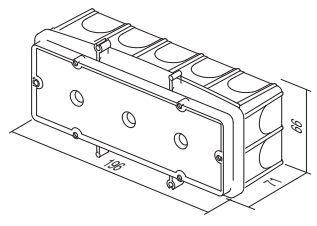

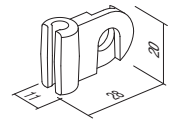
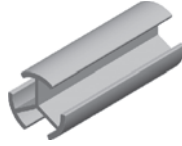
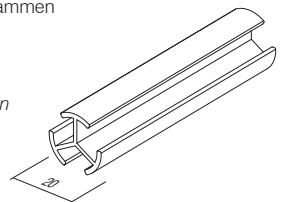
	BM30	<p>RECHTECKDOSE BETONWAND BM30</p> <ul style="list-style-type: none"> - Breite 3M, Tiefe 60 mm - 650°C, 400V~ - entspricht IEC 60670-1 <p><i>RECTANGULAR BOX CONCRETE BM30</i></p> <ul style="list-style-type: none"> - size 3M, depth 60mm - 650°C, 400V~ - in accordance with IEC 60670-1 	
	BM40	<p>RECHTECKDOSE BETONWAND BM40</p> <ul style="list-style-type: none"> - Breite 4M, Tiefe 60 mm - 650°C, 400V~ - entspricht IEC 60670-1 <p><i>RECTANGULAR BOX CONCRETE BM40</i></p> <ul style="list-style-type: none"> - size 4M, depth 60mm - 650°C, 400V~ - in accordance with IEC 60670-1 	
	BM70	<p>RECHTECKDOSE BETONWAND BM70</p> <ul style="list-style-type: none"> - Breite 7M, Tiefe 60 mm - 650°C, 400V~ - entspricht IEC 60670-1 <p><i>RECTANGULAR BOX CONCRETE BM70</i></p> <ul style="list-style-type: none"> - size 7M, depth 60mm - 650°C, 400V~ - in accordance with IEC 60670-1 	
	BM80	<p>BEFESTIGUNGSELEMENT FÜR DOSEN BM</p> <ul style="list-style-type: none"> - für schnelle Befestigung von Rechteckdosen BM auf die Bewehrung - geeignet für Stäbe bis Durchmesser Ø8 mm <p><i>FIXING COMBI-CLIP BM</i></p> <ul style="list-style-type: none"> - for fast fixation of BM rectangular boxes on reinforcing bar - suitable for bar diameter up to Ø8mm 	
	BM82	<p>DISTANZPROFIL FÜR DOSEN BM</p> <ul style="list-style-type: none"> - für die Abstützung von Rechteckdosen BM zusammen mit deren Träger in die Gegenwand - Länge l=1m, Durchmesser Ø20 mm <p><i>DISTANCE PROFIL FOR BOXES BM</i></p> <ul style="list-style-type: none"> - to support boxes BM with counter box support on opposite wall - length l=1m, diameter Ø20mm 	

R E C H T E C K D O S E N



Ziegelwand / brick



Hohlwand / hollow walls



Betonwand / concrete



D O S E N

DM30		 NM30	3M
HM30			
BM30			
DM40		 NM40	4M
HM40			
BM40			
DM70		 NM70	7M
HM70			
BM70			
DM72		 NM72	2x7M
HM72			
DM30		 NM32	2/3M
HM30			
BM30			

R E C T A N G U L A R B O X E S

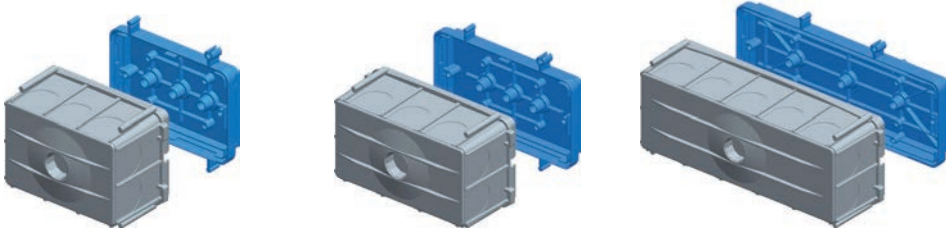

Montageanleitung /
assembly instructions

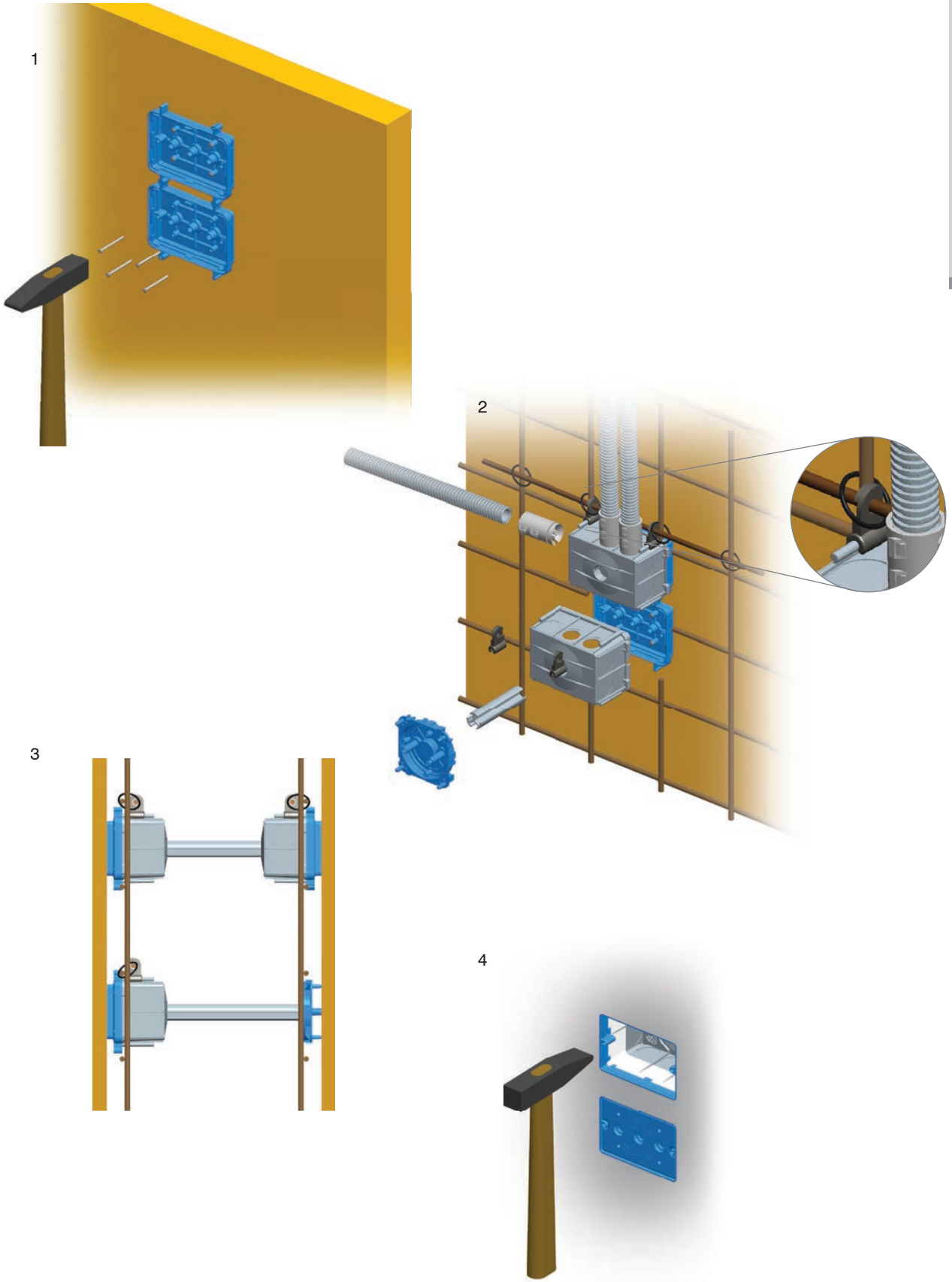

ABZWEIGDOSE RUND ZIEGELWAND DSM78



DW10

- Durchmesser Ø78 mm, Tiefe 40 mm
- 650°C, 500V~
- entspricht IEC 60670-1 und IEC 60670-22
- ohne Halogen

CONNECTION ROUND BOX BRICK DSM78

- Ø78, depth 40mm
- 650°C, 500V~
- in accordance with IEC 60670-1 and IEC 60670-22
- halogen free

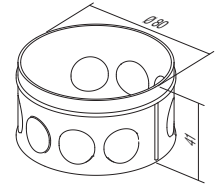

ABZWEIGDOSE RUND HOHLWAND SM78x45



HW10

- Durchmesser Ø78 mm, Tiefe 45 mm
- Einbauloch Ø80
- 850°C, 400V~
- entspricht IEC 60670-1 und IEC 60670-22
- Montage mit Krallen
- ohne Halogen

CONNECTION ROUND BOX HOLLOW WALL SM78x45

- Ø78, depth 45mm
- cutting hole Ø80
- 850°C, 400V~
- in accordance with IEC 60670-1 and IEC 60670-22
- mounting with claws
- halogen free

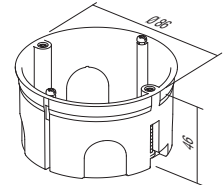

ABDECKUNG DEKORATIV SM78



DE23

- dekorative Abdeckung für Dosen Ø78
- entspricht IEC 60670-1 und IEC 60670-22
- ohne Halogen

BOX COVER DECORATIVE SM78

- decorative cover for boxes Ø78
- in accordance with IEC 60670-1 and IEC 60670-22
- halogen free

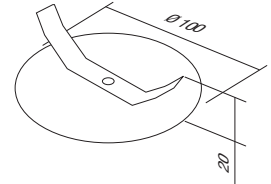

FEDERDECKEL 78



DE24

- Federdeckel für Dosen Ø78
- entspricht IEC 60670-1 und IEC 60670-22
- ohne Halogen

BOX COVER PROTECTIVE 78

- protective cover for box Ø78
- in accordance with IEC 60670-1 and IEC 60670-22
- halogen free

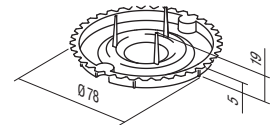

ABZWEIGKASTEN ZIEGELWAND SM105x105



HW20

- 105x105 mm, Tiefe 50 mm
- Einbauloch gemäß beigelegter Lehre
- 850°C, 400V~
- entspricht IEC 60670-1 und IEC 60670-22
- Montage mit Krallen
- ohne Halogen

CONNECTION SQUARE BOX BRICK SM105x105

- size 105x105mm, depth 50mm
- cutting hole according to attached template
- 850°C, 400V~
- in accordance with IEC 60670-1 and IEC 60670-22
- mounting with claws
- halogen free

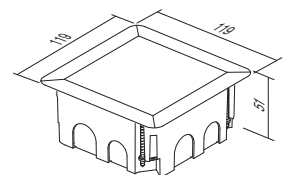

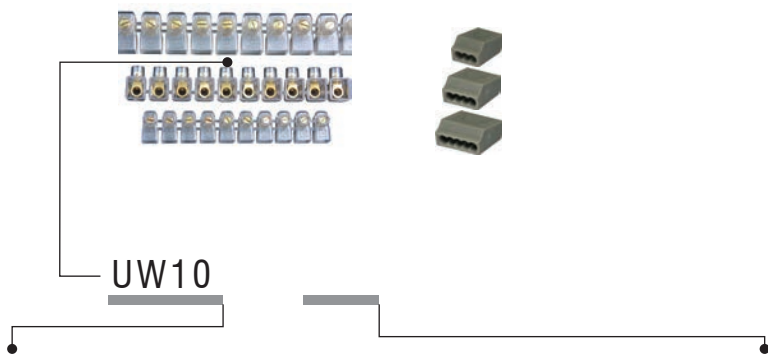

Typ type	Bezeichnung description	Technische daten technical data	Größe size	Farbe colour
UW10	DOSENKLEMMLEISTEN 1 ROW TERMINAL BLOCKS	2x2.5mm ²	10P	TS Transparent transparent
UW11	DOSENKLEMMLEISTEN 1 ROW TERMINAL BLOCKS	2x4mm ²	10P	CO Farbig colour
UW12	DOSENKLEMMLEISTEN 1 ROW TERMINAL BLOCKS	2x6mm ²	10P	WH Weiß white
.	.	.	.	GY Grau grey

DOSENKLEMMLEISTEN



- 450V~; 2x2,5 mm² ÷ 2x6 mm²
- Thermoplast PC, transparent
- Klemmen in Leiste: 10

1 ROW TERMINAL BLOCKS CLOSED

- 450V~; 2x2,5mm² ÷ 2x6mm²
- thermoplast PC, transparent
- number of poles: 10

UW10TS	(NS12)	2x2.5mm ²	10P
UW11TS	(NS12)	2x4mm ²	10P
UW12TS	(NS12)	2x6mm ²	10P

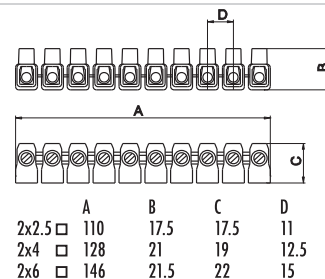

DOSENKLEMMLEISTEN



- 450V~; 2x2,5 mm² ÷ 2x6 mm²
- Thermoplast PA
- in verschiedenen farben erhältlich
- Klemmen in Leiste: 12

1 ROW TERMINAL BLOCKS

- 450V~; 2x2,5mm² ÷ 2x6mm²
- thermoplast PA
- available in different colours
- number of poles: 12

UW15CO	(NS12)	2x2.5mm ²	12P
UW16CO	(NS12)	2x4mm ²	12P
UW17CO	(NS12)	2x6mm ²	12P

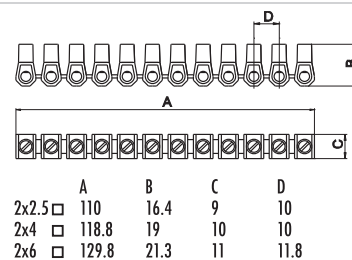

LÜSTER-KLEMMLEISTEN

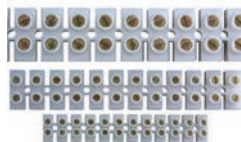

- 450V~; 1,5 mm² ÷ 16 mm²
- Thermoplast PA, weiß
- Klemmen in Leiste: 12

2 ROW TERMINAL BLOCKS

- 450V~; 1,5mm² ÷ 16mm²
- thermoplast PA, white
- number of poles: 12

UW20WH	(P7)	2.5-4.0mm ²	12P
UW21WH	(P9)	4.0-6.0mm ²	12P
UW22WH	(P12)	6.0-10mm ²	12P
UW23WH	(P14)	16mm ²	12P

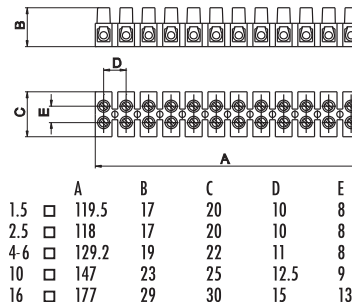

STECKKLEMMEN

- 24A 450V~, Thermoplast PA, grau
- Klemmen in Leiste: 3÷8
- Steckklemmen 0,5 ÷ 1,5 mm², für harte Drähte
- entspricht EN 60998-1

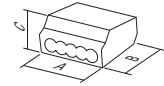
**PLUG-IN WIRE CONNECTORS**

- 24A 450V~, thermoplast PA, grey
- number of poles: 3÷8
- plug-in contacts 0.5÷1.5mm², for rigid wires
- in accordance with EN 60998-1

					A	B	C
UW40GY	PC153	1.5mm ²	3P	3P	12	18	9
UW41GY	PC155	1.5mm ²	5P	5P	17	18	9
UW42GY	PC158	1.5mm ²	8P	8P	26	18	9

STECKKLEMMEN

- 24A 450V~, Thermoplast PA, grau
- Klemmen in Leiste: 3÷5
- Steckklemmen 1,5 ÷ 2,5 mm², für harte Drähte
- entspricht EN 60998-1

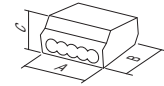
**PLUG-IN WIRE CONNECTORS**

- 24A 450V~, thermoplast PA, grey
- number of poles: 3÷5
- plug-in contacts 1.5÷2.5mm², for rigid wires
- in accordance with EN 60998-1

					A	B	C
UW45GY	PC253	2.5mm ²	3P	3P	14	19	9
UW46GY	PC254	2.5mm ²	4P	4P	17	19	9
UW47GY	PC255	2.5mm ²	5P	5P	21	19	9

STECKKLEMMEN

- 24A 450V~, Thermoplast PA, grau
- Klemmen in Leiste: 2 (harter Draht) + 1 (weicher Draht)
- Steckklemmen 1,5 ÷ 2,5 mm²
- entspricht EN 60998-1

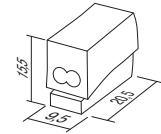
**PLUG-IN WIRE CONNECTOR**

- 24A 450V~, thermoplast PA, grey
- number of poles: 2 (rigid wire) + 1 (soft wire)
- plug-in contacts 1.5÷2.5mm²
- in accordance with EN 60998-1

UW50WH	PC302	2.5mm ²	2/1P				
--------	-------	--------------------	------	--	--	--	--

TEM

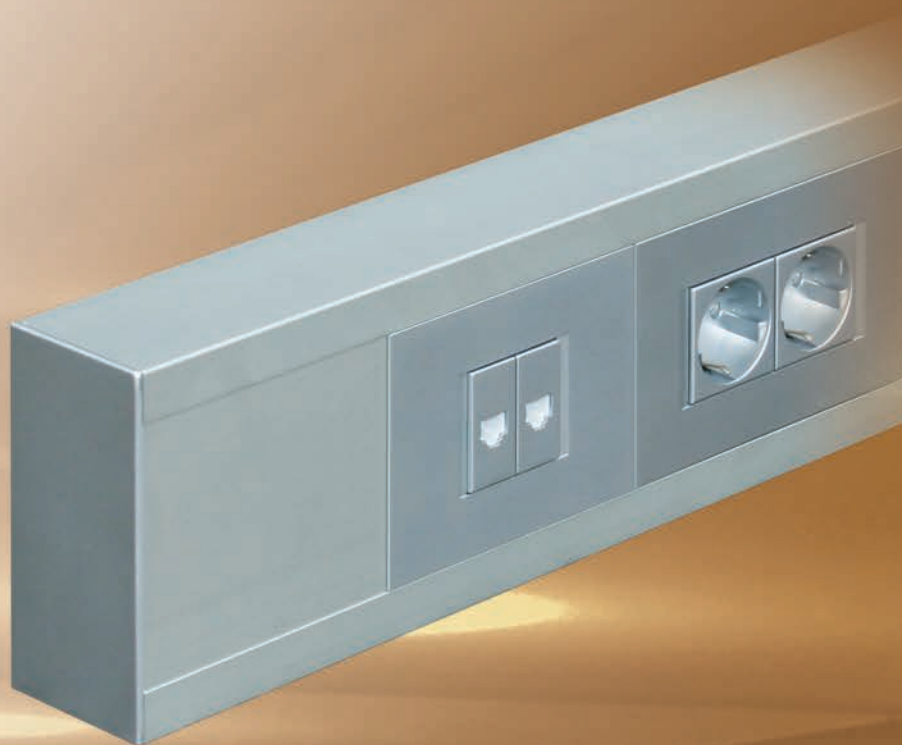

KATALOG / CATALOGUE

Vertrieb



AUFPUTZGEHÄUSE CUBO IP20 AC
BOXES CUBO IP20 AC



140

AUFPUTZGEHÄUSE CUBO IP55 AQ
BOXES CUBO IP55 AQ



141

BRÜSTUNGSKANÄLE ALU MA
TRUNKING SYSTEM ALUMINIUM MA



142

BODENDOSEN MT
FLOOR BOXES MT



147

VERTEILERKASTEN MO
DISTRIBUTION BOARDS MO



150

A U F P U T Z G E H Ä U S E C U B O I P 2 0 A C

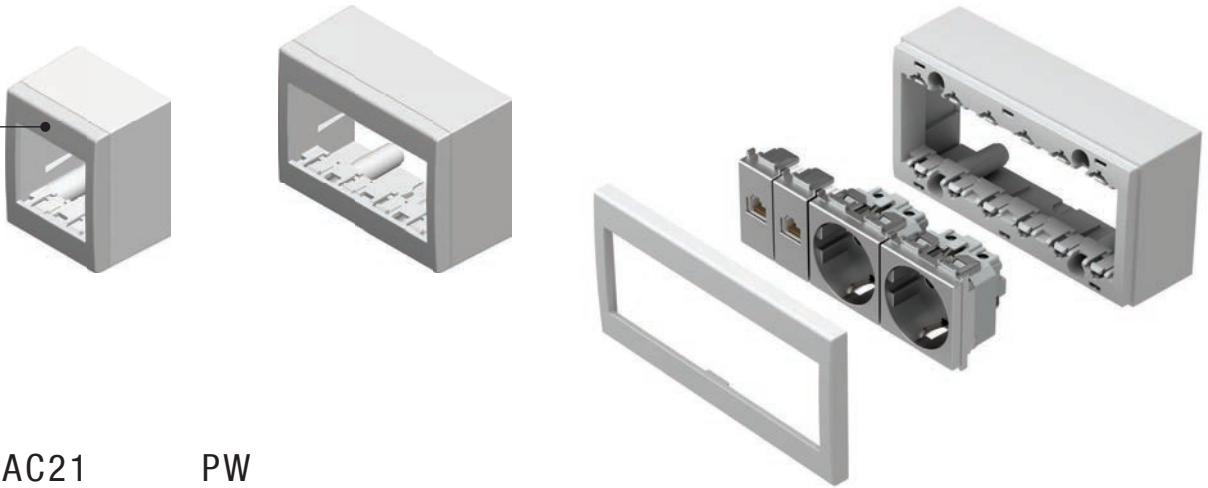

AC21

PW

Typ type	Bezeichnung description	Technische daten technical data	Größe size	Farbe colour
AC11	AUFPUTZGEHÄUSE NO CUBO SURFACE MOUNT BOX	IP20	1M	<input type="checkbox"/> PW Weiß-glänzend polar white
AC21	AUFPUTZGEHÄUSE NO CUBO SURFACE MOUNT BOX	IP20	2M	<input type="checkbox"/> ES Silber-matt elox silver
AC41	AUFPUTZGEHÄUSE NO CUBO SURFACE MOUNT BOX	IP20	4M	<input type="checkbox"/> IW Beige-glänzend ivory white
⋮	⋮	⋮	⋮	

VERTIEB

AUFPUTZGEHÄUSE NO CUBO IP20 1M



- AC11PW
- AC11ES
- AC11IW

- Aufputzgehäuse IP20 1M
- Aufputzbefestigung der Elemente
- geeignet für Schalter SM
- entspricht EN 60669-1

SURFACE MOUNT BOX NO CUBO IP20 1M

- box IP20 1M
- for surface mounting of elements
- suitable to SM switches
- in accordance with EN 60669-1

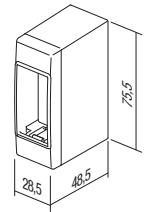

AUFPUTZGEHÄUSE NO CUBO IP20 2M



- AC21PW
- AC21ES
- AC21IW

- Aufputzgehäuse IP20 2M
- Aufputzbefestigung der Elemente
- entspricht EN 60669-1, EN60884-1

SURFACE MOUNT BOX NO CUBO IP20 2M

- box IP20 2M
- for surface mounting of elements
- in accordance with EN 60669-1, EN60884-1

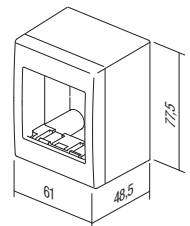

AUFPUTZGEHÄUSE NO CUBO IP20 4M



- AC41PW
- AC41ES
- AC41IW

- Aufputzgehäuse IP20 4M
- Aufputzbefestigung der Elemente
- entspricht EN 60669-1, EN60884-1

SURFACE MOUNT BOX NO CUBO IP20 4M

- box IP20 4M
- for surface mounting of elements
- in accordance with EN 60669-1, EN60884-1

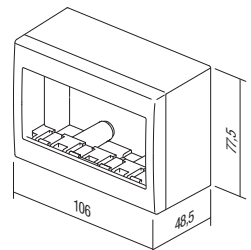

AUFPUTZGEHÄUSE NO CUBO IP20 6M

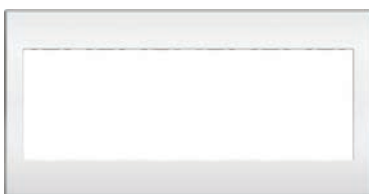

- AC61PW
- AC61ES
- AC61IW

- Aufputzgehäuse IP20 6M
- Aufputzbefestigung der Elemente
- entspricht EN 60669-1, EN60884-1

SURFACE MOUNT BOX NO CUBO IP20 6M

- box IP20 6M
- for surface mounting of elements
- in accordance with EN 60669-1, EN60884-1

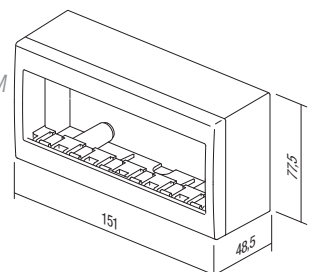

B O X E S C U B O I P 5 5 A Q



Typ type	Bezeichnung description	Technische daten technical data	Größe size	Farbe colour
AQ20	AUFPUTZGEHÄUSE NO CUBO OUTDOOR SURFACE MOUNT BOX	IP55	2M	<input type="checkbox"/> PW Weiß-glänzend polar white
AQ30	AUFPUTZGEHÄUSE NO CUBO OUTDOOR SURFACE MOUNT BOX	IP55	3M	<input checked="" type="checkbox"/> GY Grau grey
AQ31	UNTERPUTZGEHÄUSE PO CUBO OUTDOOR FLUSH MOUNT BOX	IP55	3M	

AUFPUTZGEHÄUSE NO CUBO IP55 2M



- AQ20PW
- AQ20GY

- Aufputzgehäuse IP55 2M
- Aufputzbefestigung der Elemente
- IP55 geeignet für feuchte Räume
- entspricht CEI 23-48, EN 60670

OUTDOOR SURFACE MOUNT BOX NO CUBO IP55 2M
 - box IP55 2M
 - for surface mounting
 - IP55 for usage in humid areas
 - in accordance with CEI 23-48, EN 60670

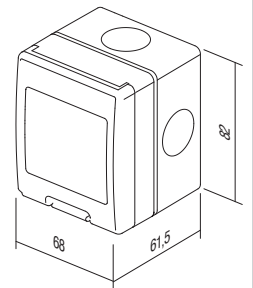

AUFPUTZGEHÄUSE NO CUBO IP55 3M



- AQ30PW
- AQ30GY

- Aufputzgehäuse IP55 3M
- Aufputzbefestigung der Elemente
- IP55 geeignet für feuchte Räume
- entspricht CEI 23-48, EN 60670

OUTDOOR SURFACE MOUNT BOX NO CUBO IP55 3M
 - box IP55 3M
 - for surface mounting
 - IP55 for usage in humid areas
 - in accordance with CEI 23-48, EN 60670

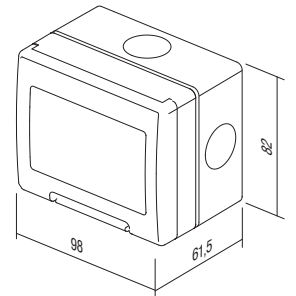

UNTERPUTZGEHÄUSE PO CUBO IP55 3M



- AQ31PW
- AQ31GY

- Unterputzgehäuse IP55 3M
- Unterputzbefestigung der Elemente
- IP55 geeignet für feuchte Räume
- entspricht CEI 23-48, EN 60670

OUTDOOR FLUSH MOUNT BOX PO CUBO IP55 3M
 - box IP55 3M
 - for flush mounting
 - IP55 for usage in humid areas
 - in accordance with CEI 23-48, EN 60670

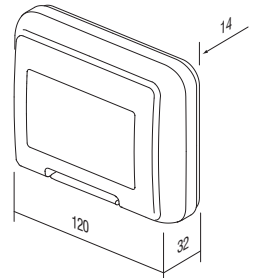

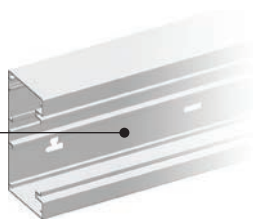
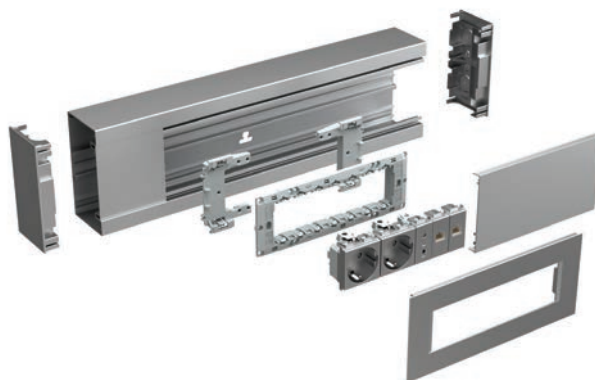

RT20

ES

Typ type	Bezeichnung description	Größe size	Farbe colour
RT10	ADAPTER MA 92 ADAPTER MA 92	/	■ ES Silber-matt elox silver-mat
RT12	RAHMEN MA 92 COVER PLATE MA 92	2/3M	□ PW Weiß-matt (RAL 9016) white-mat
RT14	RAHMEN MA 92 COVER PLATE MA 92	4M	

ADAPTER MA 92



RT10

- Adapter für Befestigung der Montageträger 2/3M-, 4M- bzw. 7M-Modul auf Kanal MA ohne Dose
- 2 Adapter je Träger
- entspricht EN 50085-1

ADAPTER MA 92

- adapter for fixing mounting frames 2/3M, 4M or 7M on MA trunking without box
- each mounting frame needs two adapters
- in accordance with EN 50085-1

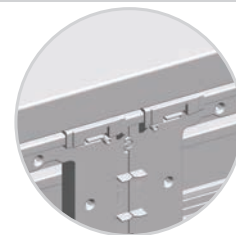

RAHMEN MA 92 2/3M



- RT12ES
- RT12PW

- dekorativer Rahmen MA 2/3M
- entspricht EN 50085-1

COVER PLATE MA 92 2/3M

- decorative cover plate MA 2/3M
- in accordance with EN 50085-1

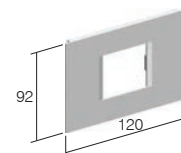

RAHMEN MA 92 4M



- RT14ES
- RT14PW

- dekorativer Rahmen MA 4M
- entspricht EN 50085-1

COVER PLATE MA 92 4M

- decorative cover plate MA 4M
- in accordance with EN 50085-1

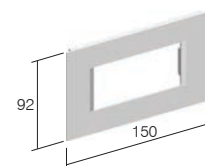

RAHMEN MA 92 7M

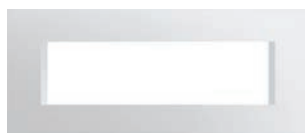

- RT17ES
- RT17PW

- dekorativer Rahmen MA 7M
- entspricht EN 50085-1

COVER PLATE MA 92 7M

- decorative cover plate MA 7M
- in accordance with EN 50085-1

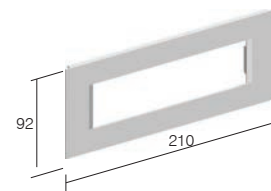

KANALUNTERTEIL MA 130x65

- RT20ES
- RT20PW

- Aluminium-Brüstungskanal zur Montage an der Wand oder auf Wandkonsolen
- Höhe 130 mm, Länge 2 m
- am Kanalboden befindet sich eine 35-mm-DIN-Erdungsschiene
- entspricht EN 50085-11

TRUNKING BASE MA 130x65

- trunking base from extruded aluminium
- height 130mm, length 2m
- DIN - rail 35mm shape on bottom
- in accordance with EN 50085-1

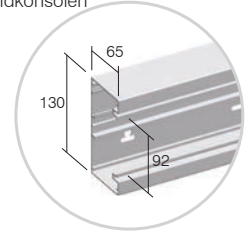
**KANALUNTERTEIL MA 165x65**

- RT21ES
- RT21PW

- Aluminium-Brüstungskanal zur Montage an der Wand oder auf Wandkonsolen
- Höhe 165 mm, Länge 2 m
- am Kanalboden befindet sich eine 35-mm-DIN-Erdungsschiene
- entspricht EN 50085-1

TRUNKING BASE MA 165x65

- trunking base from extruded aluminium
- height 165mm, length 2m
- DIN - rail 35mm shape on bottom
- in accordance with EN 50085-1

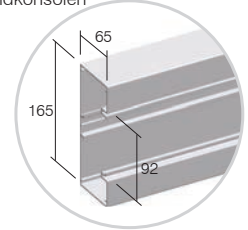
**FRONTABDECKUNG MA 92**

- RT25ES
- RT25PW

- Aluminiumdeckel zur Abdeckung des Unterteils – zum Schutz der Kabel
- Höhe 92 mm, Länge 2 m
- entspricht EN 50085-1

FRONT COVER MA 92

- front cover from extruded aluminium
- height 92mm, length 2m
- in accordance with EN 50085-1

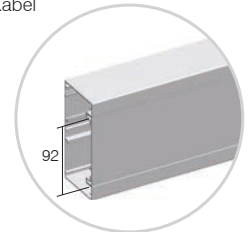
**TRENNWAND MA 43**

RT30

- Kanaltrennwand aus Polymer
- Tiefe 43 mm, Länge 2 m
- entspricht EN 50085-1

CABLE SHELF MA 43

- cable shelf from extruded polymer
- depth 43mm, length 2m
- in accordance with EN 50085-1

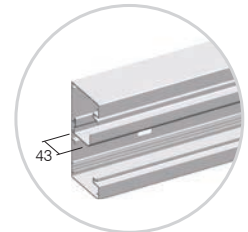
**TRENNWAND MA 43 AL**

RT31

- Kanaltrennwand aus Aluminium
- Tiefe 43 mm, Länge 2 m
- entspricht EN 50085-1

CABLE SHELF MA 43 AL

- cable shelf from extruded aluminium
- depth 43mm, length 2m
- in accordance with EN 50085-1

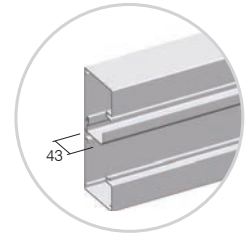
**TRENNWAND MA 43 AL DOPPELT**

RT32

- doppelte Kanaltrennwand aus Aluminium
- Tiefe 43 mm, Länge 2 m
- entspricht EN 50085-1

CABLE SHELF MA 43 AL DOUBLE

- double cable shelf from extruded aluminium
- depth 43mm, length 2m
- in accordance with EN 50085-1

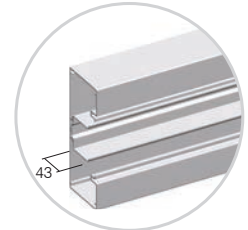



RT35ES
 RT35PW

ENDSTÜCK MA 130x65
- Kanalendstück aus Polymer
- Höhe 130 mm
- entspricht EN 50085-1

STOP END MA 130x65
- stop end element from polymer
- height 130mm
- in accordance with EN 50085-1

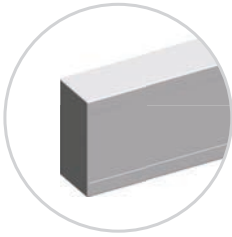

RT36ES
 RT36PW

ENDSTÜCK MA 165x65
- Kanalendstück aus Metall
- Höhe 165 mm
- entspricht EN 50085-1

STOP END MA 165x65
- stop end element from metal
- height 165mm
- in accordance with EN 50085-1



RT38

VERBINDUNGSSTÜCK MA 65
- Kanalverbindungsstück aus Polymer
- inkl. 2 Verbindungsstücken und Schrauben
- entspricht EN 50085-1

SET JOINING PIECE MA 65
- joining piece from polymer
- set contains two pieces and screws
- in accordance with EN 50085-1



RT40ES
 RT40PW

UNIVERSALECK MA 130x65
- Universal-Eckelement für Innen- und Außenecken
- Höhe 130 mm
- entspricht EN 50085-1

UNIVERSAL CORNER MA 130x65
- universal corner element
- height 130mm
- in accordance with EN 50085-1



RT41ES
 RT41PW

UNIVERSALECK MA 165x65
- Universal-Eckelement für Innen- und Außenecken
- Höhe 165 mm
- entspricht EN 50085-1

UNIVERSAL CORNER MA 165x65
- universal corner element
- height 165mm
- in accordance with EN 50085-1





RT42

ERDUNGSKLEMME MA 2x A6.3
- Klemme zur Erdung von Kanalunterteil
bzw. -Deckel
- entspricht EN 50085-1

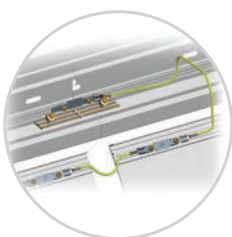
EARTHING PIECE MA 2x A6.3
- earthing piece for earthing of trunking base
and front cover
- in accordance with EN 50085-1

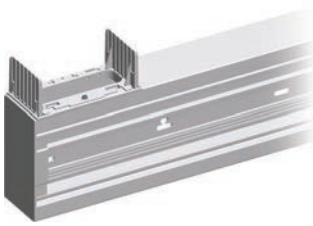

FLACHWINKEL MA 130x65

- RT43ES
- RT43PW

- Universal-Flachwinkel aus Aluminium für L-Verbindungen
 - Höhe 130 mm, Länge 400 mm
 - entspricht EN 50085-1

L-BEND MA 130x65

- universal L bend element from aluminium
 - height 130mm, length 400mm
 - in accordance with EN 50085-1

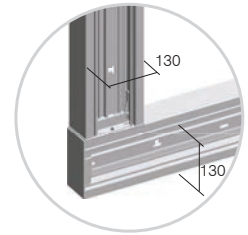
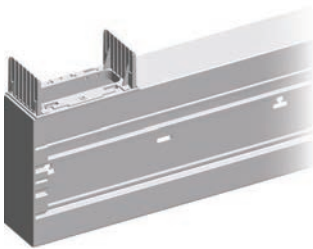
**FLACHWINKEL MA 165x65**

- RT44ES
- RT44PW

- Universal-Flachwinkel aus Aluminium für L-Verbindungen
 - Höhe 165 mm, Länge 400 mm
 - Verbindung auf MA 130x65
 - entspricht EN 50085-1

L-BEND MA 165x65

- universal L bend element from aluminium
 - height 165mm, length 400mm
 - connection on MA 130x65
 - in accordance with EN 50085-1

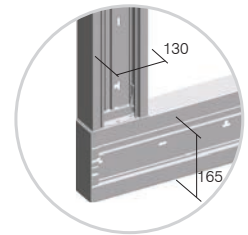
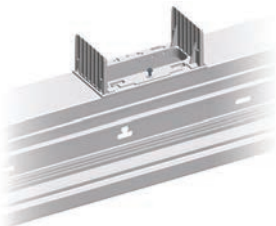
**T-STÜCK MA 130x65**

- RT45ES
- RT45PW

- Universal-T-Stück aus Aluminium für T-Verbindungen
 - Höhe 130 mm, Länge 400 mm
 - entspricht EN 50085-1

T-BEND MA 130x65

- universal T bend element from aluminium
 - height 130mm, length 400mm
 - in accordance with EN 50085-1

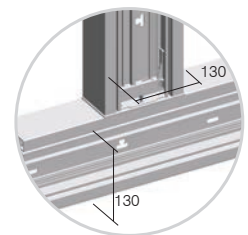
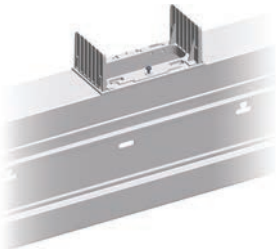
**T-STÜCK MA 165x65**

- RT46ES
- RT46PW

- Universal-T-Stück aus Aluminium für T-Verbindungen
 - Höhe 165 mm, Länge 400 mm
 - Verbindung auf MA 130x65
 - entspricht EN 50085-1

T-BEND MA 165x65

- universal T bend element from aluminium
 - height 165mm, length 400mm
 - connection on MA 130x65
 - in accordance with EN 50085-1

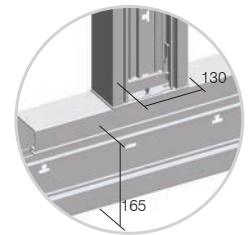

Modul MA basiert auf der Möglichkeit, 2M-, 4M- oder 7M-Elemente zu kombinieren

MA trunking is based on a modular system that creates 2M, 4M or 7M combinations of elements

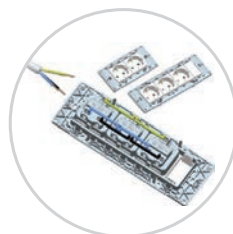

Modul MA beinhaltet spezielle Elemente für eine schnelle Montage.

Our Modul line provides special elements for quick installation

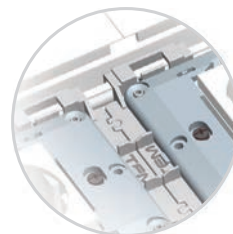

Mit den Adaptern MA ist eine exakte Positionierung auf den Kanalrand möglich.

The MA Adapter enables exact positioning without extra effort

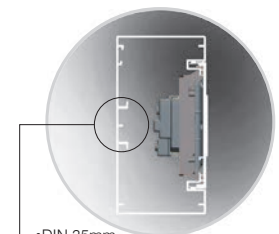

Ohne Montage-Box bedeutet mehr Platz für Kabel, DIN Leiste nach EN-60715.

Mounting without a box means more space for cables, DIN-rail base shape EN-60715

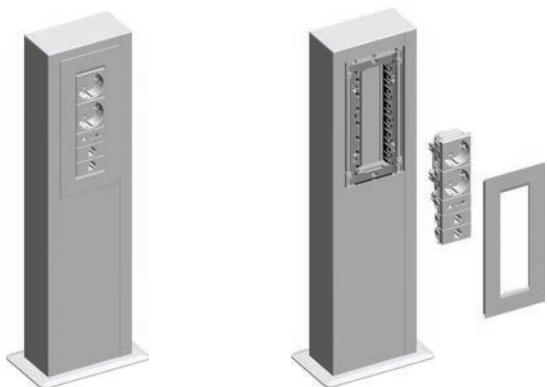

BEFESTIGUNGSPLATTE EINFACH MA 130x65



- RT50ES
- RT50PW

- zur Befestigung der Servicesäulen MA 130 am Boden und/oder auf der Decke
- entspricht EN 50085-1

FIXING PLATE MA SINGLE 130x65
- fixing plate for fixing trunking base MA130 on the floor and/or on the ceiling
- in accordance with EN 50085-1

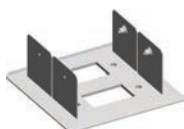

- RT51ES
- RT51PW

- zur Befestigung der Servicesäulen doppelt MA 130 am Boden und/oder auf der Decke
- entspricht EN 50085-1

FIXING PLATE MA DOUBLE 130x65
- fixing plate for fixing two trunking bases MA130 on the floor and/or on the ceiling
- in accordance with EN 50085-1

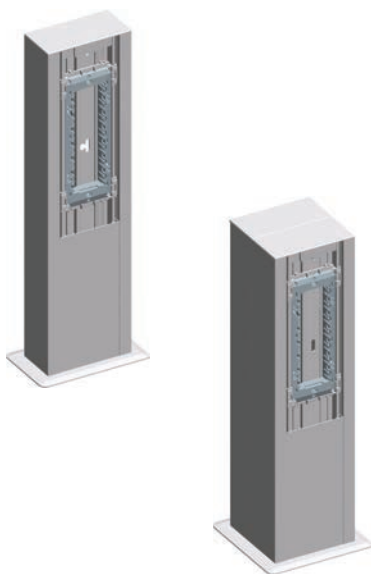

SERVICESÄULE MA 130x65x500

- RT52ES
- RT52PW

- Installationssäule MA
- Höhe 500 mm
- inkl. Montageträger 7M
- entspricht EN 50085-1

SERVICE POST MA 130x65x500
- service post MA
- height 500mm
- mounting frame 7M included
- in accordance with EN 50085-1

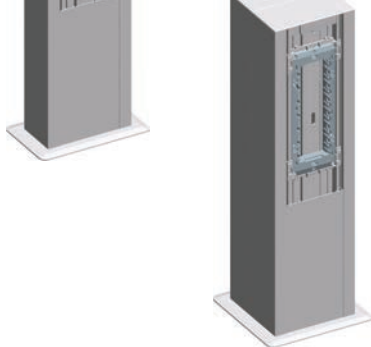
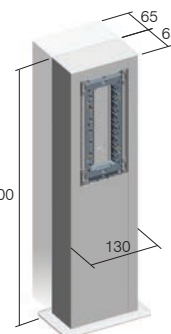

SERVICESÄULE DOPPELT 130x130x500

- RT53ES
- RT53PW

- Installationssäule doppelt MA
- Höhe 500 mm
- inkl. zwei Montageträger 7M
- entspricht EN 50085-1

SERVICE POST MA DOUBLE 130x130x500
- service post MA double
- height 500mm
- mounting frames 7M included
- in accordance with EN 50085-1

Kabelquerschnitt/mm ² / Cable intersection mm ²	Kabelkapazität / Cable cross-section (mm ²)				
	1 Kabel/ 1 wire	2 Kabel/ 2 wires	3 Kabel/ 3 wires	4 Kabel/ 4 wires	5 Kabel/ 5 wires
1,5	44	111	121	144	169
2,5	49	133	157	169	211
4	58	169	183	211	256
6	68	196	225	256	307

Kanalkapazität / Trunk capacity				
Kanal/ trunk	MA 130x65 leer/ empty	MA 130x65 mit Modul-Ausrüstung/ with Modul switches and sockets	MA 165x65 leer/ empty	MA 165x65 mit Modul-Ausrüstung/ with Modul switches and sockets
Kapazität/capacity	7600 mm ²	5500 mm ²	9900 mm ²	7800 mm ²
Max. ø/max ø	54 mm	2x42 mm	54 mm	2x42 mm

F L O O R B O X E S M T

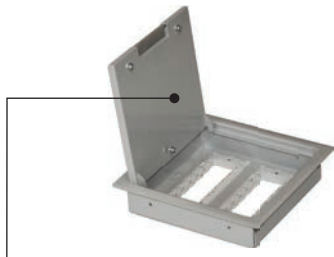
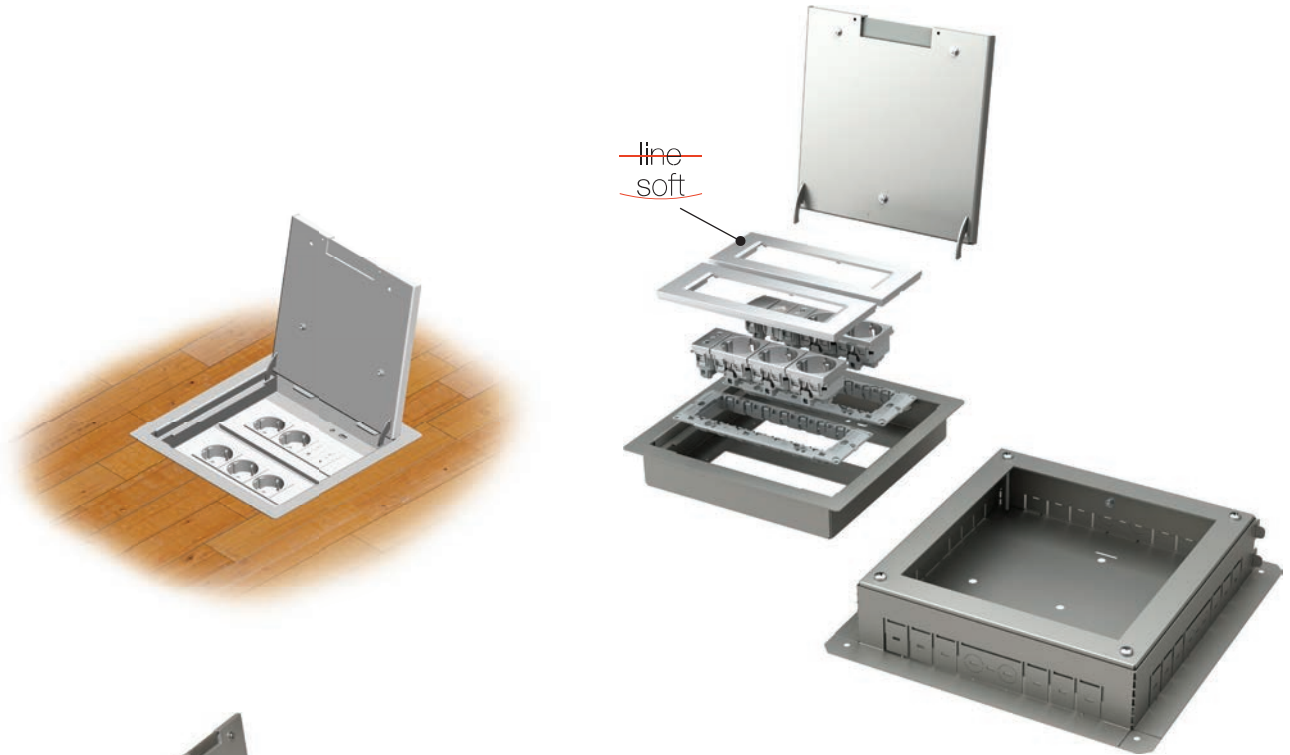

RB33

Typ type	Bezeichnung description	Technische Daten technical data
RB30	BODENDOSE FLOOR BOX	MT 7
RB31	UNTERSATZ FÜR BODENDOSEN FLOOR BOX FLANGE	MT 7
RB33	BODENDOSE FLOOR BOX	MT 14
.	.	.

	RB30	RB33	RB36	RB40	RB43	RB46
a	170	260	350	170	260	350
b	260	260	260	260	260	260
X	140	230	320	140	230	320
Y	230	230	230	230	230	230

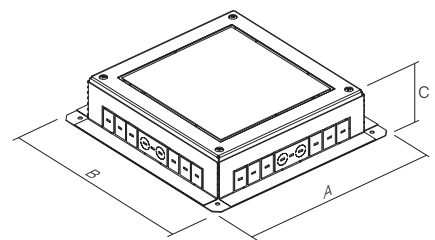
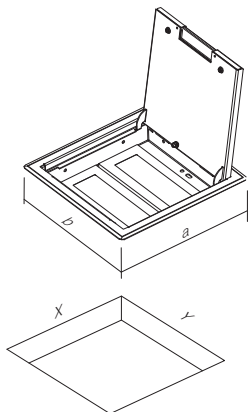

	RB31	RB34	RB37	RB41	RB44	RB47
A	270	360	450	270	360	450
B	360	360	360	360	360	360
C	95-125	95-125	95-125	120-150	120-150	120-150

VERTRIEB

BODENDOSE MT 7



RB30

- Bodendose MT 7
- Metall, silber RAL 9006
- inkl. Montageträger MODUL 7M
- Einbauloch 140x230 mm, Tiefe min. 95 mm
- Dicke des Deckel-Bodenansatzes bis 10 mm
- entspricht EN 50085-2 und EN 50085-2-2

FLOOR BOX MT 7

- floor box MT 7
- metal, colour silver RAL 9006
- mounting frame MODUL 7M included
- mounting dimensions 140x230mm, depth min 95mm
- floor lining thickness up to 10mm
- in accordance with EN 50085-1 and EN 50085-2-2

BODENDOSE MT 7 H=88 mm



RB40

- Bodendose MT 7
- Metall, silber RAL 9006
- inkl. Montageträger MODUL 7M
- Einbauloch 140x230 mm, Tiefe min. 120 mm
- Dicke des Deckel-Bodenansatzes bis 10 mm
- entspricht EN 50085-2 und EN 50085-2-2

FLOOR BOX MT 7 H=88mm

- floor box MT 7
- metal, colour silver RAL 9006
- mounting frame MODUL 7M included
- mounting dimensions 140x230mm, depth min 120mm
- floor lining thickness up to 10mm
- in accordance with EN 50085-1 and EN 50085-2-2

UNTERSATZ FÜR BODENDOSEN MT 7

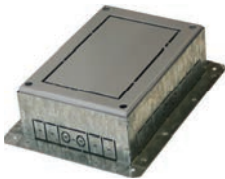

RB31

- Untersatz für Bodendose für Deckel MT 7
- Metall, verzinkt
- für Montage in Pflaster oder Doppelboden
- Einstellhöhe 95-125 mm
- entspricht EN 50085-2 und EN 50085-2-2

FLOOR BOX FLANGE MT 7

- floor box flange for box cover MT 7
- metal, galvanized
- for installation in a floor or double floor
- adjustable height 95-125mm
- in accordance with EN 50085-1 and EN 50085-2-2

UNTERSATZ FÜR BODENDOSEN MT 7 H=88 mm



RB41

- Untersatz für Bodendose für Deckel MT 7 H=88 mm
- Metall, verzinkt
- für Montage in Pflaster oder Doppelboden
- Einstellhöhe 120-150 mm
- entspricht EN 50085-2 und EN 50085-2-2

FLOOR BOX FLANGE MT 7 H=88mm

- floor box flange for box cover MT 7 H=88mm
- metal, galvanized
- for installation in a floor or double floor
- adjustable height 120-150mm
- in accordance with EN 50085-1 and EN 50085-2-2

BODENDOSE MT 14



RB33

- Bodendose MT 14
- Metall, silber RAL 9006
- inkl. Montageträger MODUL 2x7M
- Einbauloch 230x230 mm, Tiefe min. 95 mm
- Dicke des Deckel-Bodenansatzes bis 10 mm
- entspricht EN 50085-2 und EN 50085-2-2

FLOOR BOX MT 14

- floor box MT 14
- metal, colour silver RAL 9006
- mounting frames MODUL 2x7M included
- mounting dimensions 230x230mm, depth min 95mm
- floor lining thickness up to 10mm
- in accordance with EN 50085-1 and EN 50085-2-2

BODENDOSE MT 14 H=88 mm



RB43

- Bodendose MT 14
- Metall, silber RAL 9006
- inkl. Montageträger MODUL 2x7M
- Einbauloch 230x230 mm, Tiefe min. 120 mm
- Dicke des Deckel-Bodenansatzes bis 10 mm
- entspricht EN 50085-2 und EN 50085-2-2

FLOOR BOX MT 14 H=88mm

- floor box MT 14
- metal, colour silver RAL 9006
- mounting frames MODUL 2x7M included
- mounting dimensions 230x230mm, depth min 120mm
- floor lining thickness up to 10mm
- in accordance with EN 50085-1 and EN 50085-2-2

UNTERSATZ FÜR BODENDOSEN MT 14

RB34

- Untersatz für Bodendose für Deckel MT 14
- Metall, verzinkt
- für Montage in Pflaster oder Doppelboden
- Einstellhöhe 95-125 mm
- entspricht EN 50085-2 und EN 50085-2-2

FLOOR BOX FLANGE MT 14

- floor box flange for box cover MT 14
- metal, galvanized
- for installation in a floor or double floor
- adjustable height 95-125mm
- in accordance with EN 50085-1 and EN 50085-2-2

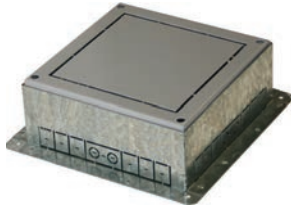
UNTERSATZ FÜR BODENDOSEN MT 14 H=88 mm

RB44

- Untersatz für Bodendose für Deckel MT 14 H=88 mm
- Metall, verzinkt
- für Montage in Pflaster oder Doppelboden
- Einstellhöhe 120-150 mm
- entspricht EN 50085-2 und EN 50085-2-2

FLOOR BOX FLANGE MT 14 H=88mm

- floor box flange for box cover MT 14 H=88mm
- metal, galvanized
- for installation in a floor or double floor
- adjustable height 120-150mm
- in accordance with EN 50085-1 and EN 50085-2-2

BODENDOSE MT 21

RB36

- Bodendose MT 21
- Metall, silber RAL 9006
- inkl. Montageträger MODUL 3x7M
- Einbauloch 320x230 mm, Tiefe min. 95 mm
- Dicke des Deckel-Bodenansatzes bis 10 mm
- entspricht EN 50085-2 und EN 50085-2-2

FLOOR BOX MT 21

- floor box MT 21
- metal, colour silver RAL 9006
- mounting frames MODUL 3x7M included
- mounting dimensions 320x230mm, depth min 95mm
- floor lining thickness up to 10mm
- in accordance with EN 50085-1 and EN 50085-2-2

BODENDOSE MT 21 H=88mm

RB46

- Bodendose MT 21
- Metall, silber RAL 9006
- inkl. Montageträger MODUL 3x7M
- Einbauloch 320x230 mm, Tiefe min. 120 mm
- Dicke des Deckel-Bodenansatzes bis 10 mm
- entspricht EN 50085-2 und EN 50085-2-2

FLOOR BOX MT 21 H=88mm

- floor box MT 21
- metal, colour silver RAL 9006
- mounting frames MODUL 3x7M included
- mounting dimensions 320x230mm, depth min 120mm
- floor lining thickness up to 10mm
- in accordance with EN 50085-1 and EN 50085-2-2

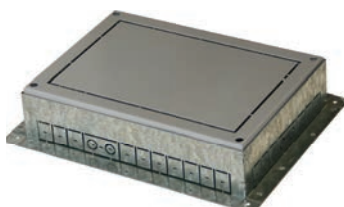
UNTERSATZ FÜR BODENDOSEN MT 21

RB37

- Untersatz für Bodendose für Deckel MT 21
- Metall, verzinkt
- für Montage in Pflaster oder Doppelboden
- Einstellhöhe 95-125 mm
- entspricht EN 50085-2 und EN 50085-2-2

FLOOR BOX FLANGE MT 21

- floor box flange for box cover MT 21
- metal, galvanized
- for installation in a floor or double floor
- adjustable height 95-125mm
- in accordance with EN 50085-1 and EN 50085-2-2

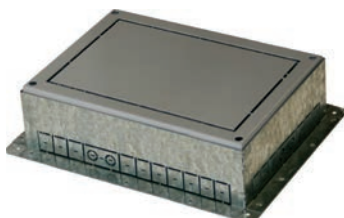
UNTERSATZ FÜR BODENDOSEN MT 21 H=88 mm

RB47

- Untersatz für Bodendose für Deckel MT 21 H=88 mm
- Metall, verzinkt
- für Montage in Pflaster oder Doppelboden
- Einstellhöhe 120-150 mm
- entspricht EN 50085-2 und EN 50085-2-2

FLOOR BOX FLANGE MT 21 H=88mm

- floor box flange for box cover MT 21 H=88mm
- metal, galvanized
- for installation in a floor or double floor
- adjustable height 120-150mm
- in accordance with EN 50085-1 and EN 50085-2-2

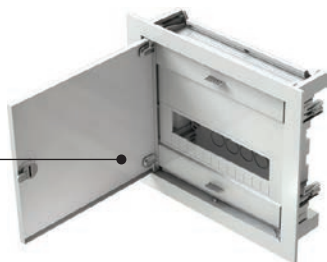
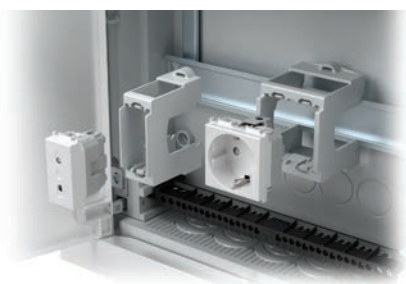

RB20

VERTRIEB

Typ type	Bezeichnung description	Technische Daten technical data
RB10	ADAPTER FÜR DIN-LEISTE ADAPTER FOR DIN RAIL	35mm 1M
RB11	ADAPTER FÜR DIN-LEISTE ADAPTER FOR DIN RAIL	35mm 2M
RB20	VERTEILERKASTEN DISTRIBUTION BOX	MO 12+2
·	·	·
·	·	·

ADAPTER FÜR DIN-LEISTE 35mm 1M



RB10

- Adapter MODUL 1M
- für DIN-Leiste 35 mm
- entspricht EN 50022

ADAPTER FOR DIN RAIL 35mm 1M

- adapter MODUL 1M
- for DIN rail 35mm
- in accordance with EN 50022

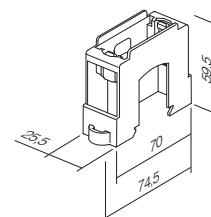

ADAPTER FÜR DIN-LEISTE 35mm 2M



RB11

- Adapter MODUL 2M
- für DIN-Leiste 35 mm
- entspricht EN 50022

ADAPTER FOR DIN RAIL 35mm 2M

- adapter MODUL 2M
- for DIN rail 35mm
- in accordance with EN 50022

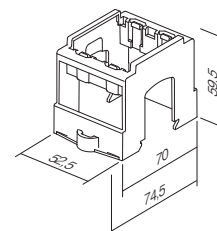

VERTEILERKASTEN MO 12+2



RB20

- Verteilerkasten 1-reihig MO 12+2MU
- 400V~, Schutzklasse II, IP40
- Metallrahmen und -tür, weiß RAL 9016
- inkl. Erdungs- und Nullklemmen
- Universalmontage in Ziegel- und Hohlwand
- entspricht EN 60670-1 und IEC 60670-24

DISTRIBUTION BOX MO 12+2

- distribution box MO single row 12+2MU
- 400V~, Class II, IP40
- metal leveling frame and door, colour white RAL 9016
- neutral and earth conductor terminals enclosed
- universal for brick or hollow wall mounting
- in accordance with EN 60670-1 and IEC 60670-24

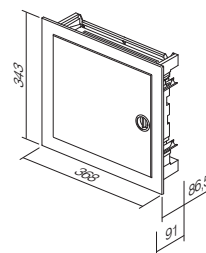

VERTEILERKASTEN MO 24+4



RB21

- Verteilerkasten 2-reihig MO 24+4MU
- 400V~, Schutzklasse II, IP40
- Metallrahmen und -tür, weiß RAL 9016
- inkl. Erdungs- und Nullklemmen
- Universalmontage in Ziegel- und Hohlwand
- entspricht EN 60670-1 und IEC 60670-24

DISTRIBUTION BOX MO 24+4

- distribution box MO double row 24+4MU
- 400V~, Class II, IP40
- metal leveling frame and door, colour white RAL 9016
- neutral and earth conductor terminals enclosed
- universal for brick or hollow wall mounting
- in accordance with EN 60670-1 and IEC 60670-24

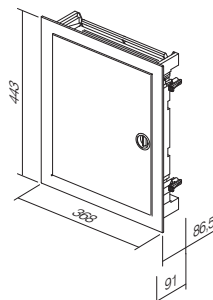

VERTEILERKASTEN MO 36+6



RB22

- Verteilerkasten 3-reihig MO 36+6MU
- 400V~, Schutzklasse II, IP40
- Metallrahmen und -tür, weiß RAL 9016
- inkl. Erdungs- und Nullklemmen
- Universalmontage in Ziegel- und Hohlwand
- entspricht EN 60670-1 und IEC 60670-24

DISTRIBUTION BOX MO 36+6

- distribution box MO triple row 36+6 MU
- 400V~, Class II, IP40
- metal leveling frame and door, colour white RAL 9016
- neutral and earth conductor terminals enclosed
- universal for brick or hollow wall mounting
- in accordance with EN 60670-1 and IEC 60670-24

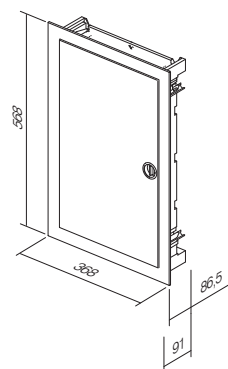

VERTEILERKASTEN MO 48+8



RB23

- Verteilerkasten 3-reihig MO 48+8MU
- 400V~, Schutzklasse II, IP40
- Metallrahmen und -tür, weiß RAL 9016
- inkl. Erdungs- und Nullklemmen
- Universalmontage in Ziegel- und Hohlwand
- entspricht EN 60670-1 und IEC 60670-24

DISTRIBUTION BOX MO 48+8

- distribution box MO quad row 48+8 MU
- 400V~, Class II, IP40
- metal leveling frame and door, colour white RAL 9016
- neutral and earth conductor terminals enclosed
- universal for brick or hollow wall mounting
- in accordance with EN 60670-1 and IEC 60670-24

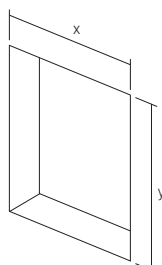
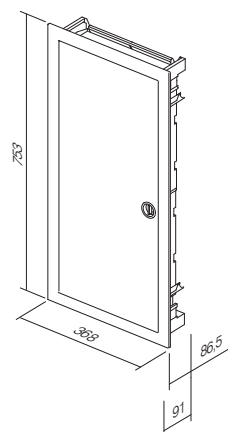

	RB20	RB21	RB22	RB23
x	314	314	314	314
y	314	414	539	724



ekonomik[®]



Planned for excellence
Style is essential



ERGO

METALL

DOFT

Das neutrale, kompakte, elegante Design passt sich jeder Umgebung an, in der Sie wohnen und arbeiten. Im Interieur tritt es nicht hervor, sondern lebt damit harmonisch auf.

A neutral, compact, elegant design is adjustable to every working or living area. It does not stick out from the interior, but rather harmonically fits into it.





Geplante Perfektion Der Stil ist wichtig



Die reine Linie ist sanft abgerundet – eine gut durchdachte Ergonomie speziell für Sie.

A pure line is slightly curved - well considered ergonomics especially for you.



Sie können zwischen glänzenden reflektierenden Flächen und einem modernen Metalldesign wählen.

You can choose between shiny reflective surfaces or a modern metallic look.



Die Weichheit der Form passt sich sowohl modernen wie auch klassischen Interieurs an.

The softness of the form will find its place in modern as well as in classic interiors.

HARMONIE

GLANZ

UV-SCHUTZ

Wünsche können sehr unterschiedlich sein. Genau aus diesem Grund haben wir für Sie mit größter Sorgfalt verschiedene Möglichkeiten gewählt, die Ihnen die richtige Antwort anbieten. Die neutrale Farbpalette wird Ihr Ambiente ergänzen – und nicht begrenzen.

Desires can be very different. Therefore we have carefully selected possibilities for you, which can offer you the right answer. A neutral palette of colours will only complement your ambient - it will not restrict it.

Press and the world will spring to life
Colourful landscape between walls



Die Reflexempfindungen werden durch glänzende Polymermaterialien in weißer und perlweißer (beige) farbe angeboten.

Shiny polymer materials in white and beige colours enable reflective mood.



Modern und neutral ist auch der dekorative Metallanstrich.

Selected decorative metallic coat is at the same time modern and neutral.

Nur ein Druck und die Welt lebt auf Lebendig bunte Räume zwischen den Wänden



Für alle, die Pastellfarben mögen, ist der Ekonomik Colour die richtige Wahl.

For those who want to play with pastel colours Ekonomik Colour represents a perfect solution.



Seine Robustheit und Widerstandsfestigkeit (UV) sind durch das duroplastische Material (Colour) gesichert.

Robustness and high resistance to external effects (UV) are secured by duroplastic materials (Colour line).



VERTIKAL

HORISONTAL

PLATZSPAREND



Mit verschiedenen Kombinationen können Sie Platz an der Wand sparen. Wenn wenig Platz vorhanden ist, dann ist die vertikale Entscheidung richtig.

With combining you save space on the wall. When faced with a limited space, "vertically" is the right decision.



Kombinieren Sie nach Lust und Laune.

Combine as you please.



Die sichtbaren Elemente werden einfach demontiert. Auch die Malermeister werden Ihnen dankbar sein.

Visible elements can be easily taken apart. Painters will be grateful to you.



Prolong your day with a touch
Simplified living

Mit einem Druck den Tag verlängern Vereinfachtes Wohnen

Ekonomik ist die Lösung für das System der runden Standarddosen. Es ist für einfache wie auch anspruchsvollere Installationen, Neubauten und Umbauarbeiten geeignet. Das System zeichnet sich durch schraublose Kontakte aus, die Ihnen viel Zeit beim Einbau der Elemente ersparen.

Ekonomik is a solution for the system of standardized round installations boxes. It can be used for simple as well as more demanding installations, new buildings and adaptations. The system is characterised by plug-in contacts which save time during installation of elements.

Das Wohlfühlen in sicherem Unterschlupf Volles Vertrauen in die gute Konstruktion

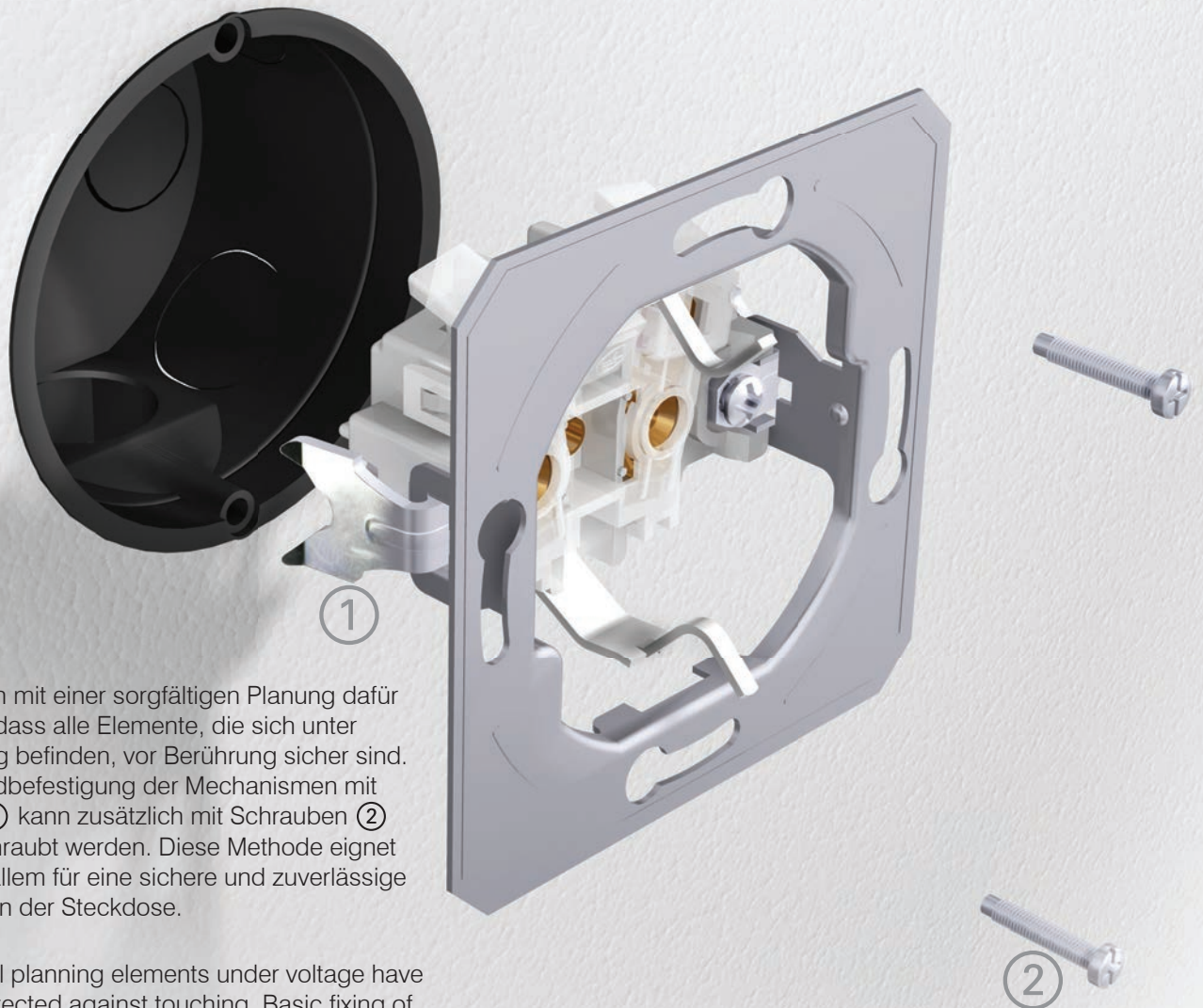

Wir haben mit einer sorgfältigen Planung dafür gesorgt, dass alle Elemente, die sich unter Spannung befinden, vor Berührung sicher sind. Die Grundbefestigung der Mechanismen mit Krallen ① kann zusätzlich mit Schrauben ② festgeschraubt werden. Diese Methode eignet sich vor allem für eine sichere und zuverlässige Installation der Steckdose.

By careful planning elements under voltage have been protected against touching. Basic fixing of mechanisms with fixing claws ① allows additional strengthening with screws ②. This manner is especially appropriate for safe and reliable fixing of sockets.

EINFACH

SCHNELL

FLEXIBEL



Die gut durchdachte Konstruktion des Schalters ermöglicht auch eine einfache nachträgliche Beleuchtung.

A well-planned switch construction makes easy illumination possible also subsequently.



Die schraublosen Kontakte ermöglichen einen schnellen und zuverlässigen Anschluss der Leitungen. An einem Kontakt können zwei Leitungen mit verschiedenen Durchmessern angeschlossen werden.

Plug-in contacts enable quick and reliable attachment of wires. Two wires of different diameters can be attached to the same contact.

Erleichtern Sie sich die Arbeit mit schon zusammengesetzten Dosen, die Ihnen die richtigen Abstände gewährleisten.

Easy-fitting installation boxes will make your work easier. Proper lengths are guaranteed.



Feeling well in a safe shelter Total confidence in a good construction

SICHER

ZUVERLÄSSIG

BEWÄHRT

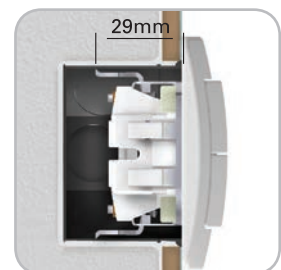

Die Krallen ermöglichen eine tiefere Befestigung (auch an Fliesen usw.).

Fixing claws enable deeper fixing (also through ceramic tiles, etc.)



Alle Schalter haben auf der Vorderseite eine genaue Identifikation.

All switches have a clear identification in the back.

Die Schalter sind gemäß den internationalen Normen geprüft, die die Sicherheit und eine lange Lebensdauer gewährleisten.

Switches were tested according to international standards which guarantee safety and long life span.











Für eine zuverlässige Schaltung sorgen Kontakte aus einer Silberlegierung (AgNi).

Contacts made of silver alloy (Ag-Ni) guarantee safe switching.

TEM





SCHALTER SE SWITCHES SE		164
WIPPEN TE BUTTONS TE		168
BELEUCHTUNG IA ILLUMINATION IA		169
STECKDOSEN VE SOCKETS VE		171
KOMMUNIKATION KE COMMUNICATIONS KE		175
DECKEL PE COVERS PE		179
ELEKTRONIK EE ELECTRONICS EE		180
ZUBEHÖR AE ACCESSORIES AE		184
RAHMEN OE SURROUNDS OE		186



Typ type	Bezeichnung description	Tech. daten technical data	Farbe colour	Optionsbez. 1 optional data 1	Optionsbez. 2 optional data 2
SE10	SCHALTER 1-POLIG SWITCH 1WAY	10AX 250V~	<input type="checkbox"/> PW Weiß-glänzend polar white	NT neutral neutral	50
SE11	WIPPE 1-POLIG PUSH BUTTON 1WAY	10A 250V~	<input type="checkbox"/> IW Beige-glänzend ivory white	IN indikator indication	51
SE22	SCHALTER 2-POLIG SWITCH 2POLE	16AX 250V~	<input type="checkbox"/> ES Silber-matt elox silver		03
			<input type="checkbox"/> CO Weiß, Duroplast white thermoset		04
			<input type="checkbox"/> NB Schwarz-glänzend night black		

SCHALTER 1-POLIG 10AX 250V~



SE10

- 10AX 250V~, Typ SE10
 - entspricht EN 60669-1
 - Steckklemmen 1,5-2,5 mm²
- SWITCH 1WAY 10AX 250V~
- 10AX 250V~, type SE10
 - in accordance with EN 60669-1
 - plug-in contacts 1.5-2.5mm²

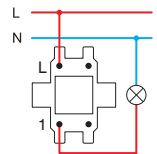

TASTER 1-POLIG 10A 250V~



SE11

- 10A 250V~, Typ SE11
 - entspricht EN 60669-1
 - Steckklemmen 1,5-2,5 mm²
- PUSH BUTTON 1WAY 10A 250V~
- 10A 250V~, type SE11
 - in accordance with EN 60669-1
 - plug-in contacts 1.5-2.5mm²

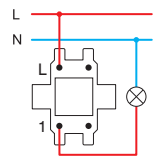

SCHALTER 2-POLIG 16AX 250V~



SE22

- 16AX 250V~, Typ SM22
 - entspricht EN 60669-1
 - Schraubklemmen 1,5-2,5 mm²
 - Nur in Kombination mit Wippe TE10_NT03
- SWITCH 2POLE 16AX 250V~
- 16AX 250V~, type SE22
 - in accordance with EN 60669-1
 - screw contacts 1.5-2.5mm²
 - only in combination with button TE10_NT03

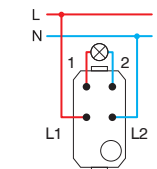
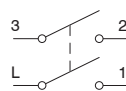

SCHALTER SERIEN 10AX 250V~



SE50

- 10AX 250V~, Typ SE50
 - entspricht EN 60669-1
 - Steckklemmen 1,5-2,5 mm²
- SWITCH 2GANG-1WAY 10AX 250V~
- 10AX 250V~, type SE50
 - in accordance with EN 60669-1
 - plug-in contacts 1.5-2.5mm²

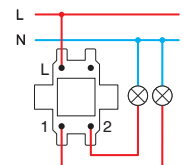
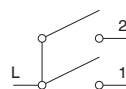

TASTER SERIEN 10A 250V~



SE51

- 10A 250V~, Typ SE51
- entspricht EN 60669-1
- Steckklemmen 1,5-2,5 mm²

PUSH BUTTON 2GANG-1WAY 10A 250V~

- 10A 250V~, type SE51
- in accordance with EN 60669-1
- plug-in contacts 1.5-2.5mm²

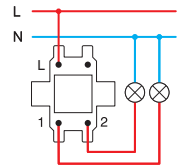
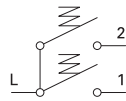

SCHALTER JALOUSIE 10AX 250V~



SE52

- 10AX 250V~, Typ SE52
- entspricht EN 60669-1
- Steckklemmen 1,5-2,5 mm²
- mit mechanischer Verriegelung

SWITCH SHUTTERS 10AX 250V~

- 10AX 250V~, type SE52
- in accordance with EN 60669-1
- plug-in contacts 1.5-2.5mm²
- with mechanical interlock

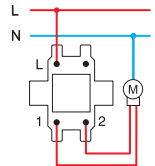
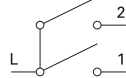

TASTER JALOUSIE 10A 250V~



SE53

- 10A 250V~, Typ SE53
- entspricht EN 60669-1
- Steckklemmen 1,5-2,5 mm²
- mit mechanischer Verriegelung

PUSH BUTTON SHUTTERS 10A 250V~

- 10A 250V~, type SE53
- in accordance with EN 60669-1
- plug-in contacts 1.5-2.5mm²
- with mechanical interblock

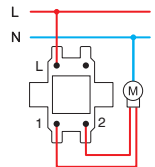
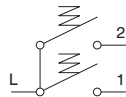

SCHALTER WECHSEL 10AX 250V~



SE60

- 10AX 250V~, Typ SE60
- entspricht EN 60669-1
- Steckklemmen 1,5-2,5 mm²

SWITCH 2WAY 10AX 250V~

- 10AX 250V~, type SE60
- in accordance with EN 60669-1
- plug-in contacts 1.5-2.5mm²

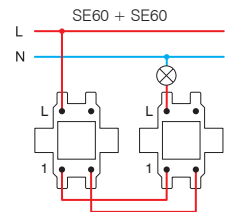
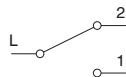

SCHALTER DOPPEL AUS/WECHSEL 10AX 250V~



SE63

- 10AX 250V~, Typ SE63
- entspricht EN 60669-1
- Steckklemmen 1,5-2,5 mm²

SWITCH DOUBLE 2WAY 10AX 250V~

- 10AX 250V~, type SE63
- in accordance with EN 60669-1
- plug-in contacts 1.5-2.5mm²

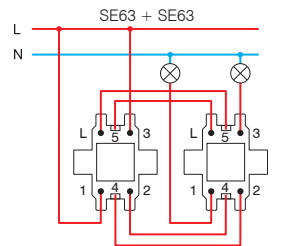

SCHALTER KREUZ 10AX 250V~



SE70

- 10AX 250V~, Typ SE70
- entspricht EN 60669-1
- Steckklemmen 1,5-2,5 mm²

SWITCH INTERMEDIATE 10AX 250V~

- 10AX 250V~, type SE70
- in accordance with EN 60669-1
- plug-in contacts 1.5-2.5mm²

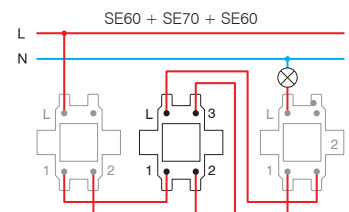

SCHALTER 1-POLIG 10AX 250V~



- SE10PW
- SE10IW
- SE10ES
- SE10CO
- SE10NB

- 10AX 250V~, Typ SE10
- entspricht EN 60669-1
- Steckklemmen 1,5-2,5 mm²

SWITCH 1WAY 10AX 250V~
- 10AX 250V~, type SE10
- in accordance with EN 60669-1
- plug-in contacts 1.5-2.5mm²



SCHALTER 1-POLIG 10AX 250V~ __ IN



- SE10PWIN
- SE10IWIN
- SE10ESIN
- SE10COIN
- SE10NBIN

- IN Indikator
- 10AX 250V~, Typ SE10
- entspricht EN 60669-1
- Steckklemmen 1,5-2,5 mm²

SWITCH 1WAY 10AX 250V~ __ IN
- IN indicator
- 10AX 250V~, type SE10
- in accordance with EN 60669-1
- plug-in contacts 1.5-2.5mm²



TASTER 1-POLIG 10A 250V~



- SE11PW
- SE11IW
- SE11ES
- SE11CO
- SE11NB

- 10A 250V~, Typ SE11
- entspricht EN 60669-1
- Steckklemmen 1,5-2,5 mm²

PUSH BUTTON 1WAY 10A 250V~
- 10A 250V~, type SE11
- in accordance with EN 60669-1
- plug-in contacts 1.5-2.5mm²



TASTER 1-POLIG 10A 250V~ __ TI 50



- SE11PWTI50
- SE11IWTI50
- SE11ESTI50
- SE11COTI50
- SE11NBTI50

- TI 50 Indikator Klingel + Glühlampe
- 10A 250V~, Typ SE11
- entspricht EN 60669-1
- Steckklemmen 1,5-2,5 mm²

PUSH BUTTON 1WAY 10A 250V~ __ TI 50
- TI 50 indicator bell+neon lamp
- 10A 250V~, type SE11
- in accordance with EN 60669-1
- plug-in contacts 1.5-2.5mm²



TASTER 1-POLIG 10A 250V~ __ TI 51



- SE11PWTI51
- SE11IWTI51
- SE11ESTI51
- SE11COTI51
- SE11NBTI51

- TI 51 Indikator Lampe + Glühlampe
- 10A 250V~, Typ SE11
- entspricht EN 60669-1
- Steckklemmen 1,5-2,5 mm²

PUSH BUTTON 1WAY 10A 250V~ __ TI 51
- TI 51 indicator light+neon lamp
- 10A 250V~, type SE11
- in accordance with EN 60669-1
- plug-in contacts 1.5-2.5mm²



TASTER 1-POLIG 10A 250V~ __ IL



- SE11PWIL
- SE11IWIL
- SE11ESIL
- SE11COIL
- SE11NBIL

- IL mit Namensschild
- 10A 250V~, Typ SE11
- entspricht EN 60669-1
- Steckklemmen 1,5-2,5 mm²

PUSH BUTTON 1WAY 10A 250V~ __ IL
- IL inscription plate
- 10A 250V~, type SE11
- in accordance with EN 60669-1
- plug-in contacts 1.5-2.5mm²



SCHALTER 2-POLIG 16AX 250V~ __ NT 03



- SE22PWNT03
- SE22IWNT03
- SE22ESNT03
- SE22NBNT03

- NT 03 neutral 0-1
- 16AX 250V~, Typ SM22
- entspricht EN 60669-1
- Schraubklemmen 1,5-2,5 mm²

SWITCH 2POLE 16AX 250V~ __ NT 03
- NT 03 neutral 0-1
- 16AX 250V~, type SE22
- in accordance with EN 60669-1
- screw contacts 1.5-2.5mm²



SCHALTER SERIEN 10AX 250V~



- SE50PW
- SE50IW
- SE50ES
- SE50CO
- SE50NB

- 10AX 250V~, Typ SE50
- entspricht EN 60669-1
- Steckklemmen 1,5-2,5 mm²

SWITCH 2GANG-1WAY 10AX 250V~

- 10AX 250V~, type SE50
- in accordance with EN 60669-1
- plug-in contacts 1.5-2.5mm²



TASTER SERIEN 10A 250V~



- SE51PW
- SE51IW
- SE51ES
- SE51CO
- SE51NB

- 10A 250V~, Typ SE51
- entspricht EN 60669-1
- Steckklemmen 1,5-2,5 mm²

PUSH BUTTON 2GANG-1WAY 10A 250V~

- 10A 250V~, type SE51
- in accordance with EN 60669-1
- plug-in contacts 1.5-2.5mm²



SCHALTER JALOUSIE 10AX 250V~ __ NT 09



- SE52PWNT09
- SE52IWNT09
- SE52ESNT09
- SE52CONT09
- SE52NBNT09

- NT 09 neutral aufwärts-abwärts
- 10AX 250V~, Typ SE52, entspricht EN 60669-1
- Steckklemmen 1,5-2,5 mm²
- mit mechanischer Verriegelung

SWITCH SHUTTERS 10AX 250V~ __ NT 09

- NT 09 neutral up-down
- 10AX 250V~, type SE52
- in accordance with EN 60669-1
- plug-in contacts 1.5-2.5mm²
- with mechanical interblock



TASTER JALOUSIE 10A 250V~ __ NT 09



- SE53PWNT09
- SE53IWNT09
- SE53ESNT09
- SE53CONT09
- SE53NBNT09

- NT 09 neutral aufwärts-abwärts
- 10A 250V~, Typ SE53,
- entspricht EN 60669-1
- Steckklemmen 1,5-2,5 mm²
- mit mechanischer Verriegelung

PUSH BUTTON SHUTTERS 10A 250V~ __ NT 09

- NT 09 neutral up-down
- 10A 250V~, type SE53
- in accordance with EN 60669-1
- plug-in contacts 1.5-2.5mm²
- with mechanical interblock



SCHALTER WECHSEL 10AX 250V~



- SE60PW
- SE60IW
- SE60ES
- SE60CO
- SE60NB

- 10AX 250V~, Typ SE60
- entspricht EN 60669-1
- Steckklemmen 1,5-2,5 mm²

SWITCH 2WAY 10AX 250V~

- 10AX 250V~, type SE60
- in accordance with EN 60669-1
- plug-in contacts 1.5-2.5mm²



SCHALTER DOPPEL AUS/WECHSEL 10AX 250V~



- SE63PW
- SE63IW
- SE63ES
- SE63CO
- SE63NB

- 10AX 250V~, Typ SE63
- entspricht EN 60669-1
- Steckklemmen 1,5-2,5 mm²

SWITCH DOUBLE 2WAY 10AX 250V~

- 10AX 250V~, type SE63
- in accordance with EN 60669-1
- plug-in contacts 1.5-2.5mm²



SCHALTER KREUZ 10AX 250V~



- SE70PW
- SE70IW
- SE70ES
- SE70CO
- SE70NB

- 10AX 250V~, Typ SE70
- entspricht EN 60669-1
- Steckklemmen 1,5-2,5 mm²

SWITCH INTERMEDIATE 10AX 250V~

- 10AX 250V~, type SE70
- in accordance with EN 60669-1
- plug-in contacts 1.5-2.5mm²

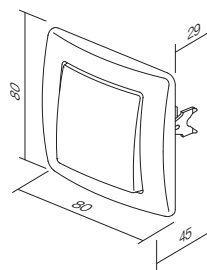
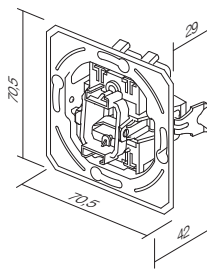

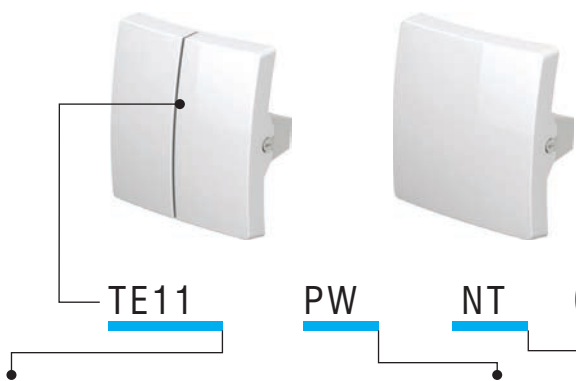

Typ type	Bezeichnung description	Farbe colour	Optionsbez. 1 optional data 1	Optionsbez. 2 optional data 2
TE10	WIPPE NORMAL BUTTON 1GANG	<input type="checkbox"/> PW Weiß-glänzend polar white <input type="checkbox"/> IW Beige-glänzend ivory white <input type="checkbox"/> ES Silber-matt elox silver <input type="checkbox"/> CO Weiß, Duroplast white thermoset <input type="checkbox"/> NB Schwarz-glänzend night black	NT neutral neutral IN indikator indication	50 51 03 04
TE11	WIPPE SERIEN BUTTON 2GANG			

WIPPE NORMAL



- TE10PW
- TE10IW
- TE10ES
- TE10CO
- TE10NB

- Wippe mit Wippenträger
BUTTON 1GANG
- button together with carrier



WIPPE MIT INDIKATOR



- TE10PWIN
- TE10IWIN
- TE10ESIN
- TE10COIN
- TE10NBIN

- Wippe mit Wippenträger
BUTTON INDICATOR
- button together with carrier



WIPPE MIT NAMENSSCHILD



- TE13PWIL
- TE13IWIL
- TE13ESIL
- TE13COIL
- TE13NBIL

- Wippe mit Wippenträger und Namensschild
BUTTON WITH INSCRIPTION PLATE
- button together with carrier, with inscription plate



WIPPE SERIEN



- TE11PW
- TE11IW
- TE11ES
- TE11CO
- TE11NB

- Wippe mit Wippenträger
BUTTON 2GANG
- button 2gang together with carrier

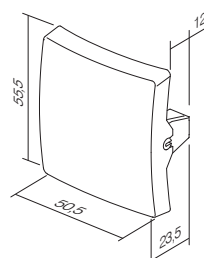
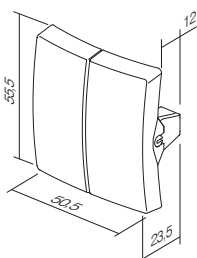

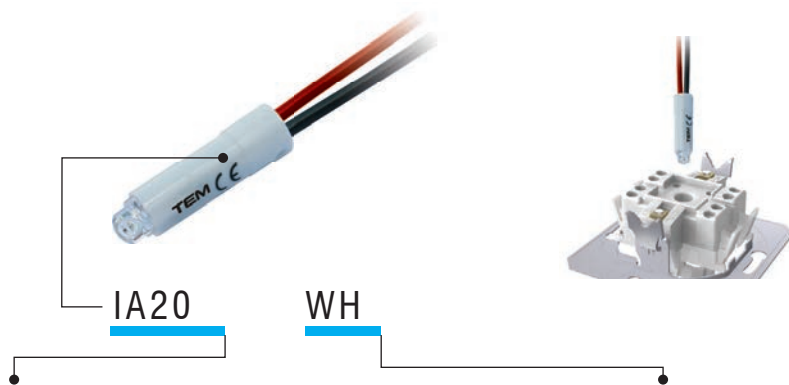

Typ type	Bezeichnung description	Technische daten technical data	Farbe colour
IA10	GLÜHLAMPE NEON LAMP	230V~ 0,34W	<input type="checkbox"/> WH Weiß white
IA20	LED-LAMPE LED LAMP	230V~ 0,40W	<input checked="" type="checkbox"/> BL Blau blue
IA21	LED-LAMPE LED LAMP	24V AC/DC 0,20W	<input checked="" type="checkbox"/> RD Rot red
.	.	.	<input checked="" type="checkbox"/> GR Grün green
.	.	.	<input checked="" type="checkbox"/> OR Orange orange

GLÜHLAMPE 230V~ 0,34 W



IA10OR

- für Kontrollbeleuchtung, Beleuchtung oder ständige Beleuchtung
- in Kombination mit Wippe mit einem Indikator

NEON LAMP 230V~ 0,34W

- for indication, illumination or constant illumination of switch
- in combination with button with indicator

LED-LAMPE 230V AC/DC 0,40 W



IA20WH
 IA20GR
 IA20RD
 IA20BL

- für Kontrollbeleuchtung, Beleuchtung oder ständige Beleuchtung
- in Kombination mit Wippe mit einem Indikator

LED LAMP 230V AC/DC 0,40W

- for indication, illumination or constant illumination of switch
- in combination with button with indicator

LED-LAMPE 24V AC/DC 0,20 W



IA21RD

- für Kontrollbeleuchtung, Beleuchtung oder ständige Beleuchtung
- in Kombination mit Wippe mit einem Indikator

LED LAMP 24V AC/DC 0,20W

- for indication, illumination or constant illumination of switch
- in combination with button with indicator

LED-LAMPE 12V AC/DC 0,10 W



IA22RD

- für Kontrollbeleuchtung, Beleuchtung oder ständige Beleuchtung
- in Kombination mit Wippe mit einem Indikator

LED LAMP 12V AC/DC 0,10W

- for indication, illumination or constant illumination of switch
- in combination with button with indicator

Kontrollbeleuchtung/
Indication ★

Beleuchtung/
Illumination

Ständige Beleuchtung/
Illumination always on ★

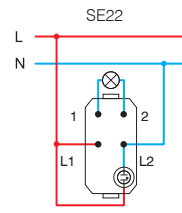
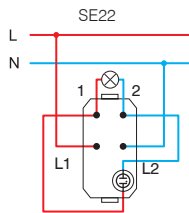
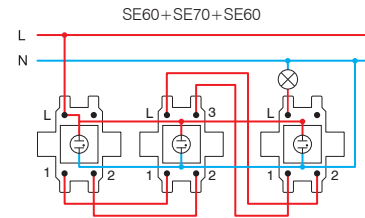
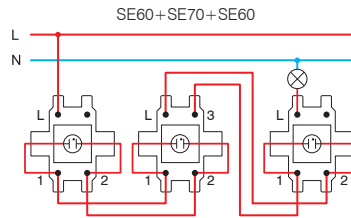
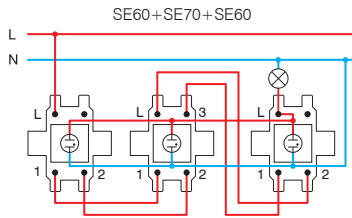
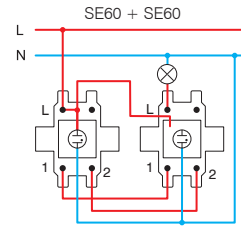
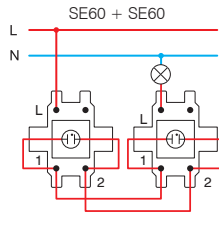
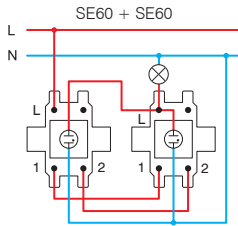
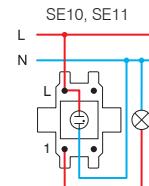
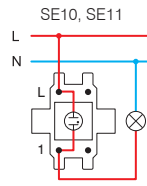
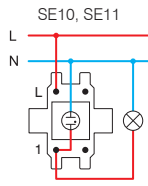

* Schaltungen geeignet für Sparlampen (CFL) / wiring schemes for compact fluid lamp (CFL)

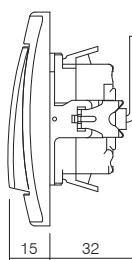

S O C K E T S V E



VE11

PT

XO

KS

Typ type	Bezeichnung description	Tech. daten technical data	Farbe colour	Optionsbez. 1 optional data 1	Optionsbez. 2 optional data 2
VE10	STECKDOSE SCHUKO SOCKET SCHUKO	2P+E 16A 250V~		XO Ohne Rahmen without cover plate	KS Kinderschutz child protection
VE11	STECKDOSE SCHUKO+ KLAPPDECKEL SOCKET SCHUKO+COVER	2P+E 16A 250V~			
VE12	STECKDOSE SCHUKO SOCKET SCHUKO	2P+E 16A 250V~ BV		KS Kinderschutz child protection	

Farbe colour

- | | | |
|--|---|---|
| <input type="checkbox"/> PW Weiß-glänzend
polar white | <input checked="" type="checkbox"/> PT Weiß+transparent
white+transparent | <input type="checkbox"/> PP Weiß+weiß
white+white |
| <input type="checkbox"/> IW Beige-glänzend
ivory white | <input checked="" type="checkbox"/> IT Beige+transparent
ivory+transparent | <input type="checkbox"/> II Beige+transparent
ivory+ivory |
| <input type="checkbox"/> ES Silber-matt
elox silver | <input checked="" type="checkbox"/> ST Silber+transparent
silver+transparent | <input type="checkbox"/> SS Silber+silber
silver+silver |
| <input type="checkbox"/> CO Weiß, Duroplast
white thermoset | <input checked="" type="checkbox"/> CT Weiß+transparent
white+transparent | <input type="checkbox"/> BB Schwarz+schwarz
black+black |
| <input checked="" type="checkbox"/> NB Schwarz-glänzend
night black | <input checked="" type="checkbox"/> BT Schwarz+transparent
black+transparent | <input checked="" type="checkbox"/> RR Rot+rot
red+red |
| <input checked="" type="checkbox"/> RD Rot
red | <input checked="" type="checkbox"/> RT Rot+transparent
red+transparent | <input checked="" type="checkbox"/> GG Grün+grün
green+green |
| <input checked="" type="checkbox"/> GR Grün
green | <input checked="" type="checkbox"/> GT Grün+transparent
green+transparent | <input checked="" type="checkbox"/> OO Orange+orange
orange+orange |
| <input checked="" type="checkbox"/> OR Orange
orange | <input checked="" type="checkbox"/> OT Orange+transparent
orange+transparent | |



Schuko – entspricht EN 60884-1, CEE7 (Seite III)

schuko - in accordance with EN 60884-1, CEE7 (standard sheet III)

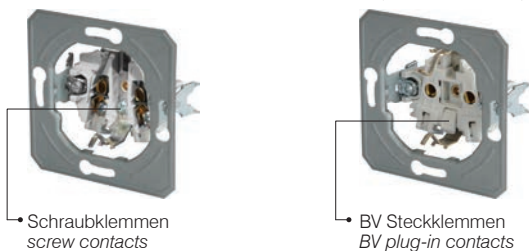

Schraubklemmen
screw contacts

BV Steckklemmen
BV plug-in contacts

Französisch - entspricht NF C 61-314 (Seite V)

French - in accordance with NF C 61-314 (standard sheet V)

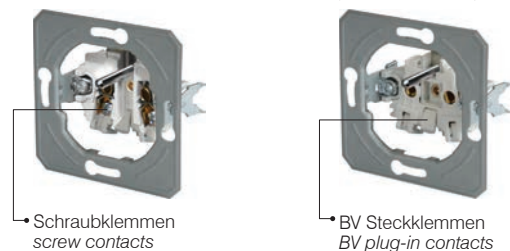

Schraubklemmen
screw contacts

BV Steckklemmen
BV plug-in contacts

STECKDOSE SCHUKO 2P+E 16A 250V~ __ XO



- VE10PWXO
- VE10IWXO
- VE10ESXO
- VE10COXO
- VE10NBXO
- VE10RDXO
- VE10GRXO
- VE10ORXO

- Schraubklemmen 1,5-2,5 mm²
- XO ohne Rahmen
- Steckdose mit Schutzkontakt
- 16A 250V~, Typ VE10

SOCKET SCHUKO 2P+E 16A 250V~ __ XO

- screw contacts 1.5-2.5mm²
- XO without surround
- 2P+E schuko
- 16A 250V~, type VE10



STECKDOSE SCHUKO+DECKEL 2P+E 16A 250V~ __ XO



- VE11PTXO
- VE11ITXO
- VE11STXO
- VE11BTXO

- Schraubklemmen 1,5-2,5 mm²
- XO ohne Rahmen
- Steckdose mit Schutzkontakt mit Klappdeckel
- 16A 250V~, Typ VE11

SOCKET SCHUKO+COVER 2P+E 16A 250V~ __ XO

- screw contacts 1.5-2.5mm²
- XO without surround
- 2P+E schuko+cover
- 16A 250V~, type VE11



STECKDOSE SCHUKO 2P+E 16A 250V~ BV __ XO



- VE12PWXO
- VE12IWXO
- VE12ESXO
- VE12COXO
- VE12NBXO
- VE12RDXO
- VE12GRXO
- VE12ORXO

- BV Steckklemmen 1,5-2,5mm²
- XO ohne Rahmen
- Steckdose mit Schutzkontakt
- 16A 250V~, Typ VE12

SOCKET SCHUKO 2P+E 16A 250V~ BV __ XO

- BV plug-in contacts 1.5-2.5mm²
- XO without surround
- 2P+E schuko
- 16A 250V~, type VE12



STECKDOSE SCHUKO+KLAPPDECKEL 2P+E 16A 250V~ BV __ XO



- VE13PTXO
- VE13ITXO
- VE13STXO
- VE13BTXO
- VE13PPXO

- BV Steckklemmen 1,5-2,5mm²
- XO ohne Rahmen
- Steckdose mit Schutzkontakt mit Klappdeckel
- 16A 250V~, Typ VE13

SOCKET SCHUKO+COVER 2P+E 16A 250V~ BV __ XO

- BV plug-in contacts 1.5-2.5mm²
- XO without surround
- 2P+E schuko+cover
- 16A 250V~, type VE13



STECKDOSE SCHUKO 2P+E 16A 250V~



- VE10PW
- VE10IW
- VE10ES
- VE10CO
- VE10NB

- Schraubklemmen 1,5-2,5 mm²
- Steckdose mit Schutzkontakt
- 16A 250V~, Typ VE10

SOCKET SCHUKO 2P+E 16A 250V~

- screw contacts 1.5-2.5mm²
- 2P+E schuko
- 16A 250V~, type VE10



STECKDOSE SCHUKO+KLAPPDECKEL 2P+E 16A 250V~



- VE11PT
- VE11IT
- VE11ST
- VE11CT
- VE11BT

- Schraubklemmen 1,5-2,5 mm²
- Steckdose mit Schutzkontakt mit Klappdeckel
- 16A 250V~, Typ VE11

SOCKET SCHUKO+COVER 2P+E 16A 250V~

- screw contacts 1.5-2.5mm²
- 2P+E schuko+cover
- 16A 250V~, type VE11



STECKDOSE SCHUKO 2P+E 16A 250V~ BV



- VE12PW
- VE12IW
- VE12ES
- VE12CO
- VE12NB

- BV Steckklemmen 1,5-2,5mm²
- Steckdose mit Schutzkontakt
- 16A 250V~, Typ VE12

SOCKET SCHUKO 2P+E 16A 250V~ BV

- BV plug-in contacts 1.5-2.5mm²
- 2P+E schuko
- 16A 250V~, type VE12



STECKDOSE SCHUKO+KLAPPDECKEL 2P+E 16A 250V~ BV



- VE13PT
- VE13IT
- VE13ST
- VE13CT
- VE13BT

- BV Steckklemmen 1,5-2,5mm²
- Steckdose mit Schutzkontakt mit Klappdeckel
- 16A 250V~, Typ VE13

SOCKET SCHUKO+COVER 2P+E 16A 250V~ BV

- BV plug-in contacts 1.5-2.5mm²
- 2P+E schuko+cover
- 16A 250V~, type VE13

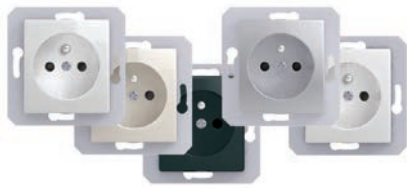

STECKDOSE FRANZÖSISCH 2P+E 16A 250V~ __ XO

- VE40PWXO - Schraubklemmen 1,5-2,5 mm²
- VE40IWXO - XO ohne Rahmen
- VE40ESXO - Steckdose mit Schutzkontakt, französischer Standard
- VE40COXO - 16A 250V~, Typ VE40
- VE40NBXO **SOCKET FRENCH 2P+E 16A 250V~ __ XO**
- VE40RDXO - screw contacts 1.5-2.5mm²
- VE40GRXO - XO without surround
- VE40ORXO - 2P+E French
- 16A 250V~, type VE40

STECKDOSE FRANZÖSISCH 2P+E 16A 250V~ __ XO

- VE41PTXO - Schraubklemmen 1,5-2,5 mm²
- VE41ITXO - XO ohne Rahmen
- VE41STXO - Steckdose mit Schutzkontakt mit Klappdeckel, französischer Standard
- VE41PTXO - 16A 250V~, Typ VE41
- VE41BTXO **SOCKET FRENCH+COVER 2P+E 16A 250V~ __ XO**
- VE41PPXO - screw contacts 1.5-2.5mm²
- XO without surround
- 2P+E French+cover
- 16A 250V~, type VE41

STECKDOSE FRANZÖSISCH 2P+E 16A 250V~ BV __ XO

- VE42PWXO - BV Steckklemmen 1,5-2,5mm²
- VE42IWXO - XO ohne Rahmen
- VE42ESXO - Steckdose mit Schutzkontakt, französischer Standard
- VE42COXO - 16A 250V~, Typ VE42
- VE42NBXO **SOCKET FRENCH 2P+E 16A 250V~ BV __ XO**
- VE42RDXO - BV plug-in contacts 1.5-2.5mm²
- VE42GRXO - XO without surround
- VE42ORXO - 2P+E French
- 16A 250V~, type VE42

STECKDOSE FRANZÖSISCH+KLAPPDECKEL 2P+E 16A 250V~ BV __ XO

- VE43PTXO - BV Steckklemmen 1,5-2,5mm²
- VE43ITXO - XO ohne Rahmen
- VE43STXO - Steckdose mit Schutzkontakt mit Klappdeckel, französischer Standard
- VE43PTXO - 16A 250V~, Typ VE43
- VE43BTXO **SOCKET FRENCH+COVER 2P+E 16A 250V~ BV __ XO**
- VE43PPXO - BV plug-in contacts 1.5-2.5mm²
- XO without surround
- 2P+E French+cover
- 16A 250V~, type VE43

STECKDOSE FRANZÖSISCH 2P+E 16A 250V~

- VE40PW - Schraubklemmen 1,5-2,5 mm²
- VE40IW - Steckdose mit Schutzkontakt, französischer Standard
- VE40ES - 16A 250V~, Typ VE40
- VE40CO **SOCKET FRENCH 2P+E 16A 250V~**
- VE40NB - screw contacts 1.5-2.5mm²
- 2P+E French
- 16A 250V~, type VE40

STECKDOSE FRANZÖSISCH+KLAPPDECKEL 2P+E 16A 250V~

- VE41PT - Schraubklemmen 1,5-2,5 mm²
- VE41IT - Steckdose mit Schutzkontakt mit Klappdeckel, französischer Standard
- VE41ST - 16A 250V~, Typ VE41
- VE41CT **SOCKET FRENCH+COVER 2P+E 16A 250V~**
- VE41BT - screw contacts 1.5-2.5mm²
- 2P+E French+cover
- 16A 250V~, type VE41

STECKDOSE FRANZÖSISCH 2P+E 16A 250V~ BV

- VE42PW - BV Steckklemmen 1,5-2,5 mm²
- VE42IW - Steckdose mit Schutzkontakt, französischer Standard
- VE42ES - 16A 250V~, Typ VE42
- VE42CO **SOCKET FRENCH 2P+E 16A 250V~ BV**
- VE42NB - BV plug-in contacts 1.5-2.5mm²
- 2P+E French
- 16A 250V~, type VE42

STECKDOSE FRANZÖSISCH+KS+KLAPPDECKEL 2P+E 16A 250V~ BV

- VE43PT - BV Steckklemmen 1,5-2,5mm²
- VE43IT - Steckdose mit Schutzkontakt mit Klappdeckel, französischer Standard
- VE43ST - 16A 250V~, Typ VE43
- VE43CT **SOCKET FRENCH+COVER 2P+E 16A 250V~ BV**
- VE43BT - BV plug-in contacts 1.5-2.5mm²
- 2P+E French+cover
- 16A 250V~, type VE43



STECKDOSE SCHUKO DOPPELT 2P+E 16A 250V~



- VE16PW
- VE16IW
- VE16ES
- VE16NB

- 2P+E Doppelsteckdose mit Schutzkontakt
- 16A 250V~, Typ VE16
- entspricht IEC 60884-1, CEE7
- Schraubklemmen 1,5-2,5 mm²
- KS – Kinderschutz gegen Berührung stromführender Teile

SOCKET SCHUKO DOUBLE 2P+E 16A 250V~ BV

- 2P+E schuko double
- 16A 250V~, type VE16
- in accordance with EN-60884-1, CEE7
- KS is not possible
- BV plug-in contacts 1.5-2.5mm²
- KS built-in child protection - shuttered live contacts



STECKDOSE FRANZÖSISCH DOPPELT 2P+E 16A 250V~



- VE46PW
- VE46IW
- VE46ES
- VE46NB

- 2P+E Doppelsteckdose mit Schutzkontakt, französischer Standard
- 16A 250V~, Typ VE46
- entspricht IEC 60884-1, CEE7; NF C 61-314, ČSN 33 2318; PN-E 93201
- Schraubklemmen 1,5-2,5 mm²
- KS – Kinderschutz gegen Berührung stromführender Teile

SOCKET FRENCH DOUBLE 2P+E 16A 250V~

- 2P+E French double
- 16A 250V~, type VE46
- in accordance with EN 60884-1, CEE7, NF C 61-314
- KS is not possible
- screw contacts 1.5-2.5mm²
- KS built-in child protection - shuttered live contacts



STECKDOSE 2P 16A 250V~



- VE30PW
- VE30IW
- VE30ES
- VE30NB

- 2P ohne Erdungskontakt
- 16A 250V~
- entspricht EN 60884-1, CEE7 (Seite I)
- Schraubklemmen 1,5-2,5 mm²

SOCKET 2P 16A 250V~

- 2P without earthing contact
- 16A 250V~
- in accordance with EN 60884-1, CEE7 (standard sheet I)
- screw contacts 1.5-2.5mm²

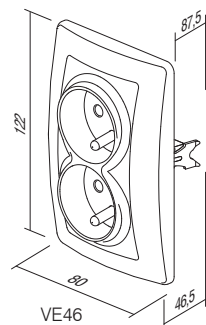
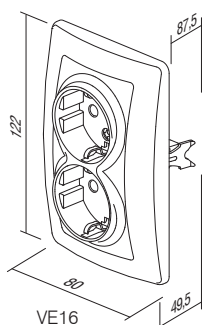
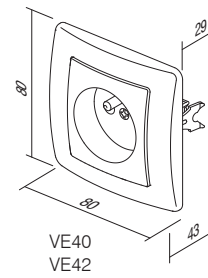
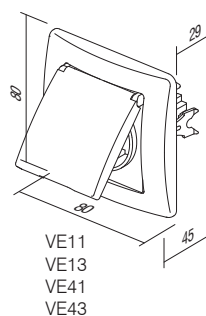
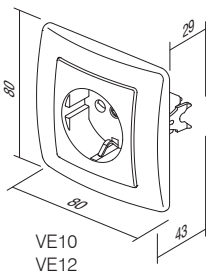
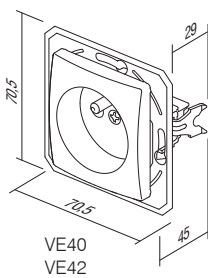
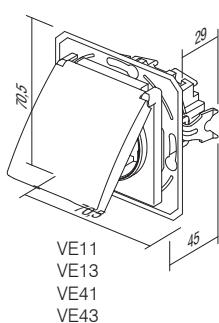
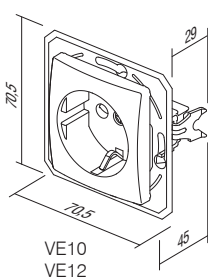

KE37

PW

Typ type	Bezeichnung description	Technische daten technical data	Farbe colour
KE11	STECKDOSE TV-R ENDDOSE SOCKET TV-R END-LINE	2dB	<input type="checkbox"/> PW Weiß-glänzend polar white
KE12	STECKDOSE TV-R DURCHGANGSDOSE SOCKET TV-R THROUGHPASS	8,5dB	<input type="checkbox"/> IW Beige-glänzend ivory white
KE16	STECKDOSE SAT-TV-R ENDDOSE SOCKET SAT-TV-R END-LINE	3dB	<input type="checkbox"/> ES Silber-matt elox silver
			<input type="checkbox"/> CO Weiß, Duroplast white thermoset
			<input type="checkbox"/> NB Schwarz-glänzend night black

STECKDOSE TV-R ENDDOSE 2dB



KE11

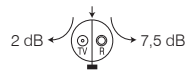

- TV-R Enddose
- Übertragungsbreite 5 ÷ 862 MHz
- Dämpfung: R-7,5 dB, TV-2 dB
- entspricht EN 50083-1
- Schraubklemmen

SOCKET TV-R END-LINE 2dB

- TV-R end-line
- frequency range 5 ÷ 862MHz
- reduction: R-7.5dB, TV-2dB
- in accordance with EN 50083-1
- screw contacts

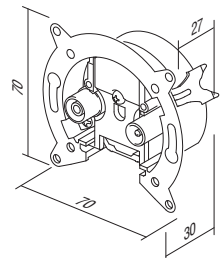

STECKDOSE TV-R DURCHGANGSDOSE 8,5dB



KE12

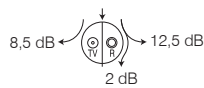

- TV-R Durchgangsdose
- Übertragungsbreite 5 ÷ 862 MHz
- Dämpfung: R-12,5 dB, TV-8,5 dB, Durchgang-2 dB
- entspricht EN 50083-1
- Schraubklemmen

SOCKET TV-R THROUGHPASS 8,5dB

- TV-R throughpass
- frequency range 5 ÷ 862MHz
- reduction: R-12.5dB, TV-8.5dB, through-2dB
- in accordance with EN 50083-1
- screw contacts

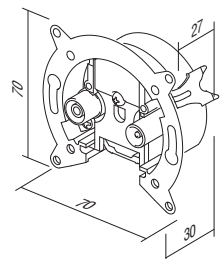

STECKDOSE SAT-TV-R ENDDOSE 3dB



KE16

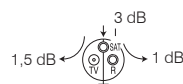

- SAT-TV-R Enddose
- Übertragungsbreite 5 ÷ 2400MHz
- Dämpfung: R-1dB, TV-1,5 dB, SAT-3 dB
- Montage in der Wanddose Ø60 mit Krallen oder Schrauben
- entspricht EN 50083-1
- Schraubklemmen

SOCKET SAT-TV-R END-LINE 3dB

- SAT-TV-R end-line
- frequency range 5 ÷ 2400MHz
- reduction: R-1dB, TV-1.5dB, SAT-3dB
- for mounting in round box Ø60 with claws or screws
- in accordance with EN 50083-1
- screw contacts

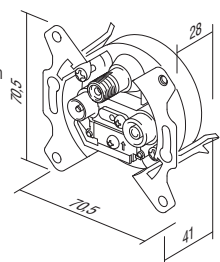

STECKDOSE TEL KS RJ11 6/4



KE36

- KS keystone-Befestigungsstandard
- RJ11 6/4
- entspricht IEC 60603-7

SOCKET TEL KS RJ11 6/4

- KS keystone fixing standard
- RJ11 6/4
- in accordance with IEC 60603-7

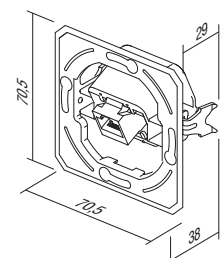



KE37

STECKDOSE CAT5e KS RJ45 8/8

- KS keystone-Befestigungsstandard
- CAT5e, RJ45 8/8
- entspricht IEC 60603-7

SOCKET CAT5e KS RJ45 8/8

- KS keystone fixing standard
- CAT5e, RJ45 8/8
- in accordance with IEC 60603-7

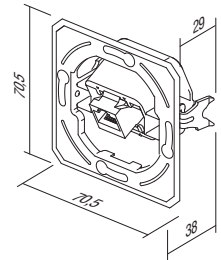

KE38

STECKDOSE TEL KS DOPPELT 2x RJ11 6/4

- KS keystone-Befestigungsstandard
- 2x RJ11 6/4
- entspricht IEC 60603-7

SOCKET TEL KS DOUBLE 2x RJ11 6/4

- KS keystone fixing standard
- 2x RJ11 6/4
- in accordance with IEC 60603-7

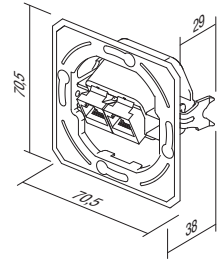

KE39

STECKDOSE CAT5e KS DOPPELT 2x RJ45 8/8

- KS keystone-Befestigungsstandard
- 2x CAT5e, RJ45 8/8
- entspricht IEC 60603-7

SOCKET CAT5e KS DOUBLE 2x RJ45 8/8

- KS keystone fixing standard
- 2x CAT5e, RJ45 8/8
- in accordance with IEC 60603-7

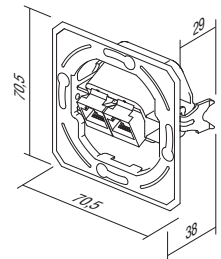

KE45

ADAPTER KS EINFACH

- KS keystone-Befestigungsstandard – einfach
- AMP, Avaya, Brandrex, FMT, Mfico, Tyco, ...
- ohne Kommunikationsmodul

ADAPTER KS SINGLE

- KS keystone fixing standard - single
- AMP, Avaya, Brandrex, FMT, Mfico, Tyco, ...
- communication module not included

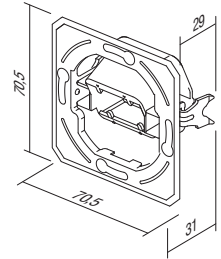

KE46

ADAPTER KS DOPPELT

- KS keystone-Befestigungsstandard – doppelt
- AMP, Tyco, ...
- ohne Kommunikationsmodul

ADAPTER KS DOUBLE

- KS keystone fixing standard - double
- AMP, Tyco, ...
- communication module not included

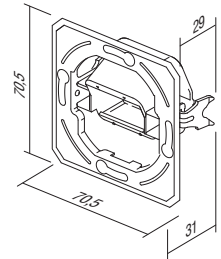

KE47

ADAPTER PD DOPPELT

- PD Panduit MiniCOM-Befestigungsstandard – doppelt
- ohne Kommunikationsmodul

ADAPTER PD DOUBLE

- PD Panduit Mini-COM fixing standard - double
- communication module not included

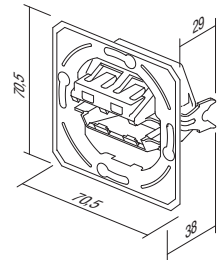

STECKDOSE TV-EINZELDOSE 0dB

- KE10PW
- KE10IW
- KE10ES
- KE10CO
- KE10NB

- TV-Einzeldose
 - Dämpfung 0 dB
 - Rückanschluss – F-Standard
- SOCKET TV BASIC 0dB**
- TV basic
 - reduction 0dB
 - back connector – F standard

**STECKDOSE TV-R-ENDDOSE 2dB**

- KE11PW
- KE11IW
- KE11ES
- KE11CO
- KE11NB

- TV-R-Enddose
 - Übertragungsbandbreite 5÷862 MHz
 - Dämpfung: R-7,5 dB, TV-2 dB
 - entspricht EN 50083-1
 - Schraubklemmen
- SOCKET TV-R END-LINE 2dB**
- TV-R end-line
 - frequency range 5÷862 MHz
 - reduction: R-7.5dB, TV-2dB
 - in accordance with EN 50083-1
 - screw contact

**STECKDOSE TV-R-DURCHGANGSDOSE 8,5dB**

- KE12PW
- KE12IW
- KE12ES
- KE12CO
- KE12NB

- TV-R-Durchgangsdose
 - Übertragungsbandbreite 5÷862 MHz
 - Dämpfung: R-12,5 dB, TV-8,5 dB, Durchgang-2 dB
 - entspricht EN 50083-1
 - Schraubklemmen
- SOCKET TV-R THROUGHPASS 8,5dB**
- TV-R throughpass
 - frequency range 5÷862 MHz
 - reduction: R-12.5dB, TV-8.5dB, through-2dB
 - in accordance with EN 50083-1
 - screw contacts

**STECKDOSE SAT-TV-R-ENDDOSE 3dB**

- KE16PW
- KE16IW
- KE16ES
- KE16CO
- KE16NB

- SAT-TV-R-Enddose
 - Übertragungsbandbreite 5÷2400 MHz
 - Dämpfung: R-1dB, TV-1,5 dB, SAT-3 dB
 - entspricht EN 50083-1
 - Schraubklemmen
- SOCKET SAT-TV-R END-LINE 3dB**
- SAT-TV-R end-line
 - frequency range 5÷2400 MHz
 - reduction: R-1dB, TV-1.5dB, SAT-3dB
 - in accordance with EN 50083-1
 - screw contacts

**STECKDOSE AUDIO 2xRCA**

- KE22PW
- KE22IW
- KE22ES
- KE22CO
- KE22NB

- audio 2xRCA
 - Gelöteter Kabelanschluss
- SOCKET AUDIO 2xRCA**
- audio 2xRCA
 - soldering connection of cable

**STECKDOSE AUDIO FÜR LAUTSPRECHER**

- KE23PW
- KE23IW
- KE23ES
- KE23CO
- KE23NB

- Audio-Anschlussdose – 2x Ø4 mm
 - Kabelanschluss für Lautsprecher, Stecker Ø4 mm oder Gabel-Kabelstecker
 - gelöteter Kabelanschluss hinten
- SOCKET AUDIO LOUDSPEAKERS**
- audio 2x Ø4mm
 - to accommodate speaker wire, banana plug Ø4mm or spades
 - soldering connection of cable at the back side



STECKDOSE TEL KS RJ11 6/4



- KE36PW
- KE36IW
- KE36ES
- KE36CO
- KE36NB

- KS keystone-Befestigungsstandard
- RJ11 6/4
- entspricht IEC 60603-7

SOCKET TEL KS RJ11 6/4

- KS keystone fixing standard
- RJ11 6/4
- in accordance with IEC 60603-7



STECKDOSE CAT5e KS RJ45 8/8



- KE37PW
- KE37IW
- KE37ES
- KE37CO
- KE37NB

- KS keystone-Befestigungsstandard
- CAT5e, RJ45 8/8
- entspricht IEC 60603-7

SOCKET CAT5e KS RJ45 8/8

- KS keystone fixing standard
- CAT5e, RJ45 8/8
- in accordance with IEC 60603-7



STECKDOSE TEL KS DOPPELT 2x RJ11 6/4



- KE38PW
- KE38IW
- KE38ES
- KE38CO
- KE38NB

- KS keystone-Befestigungsstandard
- 2x RJ11 6/4
- entspricht IEC 60603-7

SOCKET TEL KS DOUBLE 2x RJ11 6/4

- KS keystone fixing standard
- 2x RJ11, 6/4
- in accordance with IEC 60603-7



STECKDOSE CAT5e KS DOPPELT 2x RJ45 8/8



- KE39PW
- KE39IW
- KE39ES
- KE39CO
- KE39NB

- KS keystone-Befestigungsstandard
- 2x CAT5e, RJ45 8/8
- entspricht IEC 60603-7

SOCKET CAT5e KS DOUBLE 2x RJ45 8/8

- KS keystone fixing standard
- 2x CAT5e, RJ45 8/8
- in accordance with IEC 60603-7



STECKDOSE TEL LT RJ11 6/4



- KE35PW
- KE35IW
- KE35ES
- KE35CO
- KE35NB

- TEL LT mit Schraubklemmen
- Schraubklemmen
- RJ11 6/4
- entspricht IEC 60603-7

SOCKET TEL LT RJ11 6/4

- TEL LT screw
- screw contacts
- RJ11 6/4
- in accordance with IEC 60603-7

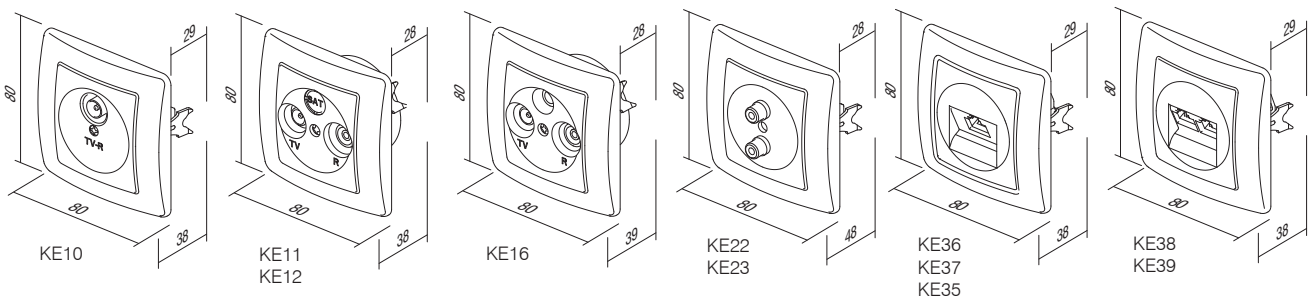

DECKEL KOMMUNIKATION KE

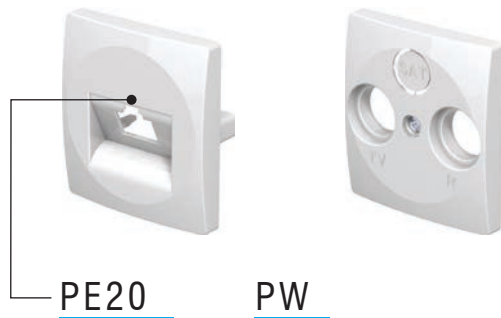

Typ type	Bezeichnung description	Technische daten technical data	Farbe colour
PE10	DECKEL TV-R COVER TV-R	2P/3P	<input type="checkbox"/> PW Weiß-glänzend polar white
PE20	DECKEL KS EINFACH COVER KS SINGLE		<input type="checkbox"/> IW Beige-glänzend ivory white
PE21	DECKEL KS DOPPELT COVER KS DOUBLE		<input type="checkbox"/> ES Silber-matt elox silver
...	<input type="checkbox"/> CO Weiß, Duroplast white thermoset
...	<input type="checkbox"/> NB Schwarz-glänzend night black

DECKEL TV-R 2P/3P



- PE10PW
- PE10IW
- PE10ES
- PE10CO
- PE10NB

- TV-R-Deckel, 2P oder 3P mit Schraube
COVER TV-R 2P/3P

- TV-R cover, 2P or 3P with screw



DECKEL KS EINFACH

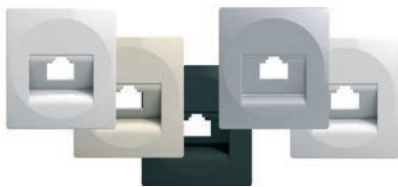

- PE20PW
- PE20IW
- PE20ES
- PE20CO
- PE20NB

- KS-Deckel einfach
COVER KS SINGLE

- KS cover single



DECKEL KS DOPPELT

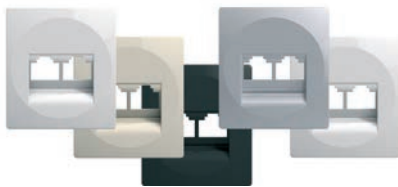

- PE21PW
- PE21IW
- PE21ES
- PE21CO
- PE21NB

- KS-Deckel doppelt
COVER KS DOUBLE

- KS cover double



DECKEL TAE/TDO



- PE30PW
- PE30IW
- PE30ES
- PE30CO
- PE30NB

- TAE- oder TDO-Deckel mit Schraube
COVER TAE/TDO

- TAE or TDO cover with screw

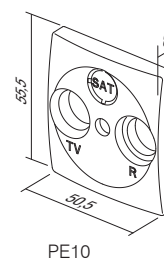
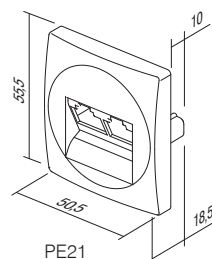
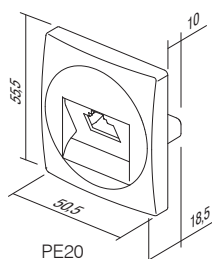
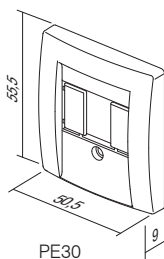



EE15

PW

Typ type	Bezeichnung description	Technische daten technical data	Farbe colour
EE15	DIMMER DREH-WECHSEL DIMMER ROTATIVE 2WAY	RL 400W	<input type="checkbox"/> PW Weiß-glänzend polar white
EE16	DIMMER DREH-WECHSEL DIMMER ROTATIVE 2WAY	RLC 400W	<input type="checkbox"/> IW Beige-glänzend ivory white
EE17	DIMMER DREH-AUS DIMMER ROTATIVE	FAN 600VA	<input type="checkbox"/> ES Silber-matt elox silver
.	.	.	<input type="checkbox"/> CO Weiß, Duroplast white thermoset
.	.	.	<input type="checkbox"/> NB Schwarz-glänzend night black

DIMMER DRUCK-WECHSEL RL 400W



EE15

- Druck-Wechsel
- Belastung RL, 40W - 400W
- kann mit Wechselschalter verbunden werden
- Verbindung von zwei Dimmern ist nicht gestattet
- entspricht EN 60669-1 und EN 60669-2-1
- Schraubklemmen 1,5 mm²
- Versorgung 230V~ 50Hz
- Durchmesser Knopf Ø6mm
- inkl. Sicherung auswechselbar

DIMMER ROTATIVE 2WAY RL 400W

- rotation control with 2-way switch
- load RL, 40W - 400W
- 2-way switch combination is possible
- more dimmers combination is not allowed
- in accordance with EN 60669-1 and EN 60669-2-1
- plug-in contacts 1.5mm²
- supply 230V~ 50Hz
- button inner diameter Ø6mm
- replaceable fuse included

DIMMER DRUCK-WECHSEL RLC 400W



EE16

- Druck-Wechsel
- Belastung RLC, 40W - 400W
- kann mit Wechselschalter verbunden werden
- Verbindung von zwei Dimmern ist nicht gestattet
- entspricht EN 60669-1 und EN 60669-2-1
- Schraubklemmen 1,5 mm²
- Versorgung 230V~ 50Hz
- Durchmesser Knopf Ø6 mm
- Elektroniksicherung

DIMMER ROTATIVE 2WAY RLC 400W

- rotation control with 2-way switch
- load RLC, 20W - 400W
- 2-way switch combination is possible
- more dimmers combination is not allowed
- in accordance with EN 60669-1 and EN 60669-2-1
- plug-in contacts 1.5mm²
- button inner diameter Ø6mm
- supply 230V~ 50Hz
- electronic fuse



EE17

DIMMER DREH-AUS FÜR LÜFTER 600VA

- Dreh mit Schalter
- typ 456; Belastung: Motor, 25VA - 600VA
- kann nicht mit Wechselschalter verbunden werden
- Verbindung von zwei Dimmern ist nicht gestattet
- entspricht EN 60669-1 und EN 60669-2-1
- Schraubklemmen 1,5 mm²
- Versorgung 230 V~ 50 Hz
- Durchmesser Knopf Ø4 mm
- inkl. Sicherung auswechselbar

DIMMER ROTATIVE FAN 600VA

- rotation control with switch
- type 456; load: motor, 25VA - 600VA
- 2-way switch combination is not possible
- more dimmers combination is not allowed
- in accordance with EN 60669-1 and EN 60669-2-1
- plug-in contacts 1.5mm²
- supply 230V~ 50Hz
- button inner diameter Ø4mm
- replaceable fuse included

DIMMER DRUCK-WECHSEL RL 400W

- EE15PW
- EE15IW
- EE15ES
- EE15CO
- EE15NB

- Druck-Wechsel
- Belastung RL, 40 W – 400 W
- kann mit Wechselschalter verbunden werden
- Verbindung von zwei Dimmern ist nicht gestattet
- entspricht EN 60669-1 und EN 60669-2-1
- Schraubklemmen 1,5 mm²
- Versorgung 230 V~ 50 Hz
- inkl. Sicherung auswechselbar

**DIMMER ROTATIVE 2WAY RL 400W**

- rotation control with 2-way switch
- load RL, 40W - 400W
- 2-way switch combination is possible
- more dimmers combination is not allowed
- in accordance with EN 60669-1 and EN 60669-2-1
- plug-in contacts 1.5mm²
- supply 230V~ 50Hz
- replaceable fuse included

DIMMER DRUCK-WECHSEL RLC 400W

- EE16PW
- EE16IW
- EE16ES
- EE16CO
- EE16NB

- Druck-Wechsel
- Belastung RL, 20 W – 400 W
- kann mit Wechselschalter verbunden werden
- Verbindung von zwei Dimmern ist nicht gestattet
- entspricht EN 60669-1 und EN 60669-2-1
- Schraubklemmen 1,5 mm²
- Versorgung 230 V~ 50 Hz
- Elektroniksicherung

**DIMMER ROTATIVE 2WAY RLC 400W**

- rotation control with 2-way switch
- load RLC, 20W - 400W
- 2-way switch combination is possible
- more dimmers combination is not allowed
- in accordance with EN 60669-1 and EN 60669-2-1
- plug-in contacts 1.5mm²
- supply 230V~ 50Hz
- electronic fuse

EE15, EE16

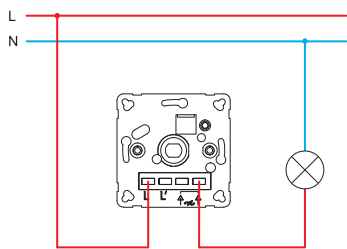

EE15, EE16

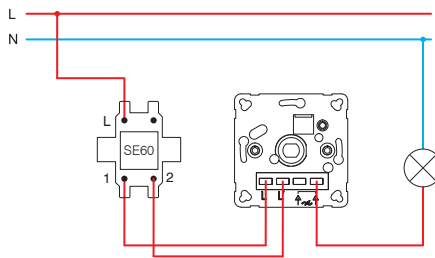

EE15, EE16

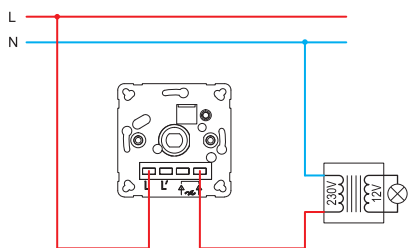

EE15, EE16

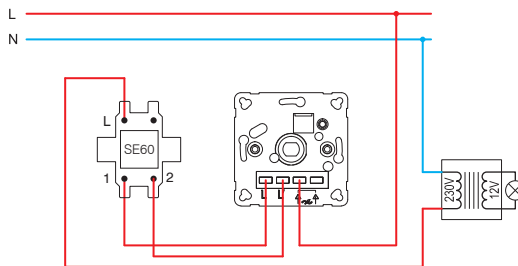

EE16

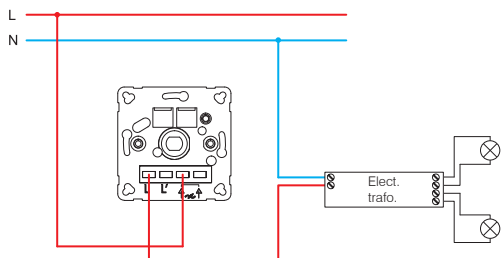

EE16

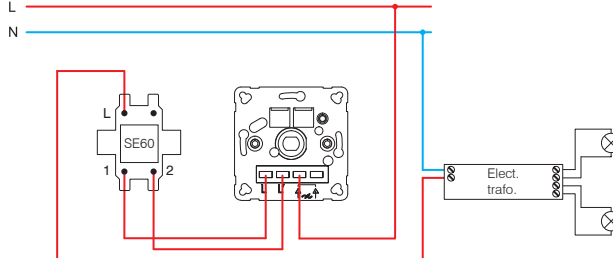

EE17

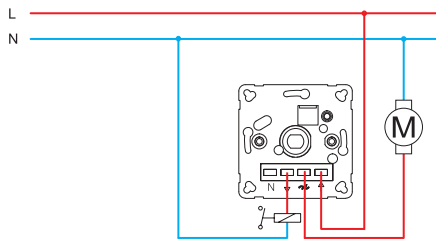

EE15 (40÷400W)

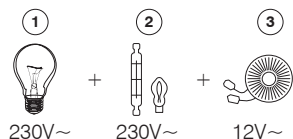

EE16 (20÷400W)

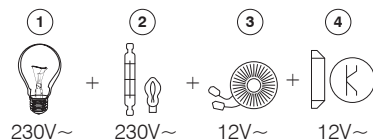

- 1 - Glühlampe / incandescent lamp
- 2 - Halogenlampe / halogen lamp
- 3 - klassischer Transformator / classical transformer
- 4 - elektronischer Transformator / electronic transformer

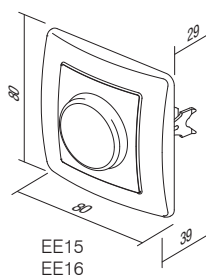
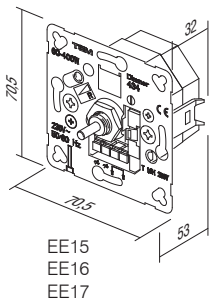



PE40

PW

Typ type	Bezeichnung description	Farbe colour
PE40	DECKEL FÜR DIMMER COVER DIMMER	<input type="checkbox"/> PW Weiß-glänzend <i>polar white</i> <input type="checkbox"/> IW Beige-glänzend <i>ivory white</i> <input type="checkbox"/> ES Silber-matt <i>elox silver</i> <input type="checkbox"/> CO Weiß, Duroplast <i>white thermoset</i> <input type="checkbox"/> NB Schwarz-glänzend <i>night black</i>

DECKEL FÜR DIMMER Ø4



- PE40PW
- PE40IW
- PE40ES
- PE40CO
- PE40NB

- Deckel für Dimmer Ø4 mm
- für EE17

COVER DIMMER Ø4
- cover dimmer Ø4mm
- for EE17



DECKEL FÜR DIMMER Ø6



- PE41PW
- PE41IW
- PE41ES
- PE41CO
- PE41NB

- Deckel für Dimmer Ø6 mm
- für EE15, 16, 18

COVER DIMMER Ø6
- cover dimmer Ø6mm
- for EE15, 16, 18

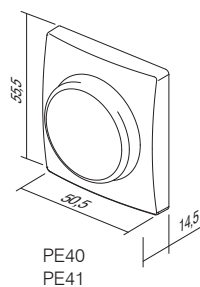

PE40
PE41



AE10

PW

Typ type	Bezeichnung description	Farbe colour
AE10	BLLENDE BLANK	<input type="checkbox"/> PW Weiß-glänzend polar white
AE20	KAMMERANSCHLUSSDOSE 3P+N+E 5X4mm ² CONNECTION BOX 3P+N+E 5X4mm ²	<input type="checkbox"/> IW Beige-glänzend ivory white
AE30	AUFPUTZGEHÄUSE NO 1 SURFACE MOUNT BOX	<input type="checkbox"/> ES Silber-matt elox silver
.	.	<input type="checkbox"/> CO Weiß, Duroplast white thermoset
.	.	<input checked="" type="checkbox"/> NB Schwarz-glänzend night black

BLLENDE



- AE10PW
- AE10IW
- AE10ES
- AE10CO
- AE10NB

- zum Abdecken von leeren Öffnungen

BLANK

- for filling up empty spaces

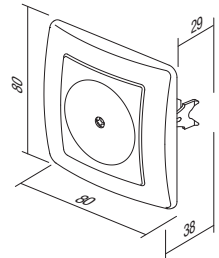

KAMMERANSCHLUSSDOSE 3P+N+E 5x4 mm²



- AE20PW
- AE20IW

- 3P+N+E-Anschluss

- 16A 400V~

- entspricht VDE 0601-1:2000

- Schraubklemmen 1,5-4 mm²

CONNECTION BOX 5POLE 3P+N+E 5x4mm²

- 3P+N+E connection box

- 16A 400V~

- in accordance with VDE 0606-1:2000

- screw contacts 1.5-4mm²

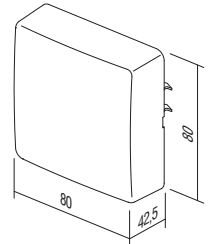

AUFPUTZGEHÄUSE NO 1

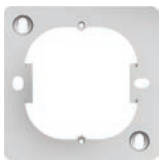

- AE30PW
- AE30IW

- Aufputzgehäuse

SURFACE MOUNT BOX 1

- surface mounting box

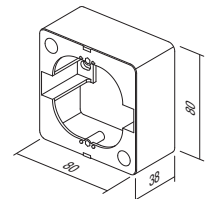



- AE50PW
- AE50TS

TAPETENSCHUTZ

- Dekor-Tapetenschutz

WALL PROTECTION

- protects surface around socket or switch

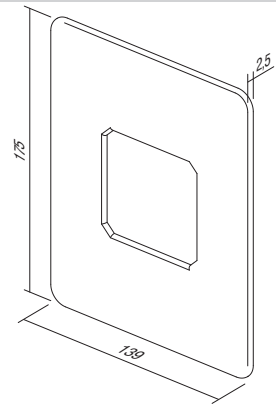

- AE51PW
- AE51W

KINDERSCHUTZ KS

- KS-Kinderschutz gegen Berührung stromführender Teile

CHILD PROTECTION KS

- KS additional child protection insert - shuttered live contacts

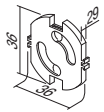



OE10

PW

Typ type	Bezeichnung description	Farbe colour
OE10	RAHMEN EKONOMIK 1 SURROUND EKONOMIK 1	<input type="checkbox"/> PW Weiß-glänzend polar white
OE20	RAHMEN EKONOMIK 2 HORIZONTAL SURROUND EKONOMIK 2 HORIZONTAL	<input type="checkbox"/> IW Beige-glänzend ivory white
OE30	RAHMEN EKONOMIK 3 HORIZONTAL SURROUND EKONOMIK 3 HORIZONTAL	<input type="checkbox"/> ES Silber-matt elox silver
		<input type="checkbox"/> CO Weiß, Duroplast white thermoset
		<input type="checkbox"/> NB Schwarz-glänzend night black

RAHMEN EKONOMIK 1



- OE10PW
- OE10IW
- OE10ES
- OE10CO
- OE10NB

- dekorativer Rahmen 1-fach
- entspricht EN 60669-1
SURROUND EKONOMIK 1
- decorative surround 1-gang
- in accordance with EN 60669-1

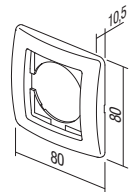

RAHMEN EKONOMIK 2 HORIZONTAL



- OE20PW
- OE20IW
- OE20ES
- OE20CO
- OE20NB

- dekorativer Rahmen 2-fach horizontal
- entspricht EN 60669-1
SURROUND EKONOMIK 2 HORIZONTAL
- decorative surround 2-gang horizontal
- in accordance with EN 60669-1

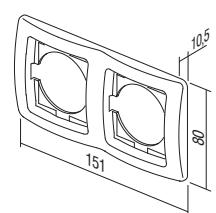

RAHMEN EKONOMIK 2 VERTIKAL



- OE21PW
- OE21IW
- OE21ES
- OE21CO
- OE21NB

- dekorativer Rahmen 2-fach vertikal
- entspricht EN 60669-1
SURROUND EKONOMIK 2 VERTICAL
- decorative surround 2-gang vertical
- in accordance with EN 60669-1

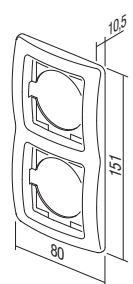

RAHMEN EKONOMIK 3 HORIZONTAL



- OE30PW
- OE30IW
- OE30ES
- OE30CO
- OE30NB

- dekorativer Rahmen 3-fach horizontal
- entspricht EN 60669-1
SURROUND EKONOMIK 3 HORIZONTAL
- decorative surround 3-gang horizontal
- in accordance with EN 60669-1

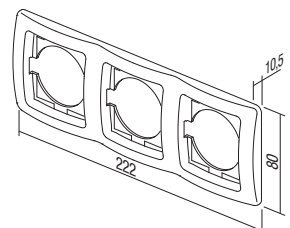



- OE31PW
- OE31IW
- OE31ES
- OE31CO
- OE31NB

RAHMEN EKONOMIK 3 VERTIKAL

- dekorativer Rahmen 3-fach vertikal
- entspricht EN 60669-1

SURROUND EKONOMIK 3 VERTICAL

- decorative surround 3-gang vertical
- in accordance with EN 60669-1

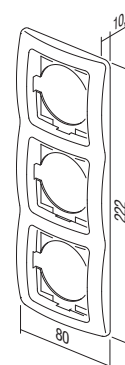

- OE40PW
- OE40IW
- OE40ES
- OE40NB

RAHMEN EKONOMIK 4 HORIZONTAL

- dekorativer Rahmen 4-fach horizontal
- entspricht EN 60669-1

SURROUND EKONOMIK 4 HORIZONTAL

- decorative surround 4-gang horizontal
- in accordance with EN 60669-1

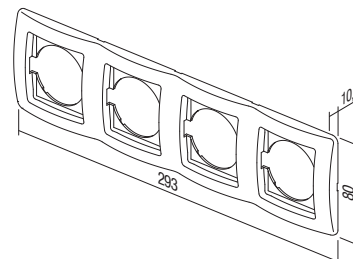

- OE41PW
- OE41IW
- OE41ES
- OE41NB

RAHMEN EKONOMIK 4 VERTIKAL

- dekorativer Rahmen 4-fach vertikal
- entspricht EN 60669-1

SURROUND EKONOMIK 4 VERTICAL

- decorative surround 4-gang vertical
- in accordance with EN 60669-1



DEKORATIVE RAHMEN COLOUR / COLOUR DECORATIVE FRAMES



- OE90GR GRÜN / GREEN
- OE90BL BLAU / BLUE
- OE90VO VIOLETT / VIOLET
- OE90PI ROSA / PINK
- OE90RD ROT / RED
- OE90YL GELB / YELLOW
- OE90WH WEIß / WHITE
- OE90GY GRAU / GREY
- OE90BK SCHWARZ / BLACK
- OE90BR BRAUN / BROWN

- OE90MB MET. BLAU / MET. BLUE
- OE90BZ BRONZE / BRONZE
- OE90CR SILBER / SILVER
- OE90GO GOLD / GOLD



TEM



KATALOG / CATALOGUE

fontana



SCHALTER SF
SWITCHES SF



190

STECKDOSEN VF
SOCKETS VF



192

SETS CF
SETS CF



193

ZUBEHÖR AF
ACCESSORIES AF



195



SF10

PW

TI

Typ type	Bezeichnung description	Technische daten technical data	Farbe colour	Optionsbezeichnung 1 optional data 1
SF10	SCHALTER 1-POLIG SWITCH 1WAY	IP44 10AX 250V~	<input type="checkbox"/> PW Weiß white	TI Glühlampe+Indikator neon lamp+indication
SF11	TASTER 1-POLIG PUSH BUTTON 1WAY	IP44 10A 250V~	<input type="checkbox"/> GY Grau-matt grey-mat	
SF20	SCHALTER 2-POLIG SWITCH 2POLE	IP44 10AX 250V~		
...

SCHALTER 1-POLIG IP44 10AX 250V~



- SF10PW
- SF10GY

- 10AX 250V~, Typ SF10
- entspricht EN 60669-1
- Steckklemmen 1,5-2,5 mm²

SWITCH 1WAY IP44 10AX 250V~
- 10AX 250V~, type SF10
- in accordance with EN 60669-1
- plug-in contacts 1.5-2.5mm²

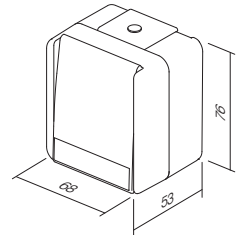

SCHALTER 1-POLIG IP44 10A 250V~ __ TI



- SF10PWTI
- SF10GYTI

- TI Indikator + Glühlampe
- 10AX 250V~, Typ SF10
- entspricht EN 60669-1
- Steckklemmen 1,5-2,5 mm²

SWITCH 1WAY IP44 10AX 250V~ __ TI
- TI indicator+neon lamp
- 10AX 250V~, type SF10
- in accordance with EN 60669-1
- plug-in contacts 1.5-2.5mm²

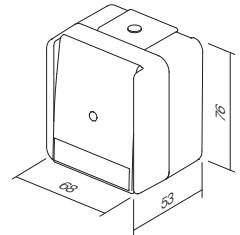

SCHALTER 1-POLIG IP44 10A 250V~ __ TI



- SF11PWTI
- SF11GYTI

- TI Indikator + Glühlampe
- 10A 250V~, Typ SF11
- entspricht EN 60669-1
- Steckklemmen 1,5-2,5 mm²

PUSH BUTTON 1WAY IP44 10A 250V~ __ TI
- TI indicator+neon lamp
- 10A 250V~, type SF11
- in accordance with EN 60669-1
- plug-in contacts 1.5-2.5mm²

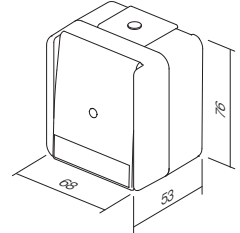

SCHALTER 2-POLIG IP44 10AX 250V~



- SF20PW
- SF20GY

- 10AX 250V~, Typ SF20
- entspricht EN 60669-1
- Steckklemmen 1,5-2,5 mm²

SWITCH 2POLE IP44 10AX 250V~
- 10AX 250V~, type SF20
- in accordance with EN 60669-1
- plug-in contacts 1.5-2.5mm²

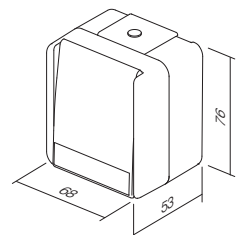

SCHALTER SERIEN IP44 10AX 250V~



- SF50PW
- SF50GY

- 10AX 250V~, Typ SF50
- entspricht EN 60669-1
- Steckklemmen 1,5-2,5 mm²

SWITCH 2GANG-1WAY IP44 10AX 250V~

- 10AX 250V~, type SF50
- in accordance with EN 60669-1
- plug-in contacts 1.5-2.5mm²

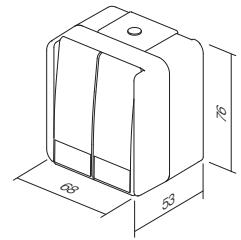

TASTER SERIEN IP44 10A 250V~



- SF51PW
- SF51GY

- 10A 250V~, Typ SF51
- entspricht EN 60669-1
- Steckklemmen 1,5-2,5 mm²

PUSH BUTTON 2GANG-1WAY IP44 10A 250V~

- 10A 250V~, type SF51
- in accordance with EN 60669-1
- plug-in contacts 1.5-2.5mm²

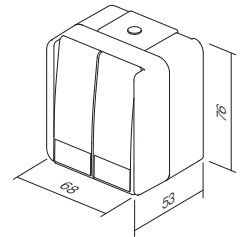

SCHALTER WECHSEL IP44 10AX 250V~



- SF60PW
- SF60GY

- 10AX 250V~, Typ SF60
- entspricht EN 60669-1
- Steckklemmen 1,5-2,5 mm²

SWITCH 2WAY IP44 10AX 250V~

- 10AX 250V~, type SF60
- in accordance with EN 60669-1
- plug-in contacts 1.5-2.5mm²

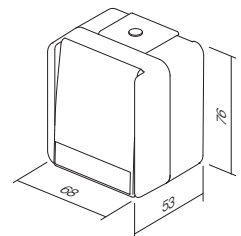

SCHALTER WECHSEL IP44 10AX 250V~ __ TI



- SF60PWTI
- SF60GYTI

- TI Indikator + Glühlampe
- 10AX 250V~, Typ SF60
- entspricht EN 60669-1
- Steckklemmen 1,5-2,5 mm²

SWITCH 2WAY IP44 10AX 250V~ __ TI

- TI indicator+neon lamp
- 10AX 250V~, type SF60
- in accordance with EN 60669-1
- plug-in contacts 1.5-2.5mm²

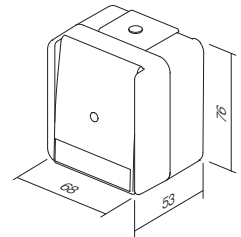

SCHALTER DOPPELT AUS/WECHSEL 10AX 250V~



- SF63PW
- SF63GY

- 10AX 250V~, Typ SF63
- entspricht EN 60669-1
- Steckklemmen 1,5-2,5 mm²

SWITCH 2WAY DOUBLE IP44 10AX 250V~

- 10AX 250V~, type SF63
- in accordance with EN 60669-1
- plug-in contacts 1.5-2.5mm²

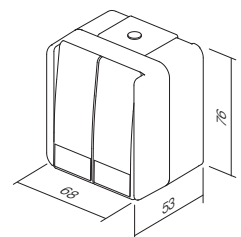

SCHALTER KREUZ IP44 10AX 250V~



- SF70PW
- SF70GY

- 10AX 250V~, Typ SF70
- entspricht EN 60669-1
- Steckklemmen 1,5-2,5 mm²

SWITCH INTERMEDIATE IP44 10AX 250V~

- 10AX 250V~, type SF70
- in accordance with EN 60669-1
- plug-in contacts 1.5-2.5mm²

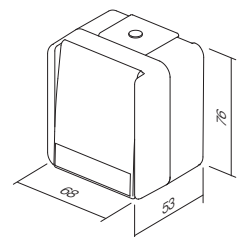



VF10

PW

Typ type	Bezeichnung description	Technische daten technical data	Farbe colour
VF10	STECKDOSE SCHUKO+ KLAPPDECKEL SOCKET SCHUKO+COVER	IP44 2P+E 16A 250V~	<input type="checkbox"/> PW Weiß-matt white-mat <input type="checkbox"/> GY Beige-matt grey-mat

STECKDOSE SCHUKO+KLAPPDECKEL IP44 2P+E 16A 250V~



- VF10PW
- VF10GY

- Schraubklemmen 1,5-2,5 mm²
- Steckdose mit Schutzkontakt mit Klappdeckel
- 16A 250V~, Typ VF10
- entspricht IEC 60884-1, CEE7

SOCKET SCHUKO+COVER IP44 2P+E 16A 250V~

- screw contacts 1.5-2.5mm²
- 2P+E schuko+cover
- 16A 250V~, type VF10
- in accordance with EN 60884-1, CEE7

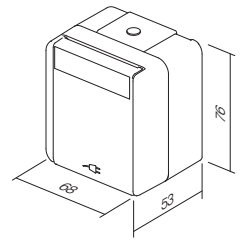

STECKDOSE SCHUKO+DECKEL IP44 2P+E 16A 250V~ BV



- VF12PW
- VF12GY

- BV Steckklemmen 1,5-2,5 mm²
- Steckdose mit Schutzkontakt mit Klappdeckel
- 16A 250V~, Typ VF12
- entspricht IEC 60884-1, CEE7

SOCKET SCHUKO+COVER IP44 2P+E 16A 250V~ BV

- BV plug-in contacts 1.5-2.5mm²
- 2P+E schuko+cover
- 16A 250V~, type VF12
- in accordance with EN 60884-1, CEE7

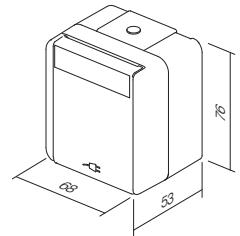



CF11

PW

Typ type	Bezeichnung description	Technische daten technical data	Farbe colour
CF10	SET STECKDOSE SCHUKO DOPPELT HORIZONTAL SOCKET SET SCHUKO DOUBLE HORIZ	2x 2P+E 16A 250V~ IP44	<input type="checkbox"/> PW Weiß-matt white-mat <input type="checkbox"/> GY Beige-matt grey-mat
CF11	SET STECKDOSE SCHUKO DOPPELT VERTIKAL SOCKET SET SCHUKO DOUBLE VERT	2x 2P+E 16A 250V~ IP44	
CF12	SET STECKDOSE SCHUKO + SCHALTER WECHSEL HORIZ SOCKET SCH+SWITCH 2WAY HORIZ	16A + 10A 250V~ IP44	
.	.	.	.

SET STECKDOSE SCHUKO DOPPELT HORIZONTAL IP44 2x 2P+E 16A 250V~



- CF10PW
 CF10GY

- Schraubklemmen 1,5-2,5 mm²
- 2x Steckdose mit Schutzkontakt mit Klappdeckel horizontal
- 16A 250V~, Typ CF10
- entspricht IEC 60884-1, CEE7

SOCKET SET SCHUKO DOUBLE HORIZONTAL IP44 2x 2P+E 16A 250V~

- screw contacts 1.5-2.5mm²
- 2x 2P+E schuko+cover horizontal
- 16A 250V~, type CF10
- in accordance with EN 60884-1, CEE7

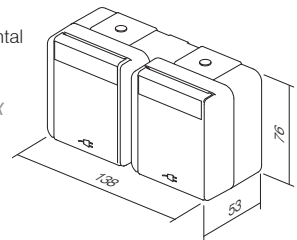

SET STECKDOSE SCHUKO DOPPELT VERTIKAL IP44 2x 2P+E 16A 250V~



- CF11PW
 CF11GY

- Schraubklemmen 1,5-2,5 mm²
- 2x Steckdose mit Schutzkontakt mit Klappdeckel vertikal
- 16A 250V~, Typ CF11
- entspricht IEC 60884-1, CEE7

SOCKET SET SCHUKO DOUBLE VERTICAL IP44 2x 2P+E 16A 250V~

- screw contacts 1.5-2.5mm²
- 2x 2P+E schuko+cover vertical
- 16A 250V~, type CF11
- in accordance with EN 60884-1, CEE7

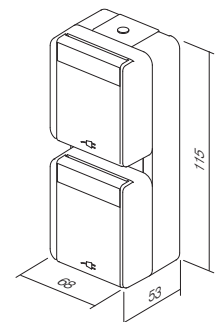

SET STECKDOSE SCHUKO+SCHALTER WECHSEL HORIZONTAL IP44 16A + 10AX 250V~



- CF12PW
 CF12GY

- Schraubklemmen (Steckdose), Steckklemmen (Schalter) 1,5-2,5 mm²
- Steckdose mit Schutzkontakt mit Klappdeckel + Wechselschalter horizontal
- 16A + 10AX 250V~, Typ CF12
- entspricht EN 60884-1, CEE7, EN 60669-1

SOCKET SCH+SWITCH SET 2WAY HORIZONTAL IP44 16A + 10AX 250V~

- screw (socket), plug-in (switch) contacts 1.5-2.5mm²
- 2P+E schuko+cover + switch 2-way horizontal
- 16A + 10AX 250V~, type CF12
- in accordance with EN 60884-1, CEE7, EN 60669-1

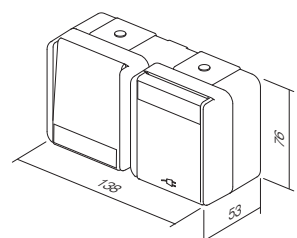

SET STECKDOSE SCHUKO+SCHALTER WECHSEL VERTIKAL IP44 16A + 10AX 250V~



- CF13PW
- CF13GY

- Schraubklemmen (Steckdose), Steckklemmen (Schalter) 1,5-2,5 mm²
 - Steckdose mit Schutzkontakt mit Klappdeckel + Wechselschalter vertikal
 - 16A + 10AX 250V~, Typ CF13
 - entspricht EN 60884-1, CEE7, EN 60669-1

SOCKET SCH+SWITCH 2WAY SET VERTICAL
IP44 16A + 10AX 250V~

- screw (socket), plug-in (switch)
 - contacts 1.5-2.5mm²
 - 2P+E schuko+cover + switch 2-way vertical
 - 16A + 10AX 250V~, type CF13
 - in accordance with EN 60884-1, CEE7, EN 60669-1

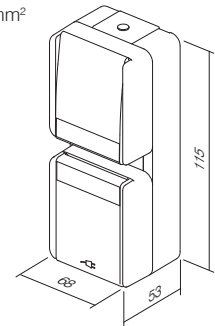

SET STECKDOSE SCHUKO DOPPELT HORIZONTAL IP44 2x 2P+E 16A 250V~BV



- CF14PW
- CF14GY

- BV Steckklemmen 1,5-2,5 mm²
 - 2x Steckdose mit Schutzkontakt mit Klappdeckel horizontal
 - 16A 250V~, Typ CF14
 - entspricht IEC 60884-1, CEE7

SOCKET SET SCHUKO DOUBLE HORIZONTAL IP44 2x
2P+E 16A 250V~ BV

- BV plug-in contacts 1.5-2.5mm²
 - 2x 2P+E schuko+cover horizontal
 - 16A 250V~, type CF14
 - in accordance with EN 60884-1, CEE7

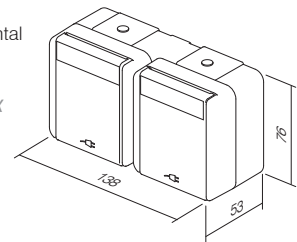

SET STECKDOSE SCHUKO DOPPELT VERTIKAL IP44 2x 2P+E 16A 250V~ BV



- CF15PW
- CF15GY

- BV Steckklemmen 1,5-2,5 mm²
 - 2x Steckdose mit Schutzkontakt mit Klappdeckel vertikal
 - 16A 250V~, Typ CF15
 - entspricht IEC 60884-1, CEE7

SOCKET SET SCHUKO DOUBLE VERTICAL
IP44 2x 2P+E 16A 250V~ BV

- BV plug-in contacts 1.5-2.5mm²
 - 2x 2P+E schuko+cover vertical
 - 16A 250V~, type CF15
 - in accordance with EN 60884-1, CEE7

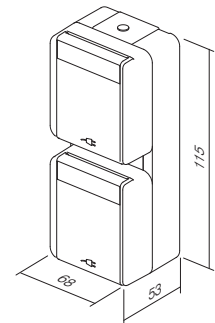

SET STECKDOSE SCHUKO+SCHALTER WECHSEL HORIZONTAL IP44 16A + 10AX 250V~ BV



- CF16PW
- CF16GY

- BV Steckklemmen 1,5-2,5 mm²
 - Steckdose mit Schutzkontakt mit Klappdeckel + Wechselschalter horizontal
 - 16A + 10AX 250V~, Typ CF16
 - entspricht EN 60884-1, CEE7, EN 60669-1

SOCKET+SWITCH SET SCH+2WAY HORIZONTAL
IP44 16A + 10AX 250V~ BV

- BV plug-in contacts 1.5-2.5mm²
 - 2P+E schuko+cover + switch 2-way horizontal
 - 16A + 10AX 250V~, type CF16
 - in accordance with EN 60884-1, CEE7, EN 60669-1

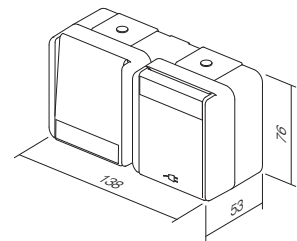

SET STECKDOSE SCHUKO+SCHALTER WECHSEL VERTIKAL IP44 16A + 10AX 250V~ BV



- CF17PW
- CF17GY

- BV Steckklemmen 1,5-2,5 mm²
 - Steckdose mit Schutzkontakt mit Klappdeckel + Wechselschalter vertikal
 - 16A + 10AX 250V~, Typ CF17
 - entspricht EN 60884-1, CEE7, EN 60669-1

SOCKET SCH+SWITCH 2WAY SET VERTICAL
IP44 16A + 10AX 250V~ BV

- BV plug-in contacts 1.5-2.5mm²
 - 2P+E schuko+cover + switch 2-way vertical
 - 16A + 10AX 250V~, type CF17
 - in accordance with EN 60884-1, CEE7, EN 60669-1

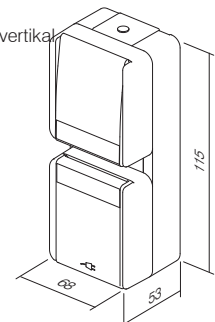

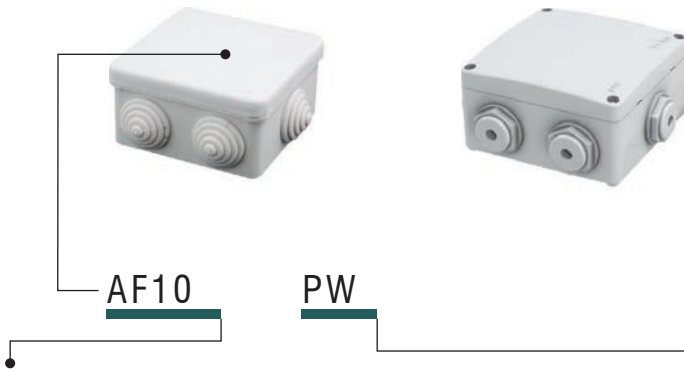

Typ type	Bezeichnung description	Technische Daten technical data	Farbe colour
AF10	ABZWEIGKASTEN DISTRIBUTION BOX	IP44 RN01	<input type="checkbox"/> PW Weiß-matt white-mat
AF20	ABZWEIGKASTEN DISTRIBUTION BOX	IP55 ND01	<input type="checkbox"/> GY Beige-matt grey-mat

ABZWEIGKASTEN IP44 RN01



- AF10PW - Aufputzabzweigkasten IP44
- 16A 400V~
- entspricht EN 60309-1
- AF10GY

DISTRIBUTION BOX IP44 RN01
 - surface mounting distribution box IP44
 - 16A 400V~
 - in accordance with EN 60309-1

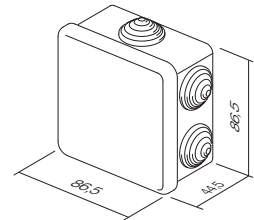

ABZWEIGKASTEN IP55 ND01



- AF20PW - Aufputzabzweigkasten IP55
- inkl. Einführungen
- entspricht EN 60309-1
- AF20GY

DISTRIBUTION BOX IP55 ND01
 - surface mounting connection box IP55
 - glands included
 - in accordance with EN 60309-1

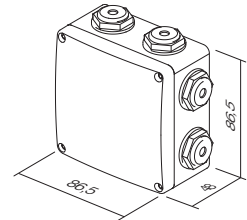

MODUL 

Typ	Bezeichnung	Seite
SCHALTER SM		
SM10	SCHALTER 1-POLIG 16AX 250V~ 1M	54
SM11	TASTER 1-POLIG 16A 250V~ 1M	54
SM12	SCHALTER 1-POLIG 20A 250V~ 1M	54
SM20	SCHALTER 2-POLIG 16AX 250V~ 1M	54
SM40	SCHALTER JALOUSIE 1-0-2 16AX 250V~ 1M	55
SM41	TASTER JALOUSIE 1-0-2 16A 250V~ 1M	55
SM60	SCHALTER WECHSEL 16AX 250V~ 1M	55
SM61	TASTER WECHSEL 16A 250V~ 1M	55
SM70	SCHALTER KREUZ 16AX 250V~ 1M	55
SM10--	SCHALTER 1-POLIG 16AX 250V~ 1M	56
SM10--IN	SCHALTER 1-POLIG 16AX 250V~ 1M IN	56
SM11--	TASTER 1-POLIG 16A 250V~ 1M	56
SM11--IN01	TASTER 1-POLIG 16A 250V~ 1M IN 01	56
SM11--IN02	TASTER 1-POLIG 16A 250V~ 1M IN 02	57
SM20--NT03	SCHALTER 2-POLIG 16AX 250V~ 1M NT 03	57
SM20--IN	SCHALTER 2-POLIG 16AX 250V~ 1M IN	57
SM40--NT10	SCHALTER JALOUSIE 1-0-2 16AX 250V~ 1M NT 10	57
SM41--NT10	TASTER JALOUSIE 1-0-2 16A 250V~ 1M NT 10	57
SM60--	SCHALTER WECHSEL 16AX 250V~ 1M	57
SM61--	TASTER WECHSEL 16A 250V~ 1M	58
SM62-CD	TASTER WECHSEL MIT SCHNUR 16A 250V~ 1M CD	58
SM70--	SCHALTER KREUZ 16AX 250V~ 1M	58
WIPPEN TM		
TM11--	WIPPE 1M	59
TM11--IN	WIPPE 1M IN	59
TM12--	WIPPE 2M	59
TM12--IN	WIPPE 2M IN	59
TM13--IL	WIPPE MIT NAMENSCHILD 2M	60
TM15--	WIPPE 1M 2-POLIG	60
TM21--	BLLENDE 1M	60
TM22--	BLLENDE 2M	60
TM31--	KABELEINFÜHRUNG 1M	60
BELEUCHTUNG IA		
IA10--	GLÜHLAMPE 230V~ 0,34 W	62
IA20--	LED-LAMPE 230V AC/DC 0,40 W	62
IA21--	LED-LAMPE 24V AC/DC 0,20 W	62
IA22--	LED-LAMPE 12V AC/DC 0,10 W	62
STECKDOSEN VM		
VM10--	STECKDOSE SCHUKO+KS 2P+E 16A 250V~ 2M	64
VM11--	STECKDOSE SCHUKO+KS+KLAPPDECKEL 2P+E 16A 250V~ 2M	64
VM20--	STECKDOSE EURO+KS 2P 10A 250V~ 1M	65
VM40--	STECKDOSE FRANZÖSISCH+KS 2P+E 16A 250V~ 2M	65
VM41--	STECKDOSE FRANZÖSISCH+KS+KLAPPDECKEL 2P+E 16A 250V~ 2M	65
VM30--	STECKDOSE ITALIENISCH P17/11+KS 2P+E 16A 250V~ 1M	65
VM31--	STECKDOSE SCHUKO/ITALIENISCH P17/11+KS 2P+E 16A 250V~ 2M	65
VM32--	STECKDOSE SCHUKO/ITALIENISCH P30+KS 2P+E 16A 250V~ 2M	66
VM33--	STECKDOSE ITALIENISCH P11+KS 2P+E 10A 250V~ 1M	66
VM21--	STECKDOSE EURO/AMERIKANISCH+KS 2P 16A 250V~ 1M	66
VM51--	STECKDOSE BRITISCH BS546+KS 2P+E 15A 250V~ 2M	66
VM52--	STECKDOSE BRITISCH BS 1363-2+KS 2P+E 13A 250V~ 2M	66
VM80	ÜBERSpannungsschutz MPE MINI 275V/50Hz	66
KOMMUNIKATION KM		
KM10--	STECKDOSE TV-EINZELDOSE 0dB 1M	68
KM20--	STECKDOSE TV-EINZELDOSE 0dB 2M	68
KM11--	STECKDOSE TV-ENDDOSE 1dB 1M	68
KM12--	STECKDOSE TV-DURCHGANGSDOSE 10dB 1M	68
KM15--	STECKDOSE SAT-EINZELDOSE 0dB 1M	69
KM24--	STECKDOSE SAT-EINZELDOSE 0dB 2M	69
KM16--	STECKDOSE SAT-ENDDOSE 1dB 1M	69
KM19--	STECKDOSE R EINZELDOSE 0dB 1M	69
KM29--	STECKDOSE R-EINZELDOSE 0dB 2M	69
KM25--	STECKDOSE SAT-TV-ENDDOSE 1dB 2M	69
KM22--	STECKDOSE AUDIO 2xRCA 1M	70
KM23--	STECKDOSE AUDIO FÜR LAUTSPRECHER 1M	70
KM30--	STECKDOSE TEL LT RJ11 6/4 1M	71
KM31--	STECKDOSE TEL BT SEC 6/6 1M	71
KM36--	STECKDOSE TEL KS RJ11 6/4 1M	71
KM37--	STECKDOSE CAT5e KS RJ45 8/8 1M	71
KM35--	ADAPTER KS 1M	71
KM38--	ADAPTER KS MIT STAUBSCHUTZ 1M	71
KM50--	ADAPTER KS UNIVERSAL 1M	72
KM40--	ADAPTER PD 1M	72
KM43--	ADAPTER PD MIT STAUBSCHUTZ 1M	72
KM46--	ADAPTER R&M 1M	72
KM47--	ADAPTER R&M MIT STAUBSCHUTZ 1M	72
KM45--	ADAPTER LK 1M	72
KA26	ADAPTER NEXANS (N423.540N) 2M	73
KA48--	ADAPTER AT&T SYSTIMAX MIT STAUBSCHUTZ 1M	73

Typ	Bezeichnung	Seite
KOMMUNIKATIONSZUBEHÖR KA		
KA10	KONNEKTOR KS CAT3 RJ11 6/4	74
KA11	KONNEKTOR KS CAT5e RJ45 8/8	74
KA12	KONNEKTOR KS CAT5eS RJ45 8/8	74
KA15	KONNEKTOR KS CAT6 SCHRACK RJ45 8/8	74
KA16	KONNEKTOR KS CAT6S SCHRACK RJ45 8/8	74
KA17	KONNEKTOR KS CAT6a SCHRACK RJ45 8/8	74
KA27	KONNEKTOR KS HDMI	75
ELEKTRONIK EM		
EM10--	DIMMER DREH-AUS R 300W 1M	76
EM11--	DIMMER DREH-WECHSEL RL 300W 1M	76
EM21	DIMMER EINBAU RLC 300W	77
EM22	DIMMER EINBAU R 500W	77
EM25--	SCHALTER/DIMMER UNIVERSAL RLC 0-300W 2M	78
EM26--	KONTROLLTASTER 2M	80
EM27	STÖRUNGSFILTER	80
EM25PPOL20	SET SCHALTER/DIMMER UNIVERSAL RLC 0-300W 2M PP OL20	80
EM31--	IR-SCHALTER 5A 250V~ 1M	81
EM35--	ELEKTRONISCHES CHRONOTHERMOSTAT 6A 250V~ 2M	82
EM40--	KARTENSCHALTER 3A 250V~ 3M	83
EM41--	ENERGIESPAR-KARTENSCHALTER BARCODE 3M	83
EM43--	KARTENSCHALTER RF HF 13,56MHz 12-24V 3M	83
EM47	KARTE ISO BARCODE	83
EM48	RELAISEINHEIT FÜR KARTENSCHALTER 2x16A 250V~	84
EM60--	RASIERSTECKDOSE 230V~/125V~ 3M	84
EM65--	LADEGERÄT USB 5V 1A 2M	84
EM55	LED-NOTLEUCHE 250V~ 1,5W, NiMH 6h 7M	85
EM50--	LED-LAMPE EINFARBIG 250V~ 12W 2M	85
EM51--	LED-LAMPE ZWEIFARBIG 250V~ 2x6W 2M	85
EM52--	3D-LED-LAMPE ZWEIFARBIG 230V~ 2x6W 2M	85
EM70--	FINGERABDRUCKLESER ARX ONE 2M	86
EM90--	SUMMER 8VA 220V~ 1M	87
EM91--	SUMMER 8VA 12V 1M	87
EM92--	KLINGEL 8VA 220V~ 1M	87
EM93--	KLINGEL 8VA 12V 1M	87
EM95--	LAUTSTÄRKENREGLER FÜR 100 V AUDIOLINIE 35W 2M	88
EM96--	NIEDEROHMIGER LAUTSTÄRKENREGLER 4-8 Ω 35W 2M	88
SETS CM		
CM10--	SET STECKDOSEN 2x SCHUKO 2P+E 16A 250V~ 4M	89
CM11--	SET STECKDOSEN 3x SCHUKO 2P+E 16A 250V~ 7M	89
CM15	SET VERDRAHTUNGBRÜCKEN FARBIG 3x1,5mm ² 1M	90
CM16	SET VERDRAHTUNGBRÜCKEN FARBIG 3x2,5mm ² 2M	90
CM17	SET SCHRAUBEN 3,5x20	90
CM18	SET SCHRAUBEN 3,5x35	90
CM19	SET SCHRAUBEN 3,5x50	90
CM22--	SCHALTER-SET IP44 2M	90
CM23	SCHALTER-SET IP44 2M	90
CM25--OL	BADEZIMMERSET 3x20AX 250V~ 4M OL	90
CM25--OS	BADEZIMMERSET 3x20AX 250V~ 4M OS	90
NM41	MONTAGETRÄGER FÜR BADEZIMMERSET 4M	91
OL41--	RAHMEN LINE FÜR BADEZIMMERSET	91
OS41--	RAHMEN SOFT FÜR BADEZIMMERSET	91
ANTIBAKTERIENPROGRAMM AW		
TM11AW	WIPPE 1M	93
TM11AWIN	KONTROLLWIPPE 1M	93
TM12AW	WIPPE 2M	93
TM12AWIN	KONTROLLWIPPE 2M	93
TM21AW	BLLENDE 1M	93
TM22AW	BLLENDE 2M	93
VM10AW	STECKDOSE SCHUKO+KS 2P+E 16A 250V~ 2M	94
VM11AW	STECKDOSE SCHUKO+KS+KLAPPDECKEL 2P+E 16A 250V~ 2M	94
VM20AW	STECKDOSE EURO+KS 2P 10A 250V~ 1M	94
KM11AW	TV-ENDDOSE 1dB 1M	94
KM35AW	ADAPTER KS 1M	94
OS20AW	RAHMEN SOFT 2M	95
OS24AW	RAHMEN SOFT 2x2M	95
OS26AW	RAHMEN SOFT 3x2M	95
OS30AW	RAHMEN SOFT 3M	95
OS40AW	RAHMEN SOFT 4M	95
OS70AW	RAHMEN SOFT 7M	95
RAHMEN PURE OP		
OP20--	RAHMEN PURE 2M	98
OP24--	RAHMEN PURE 2x2M	98
OP26--	RAHMEN PURE 3x2M	98
OP30--	RAHMEN PURE 3M	99
OP40--	RAHMEN PURE 4M	99
OP70--	RAHMEN PURE 7M	99
OP13--	RAHMEN PURE 1/3M	99
OP23--	RAHMEN PURE 2/3M	99

I N D E X

Typ	Bezeichnung	Seite
RAHMEN LINE OL		
OL20--	RAHMEN LINE 2M	102
OL24--	RAHMEN LINE 2x2M	102
OL26--	RAHMEN LINE 3x2M	102
OL28--	RAHMEN LINE 4x2M	102
OL30--	RAHMEN LINE 3M	103
OL40--	RAHMEN LINE 4M	103
OL70--	RAHMEN LINE 7M	103
OL10--	RAHMEN LINE 1M	103
OL13--	RAHMEN LINE 1/3M	103
OL23--	RAHMEN LINE 2/3M	103
RAHMEN SOFT OS		
OS20--	RAHMEN SOFT 2M	106
OS24--	RAHMEN SOFT 2x2M	106
OS26--	RAHMEN SOFT 3x2M	106
OS28--	RAHMEN SOFT 4x2M	106
OS30--	RAHMEN SOFT 3M	107
OS40--	RAHMEN SOFT 4M	107
OS70--	RAHMEN SOFT 7M	107
OS10--	RAHMEN SOFT 1M	107
OS13--	RAHMEN SOFT 1/3M	107
OS23--	RAHMEN SOFT 2/3M	107
MONTAGETRÄGER NM		
NM20	MONTAGETRÄGER MIT KRALLEN 2M	112
NM21	MONTAGETRÄGER OHNE SCHRAUBEN 2M	112
NM24	MONTAGETRÄGER METALL MIT KRALLEN 2M	112
NM25	MONTAGETRÄGER METALL OHNE SCHRAUBEN 2M	112
NM30	MONTAGETRÄGER MIT SCHRAUBEN 3M	113
NM40	MONTAGETRÄGER MIT SCHRAUBEN 4M	113
NM70	MONTAGETRÄGER MIT SCHRAUBEN 7M	113
NM72	MONTAGETRÄGER MIT SCHRAUBEN 2x7M	113
NM10	MONTAGETRÄGER MIT KRALLEN 1/2M	114
NM11	MONTAGETRÄGER OHNE SCHRAUBEN 1/2M	114
NM23	MONTAGETRÄGER METALL MIT KRALLEN 2/3M	114
NM32	MONTAGETRÄGER MIT SCHRAUBEN 2/3M	114

Dosen

Typ	Bezeichnung	Seite
RUNDDOSEN		
DE10	RUNDDOSE FLACH ZIEGELWAND SM60-01	118
DE11	RUNDDOSE ZIEGELWAND TIEF SM60-06	118
DE30	ABSTANDSTUTZEN SM60-03	118
DE31	ABSTANDSTUTZEN SM60-04	118
DE12	RUNDDOSE ZIEGELWAND MD65-46	119
DE13	RUNDDOSE ZIEGELWAND MD65-60	119
DE12	VERLÄNGERUNG RUNDDOSE ZIEGELWAND MD65-46	119
DE32	ABSTANDSTUTZEN MD65-71	119
DE33	ABSTANDSTUTZEN MD65-91	119
DE20	FEDERDECKEL 60	119
DE21	FEDERDECKEL 65	119
DE22	FEDERDECKEL DEKORATIV SM60	119
HE10	RUNDDOSE HOHLWAND SM68x40	122
HE11	RUNDDOSE HOHLWAND SM68x55	122
BE10	RUNDDOSE BETONWAND	122
BE11	RUNDDOSE BETONWAND	122
BE20	GEGENLAGER FÜR RUNDDOSE BETONWAND	122
BE21	ROHREINFÜHRUNGA FÜR RUNDDOSE BETONWAND 16	122
RECHTECKDOSEN		
DM30	RECHTECKDOSE ZIEGELWAND PM3	126
DM31	RECHTECKDOSE ZIEGELWAND PM3-65	126
DM40	RECHTECKDOSE ZIEGELWAND PM4	126
DM41	RECHTECKDOSE ZIEGELWAND PM4-65	126
DM70	RECHTECKDOSE ZIEGELWAND PM7	127
DM71	RECHTECKDOSE ZIEGELWAND PM7-65	127
DM72	RECHTECKDOSE ZIEGELWAND PM72-65	127
DM80	ABSTANDHALTER FÜR RECHTECKDOSEN PM	127
DM33	FEDERDECKEL FÜR RECHTECKDOSE PM3	128
DM34	FEDERDECKEL FÜR RECHTECKDOSE DEKORATIV PM3	128
DM43	FEDERDECKEL FÜR RECHTECKDOSE PM4	128
DM44	FEDERDECKEL FÜR RECHTECKDOSE DEKORATIV PM4	128
DM73	FEDERDECKEL FÜR RECHTECKDOSE PM7	128
DM74	FEDERDECKEL FÜR RECHTECKDOSE DEKORATIV PM7	128
DM75	ABDECKUNG DEKORATIV PM72	129
HM30	RECHTECKDOSE HOHLWAND VM3	130
HM40	RECHTECKDOSE HOHLWAND VM4	130
HM70	RECHTECKDOSE HOHLWAND VM7	130
HM72	RECHTECKDOSE HOHLWAND VM72	130
BM30	RECHTECKDOSE BETONWAND BM3	131
BM40	RECHTECKDOSE BETONWAND BM4	131
BM70	RECHTECKDOSE BETONWAND BM7	131
BM80	BEFESTIGUNGSELEMENT FÜR DOSE BM	131
BM82	DISTANZPROFIL FÜR DOSE BM	131

Typ	Bezeichnung	Seite
ABZWEIGKASTEN		
DW10	ABZWEIGDOSE RUND ZIEGELWAND DSM78	134
HW10	ABZWEIGDOSE RUND HOHLWAND SM78x45	134
DE23	FEDERDECKEL DEKORATIV SM78	134
DE24	FEDERDECKEL 78	134
HW20	ABZWEIGKASTEN QUADRATISCH ZIEGELWAND SM105x105	134
VERDRAHTUNGZUBEHÖR		
UW10--	DOSENKLEMMLEISTEN PA 2x2.5mm ² 12P	136
UW11--	DOSENKLEMMLEISTEN PA 2x4mm ² 12P	136
UW12--	DOSENKLEMMLEISTEN PA 2x6mm ² 12P	136
UW15--	DOSENKLEMMLEISTEN GESCHLOSSEN PC 2x2.5mm ² 10P	136
UW16--	DOSENKLEMMLEISTEN GESCHLOSSEN PC 2x4mm ² 10P	136
UW17--	DOSENKLEMMLEISTEN GESCHLOSSEN PC 2x6mm ² 10P	136
UW20--	LÜSTER-KLEMMLEISTEN PA 1.5mm ² 12P	136
UW21--	LÜSTER-KLEMMLEISTEN PA 2.5mm ² 12P	136
UW22--	LÜSTER-KLEMMLEISTEN PA 4-6mm ² 12P	136
UW23--	LÜSTER-KLEMMLEISTEN PA 10mm ² 12P	136
UW40--	STECKKLEMMEN PA 1.5mm ² 3P	137
UW41--	STECKKLEMMEN PA 1.5mm ² 5P	137
UW42--	STECKKLEMMEN PA 1.5mm ² 8P	137
UW45--	STECKKLEMMEN PA 2.5mm ² 3P	137
UW46--	STECKKLEMMEN PA 2.5mm ² 4P	137
UW47--	STECKKLEMMEN PA 2.5mm ² 5P	137
UW50--	STECKKLEMMEN PA 2.5mm ² 2/1P	137

Vertrieb

Typ	Bezeichnung	Seite
AUFPUTZGEHÄUSE CUBO IP20 AC		
AC10--	AUFPUTZGEHÄUSE NO CUBO IP20 1M	140
AC20--	AUFPUTZGEHÄUSE NO CUBO IP20 2M	140
AC40--	AUFPUTZGEHÄUSE NO CUBO IP20 4M	140
AC60--	AUFPUTZGEHÄUSE NO CUBO IP20 6M	140
AUFPUTZGEHÄUSE CUBO IP55 AQ		
AQ20--	AUFPUTZGEHÄUSE NO CUBO IP55 2M	141
AQ30--	AUFPUTZGEHÄUSE NO CUBO IP55 3M	141
AQ31--	UNTERPUTZGEHÄUSE PO CUBO IP55 3M	141
BRÜSTUNGSKANÄLE ALU MA		
RT10	ADAPTER MA 92	142
RT12--	RAHMEN MA 92 2/3M	142
RT14--	RAHMEN MA 92 4M	142
RT17--	RAHMEN MA 92 7M	142
RT20--	KANALUNTERTEIL MA 130x65	143
RT21--	KANALUNTERTEIL MA 165x65	143
RT25--	FRONTABDECKUNG MA 92	143
RT30	TRENNWAND MA 43	143
RT31	TRENNWAND ALU MA 43	143
RT32	TRENNWAND ALU MA DOPPELT 43	143
RT35--	ENDSTÜCK MA 130x65	144
RT36--	ENDSTÜCK MA 165x65	144
RT38	VERBINDUNGSSTÜCK MA 65	144
RT40--	UNIVERSALECK MA 130x65	144
RT41--	UNIVERSALECK MA 165x65	144
RT42	ERDUNGSKLEMMEN MA 2x A6.3	144
RT43--	FLACHWINKEL MA 130x65	145
RT44--	FLACHWINKEL MA 165x65	145
RT45--	T-STÜCK MA 130x65	145
RT46--	T-STÜCK MA 165x65	145
RT50--	BEFESTIGUNGSPLATTE EINFACH 130x65	146
RT51--	BEFESTIGUNGSPLATTE DOPPELT 2x 130x65	146
RT52--	SERVICISÄULE MA 130x65x500	146
RT53--	SERVICISÄULE MA DOPPELT 130x65x500	146
BODENDOSEN MT		
RB30	BODENDOSE MT 7 H=53mm	148
RB40	BODENDOSE MT 7 H=88mm	148
RB31	UNTERSATZ FÜR BODENDOSEN MT 7 H=53mm	148
RB41	UNTERSATZ FÜR BODENDOSEN MT 7 H=88mm	148
RB33	BODENDOSE MT 14 H=53mm	148
RB43	BODENDOSE MT 14 H=88mm	148
RB34	UNTERSATZ FÜR BODENDOSEN MT 14 H=53mm	149
RB44	UNTERSATZ FÜR BODENDOSEN MT 14 H=88mm	149
RB36	BODENDOSE MT 21 H=53mm	149
RB46	BODENDOSE MT 21 H=88mm	149
RB37	UNTERSATZ FÜR BODENDOSEN MT 21 H=53mm	149
RB47	UNTERSATZ FÜR BODENDOSEN MT 21 H=88mm	149
VERTEILERKASTEN MO		
RB10	ADAPTER FÜR DIN-LEISTE 35mm 1M	150
RB11	ADAPTER FÜR DIN-LEISTE 35mm 2M	150
RB20	VERTEILERKASTEN MO 12+2	151
RB21	VERTEILERKASTEN MO 24+4	151
RB22	VERTEILERKASTEN MO 36+6	151
RB23	VERTEILERKASTEN MO 48+8	151

ökonomik —

Typ	Bezeichnung	Seite
SCHALTER SE		
SE10	SCHALTER 1-POLIG 10AX 250V~	164
SE11	TASTER 1-POLIG 10A 250V~	164
SE22	SCHALTER 2-POLIG 16AX 250V~	164
SE50	SCHALTER SERIEN 10AX 250V~	164
SE51	TASTER SERIEN 10A 250V~	165
SE52	SCHALTER JALOUSIE 10AX 250V~	165
SE53	TASTER JALOUSIE 10A 250V~	165
SE60	SCHALTER WECHSEL 10AX 250V~	165
SE63	SCHALTER DOPPEL AUS/WECHSEL 10AX 250V~	165
SE70	SCHALTER KREUZ 10AX 250V~	165
SE10--	SCHALTER 1-POLIG 10AX 250V~	166
SE10--IN	SCHALTER 1-POLIG 10AX 250V~ IN	166
SE11--	TASTER 1-POLIG 10A 250V~	166
SE11--TI50	TASTER 1-POLIG 10A 250V~ TI 50	166
SE11--TI51	TASTER 1-POLIG 10A 250V~ TI 51	166
SE11--IL	TASTER 1-POLIG 10A 250V~ IL	166
SE22--NT03	SCHALTER 2-POLIG 16AX 250V~ NT 03	166
SE50--	SCHALTER SERIEN 10AX 250V~	167
SE51--	TASTER SERIEN 10A 250V~	167
SE52--NT09	SCHALTER JALOUSIE 10AX 250V~ NT 09	167
SE53--NT09	TASTER JALOUSIE 10A 250V~ NT 09	167
SE60--	SCHALTER WECHSEL 10AX 250V~	167
SE63--	SCHALTER DOPPEL AUS/WECHSEL 10AX 250V~	167
SE70--	SCHALTER KREUZ 10AX 250V~	167
WIPPEN TE		
TE10--	WIPPE NORMAL	168
TE10--	IN WIPPE NORMAL IN	168
TE13--	IL WIPPE MIT NAMENSCHILD IL	168
TE10--	TASTER SERIEN	168
BELEUCHTUNG IA		
IA10--	GLÜHLAMPE 230V~ 0,34 W	169
IA20--	LED-LAMPE 230V AC/DC 0,40 W	169
IA21--	LED-LAMPE 24V AC/DC 0,20 W	169
IA22--	LED-LAMPE 12V AC/DC 0,10 W	169
STECKDOSEN VE		
VE10--XO	STECKDOSE SCHUKO 2P+E 16A 250V~ XO	172
VE11--XO	STECKDOSE SCHUKO+KLAPPDECKEL 2P+E 16A 250V~ XO	172
VE12--XO	STECKDOSE SCHUKO 2P+E 16A 250V~ BV XO	172
VE13--	XO STECKDOSE SCHUKO+KLAPPDECKEL 2P+E 16A 250V~ BV XO	172
VE10--	STECKDOSE SCHUKO 2P+E 16A 250V~	172
VE11--	STECKDOSE SCHUKO+KLAPPDECKEL 2P+E 16A 250V~	172
VE12--	STECKDOSE SCHUKO 2P+E 16A 250V~ BV	172
VE13--	STECKDOSE SCHUKO+KLAPPDECKEL 2P+E 16A 250V~ BV	172
VE40--XO	STECKDOSE FRANZÖSISCH 2P+E 16A 250V~ XO	173
VE41--XO	STECKDOSE FRANZÖSISCH+KLAPPDECKEL 2P+E 16A 250V~ XO	173
VE42--XO	STECKDOSE FRANZÖSISCH 2P+E 16A 250V~ BV XO	173
VE43--XO	STECKDOSE FRANZÖSISCH+KLAPPDECKEL 2P+E 16A 250V~ BV XO	173
VE40--	STECKDOSE FRANZÖSISCH 2P+E 16A 250V~	173
VE41--	STECKDOSE FRANZÖSISCH+KLAPPDECKEL 2P+E 16A 250V~	173
VE42--	STECKDOSE FRANZÖSISCH 2P+E 16A 250V~ BV	173
VE43--	STECKDOSE FRANZÖSISCH+KLAPPDECKEL 2P+E 16A 250V~ BV	173
VE16--	STECKDOSE SCHUKO DOPPELT 2P+E 16A 250V~	174
VE46--	STECKDOSE FRANZÖSISCH DOPPELT 2P+E 16A 250V~	174
VE30--	STECKDOSE 2P 16A 250V~	174
KOMMUNIKATION KE		
KE11	STECKDOSE TV-R-ENDDOSE 2dB	175
KE12	STECKDOSE TV-R-DURCHGANGSDOSE 8,5dB	175
KE16	STECKDOSE SAT-TV-R-ENDDOSE 3dB	175
KE36	STECKDOSE TEL KS RJ11 6/4	175
KE37	STECKDOSE CAT5e KS RJ45 8/8	176
KE38	STECKDOSE TEL KS DOPPELT 2x RJ11 6/4	176
KE39	STECKDOSE CAT5e KS DOPPELT 2x RJ45 8/8	176
KE45	ADAPTER KS	176
KE46	ADAPTER KS DOPPELT	176
KE47	ADAPTER PD DOPPELT	176
KE10--	STECKDOSE TV-EINZELDOSE 0dB	177
KE11--	STECKDOSE TV-R-ENDDOSE 2dB	177
KE12--	STECKDOSE TV-R-DURCHGANGSDOSE 8,5dB	177
KE16--	STECKDOSE SAT-TV-R-ENDDOSE 3dB	177
KE22--	STECKDOSE AUDIO 2xRCA	177
KE23--	STECKDOSE AUDIO FÜR LAUTSPRECHER	177
KE36--	STECKDOSE TEL KS RJ11 6/4	178
KE37--	STECKDOSE CAT5e KS RJ45 8/8	178
KE38--	STECKDOSE TEL KS DOPPELT 2x RJ11 6/4	178
KE39--	STECKDOSE CAT5e KS DOPPELT 2x RJ45 8/8	178
KE35--	STECKDOSE TEL LT RJ11 6/4	178
DECKEL PA		
PE10--	DECKEL TV-R 2P/3P	179
PE20--	DECKEL KS EINFACH	179
PE21--	DECKEL KS DOPPELT	179
PE30--	DECKEL TAE/TDO	179

Typ	Bezeichnung	Seite
ELEKTRONIK EE		
EE15	DIMMER DREH-WECHSEL RL 400W	180
EE16	DIMMER DREH-WECHSEL RLC 400W	180
EE17	DIMMER DREH-WECHSEL FÜR LÜFTER 600VA	181
EE15--	DIMMER DREH-WECHSEL RL 400W	181
EE16--	DIMMER DREH-WECHSEL RLC 400W	181
DECKEL ELEKTRONIK PE		
PE40--	DECKEL FÜR DIMMER Ø4	183
PE41--	DECKEL FÜR DIMMER Ø6	183
ZUBEHÖR AE		
AE10--	BLENDE	184
AE20--	KAMMERANSCHLUSSDOSE 3P+N+E 5x4mm ²	184
AE30--	AUFPUTZGEHÄUSE NO 1	184
AE50--	TAPETENSCHUTZ	185
AE51--	KINDERSCHUTZ	185
RAHMEN OE		
OE10--	RAHMEN EKONOMIK 1	186
OE20--	RAHMEN EKONOMIK 2 HORIZONTAL	186
OE21--	RAHMEN EKONOMIK 2 VERTIKAL	186
OE30--	RAHMEN EKONOMIK 3 HORIZONTAL	186
OE31--	RAHMEN EKONOMIK 3 VERTIKAL	187
OE40--	RAHMEN EKONOMIK 4 HORIZONTAL	187
OE41--	RAHMEN EKONOMIK 4 VERTIKAL	187
OE90--	RAHMEN EKONOMIK DEKORATIV	187

fontana —

Typ	Bezeichnung	Seite
SCHALTER SF		
SF10--	SCHALTER 1-POLIG IP44 10AX 250V~	190
SF10--TI	SCHALTER 1-POLIG IP44 10AX 250V~ TI	190
SF11--TI	TASTER 1-POLIG IP44 10A 250V~ TI	190
SF20--	SCHALTER 2-POLIG IP44 10A 250V~	190
SF50--	SCHALTER SERIEN IP44 10AX 250V~	191
SF51--	TASTER SERIEN IP44 10AX 250V~	191
SF60--	SCHALTER SERIEN IP44 10AX 250V~	191
SF60--TI	SCHALTER WECHSEL IP44 10AX 250V~ TI	191
SF63--	SCHALTER DOPPELT AUS/WECHSEL IP44 10AX 250V~	191
SF70--	SCHALTER KREUZ IP44 10AX 250V~	191
STECKDOSEN VF		
VE10--	STECKDOSE SCHUKO+KLAPPDECKEL 2P+E 16A 250V~	192
VF12--	STECKDOSE SCHUKO+KLAPPDECKEL IP44 2P+E 16A 250V~ BV	192
SETS CF		
CF10--	SET STECKDOSE SCHUKO DOPPELT HORIZONTAL IP44 2x2P+E 16A 250V~	193
CF11--	SET STECKDOSE SCHUKO DOPPELT VERTIKAL IP44 2x2P+E 16A 250V~	193
CF12--	SET STECKDOSE SCHUKO+SCHALTER WECHSEL HORIZONTAL IP44 16A 250V~	193
CF13--	SET STECKDOSE SCHUKO+SCHALTER WECHSEL VERTIKAL IP44 16A 250V~	194
CF14--	SET STECKDOSE SCHUKO DOPPELT HORIZONTAL IP44 2x2P+E 16A 250V~ BV	194
CF15--	SET STECKDOSE SCHUKO DOPPELT HORIZONTAL IP44 2x2P+E 16A 250V~ BV	194
CF16--	SET STECKDOSE SCHUKO+SCHALTER WECHSEL HORIZONTAL IP44 16A 250V~ BV	194
CF17--	SET STECKDOSE SCHUKO+SCHALTER WECHSEL VERTIKAL IP44 16A 250V~ BV	194
ZUBEHÖR AF		
AF10--	ABZWEIGKASTEN IP44 RN01	195
AF20--	ABZWEIGKASTEN IP55 ND01	195

I N D E X





MODUL

— Funktionsmodule
function elements



54

Design
design

PURE
~~line~~
soft



96

Dosen
boxes



118

Vertrieb
distribution

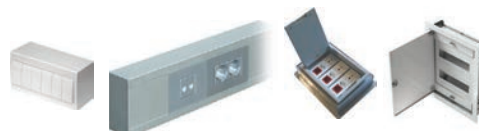

140

ekonomik —



164

fontana —



190





TEM

TEM ČATEŽ d.d.
Čatež 13, 8212 VELIKA LOKA
SLOVENIJA

tem@tem.si
www.tem.si

T +386(0)7 348 99 00
F +386(0)7 348 99 99

www.tem.si

DE
2014